

PowerBook G4 (15-inch Double-Layer SD)

19 October 2005



Basics

PowerBook G4 (15-inch Double-Layer SD)



General Information



Overview

From the exterior, the PowerBook G4 (15-inch Double-Layer SD) physically is identical to its predecessor, the PowerBook G4 (15-inch 1.67/1.5GHz). Both lack the customer accessible AirPort door in the battery bay.

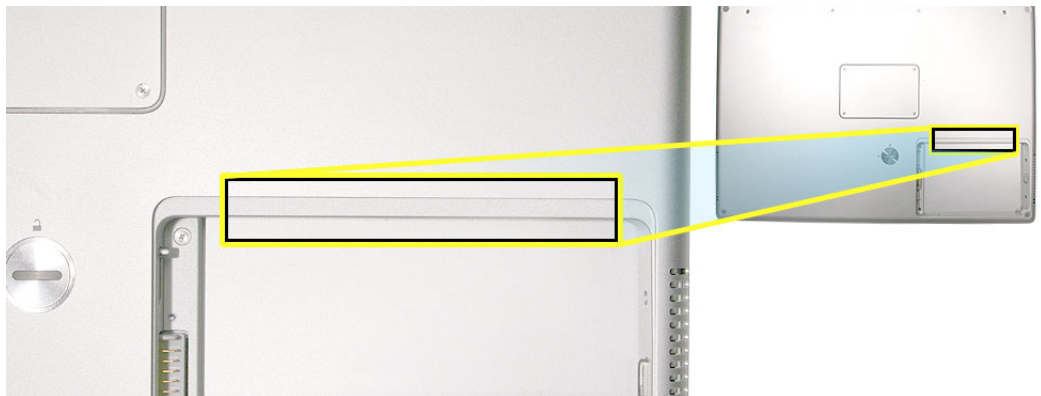

- The quickest ways to identify the PowerBook G4 (15-inch Double-Layer SD) computer:
- If the system is bootable, power it on. After pressing the power button the sleep LED light comes on solid and stays on until video appears onscreen.
 - Also the "About this Mac." Under Memory, shows DDR2 memory.



- Check a memory card to see if it is DDR2 (keyed differently than DDR)

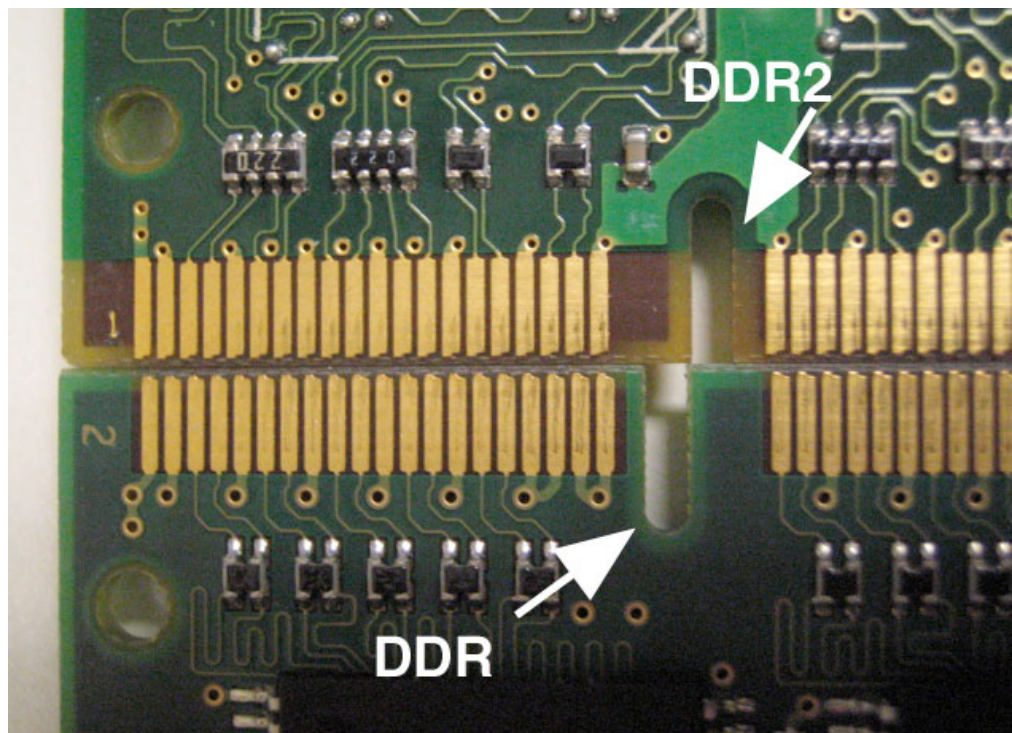

- With the top case removed, there is no mid-range speaker module (which has been above the hard drive on all previous aluminum PowerBook G4 15-inch models).

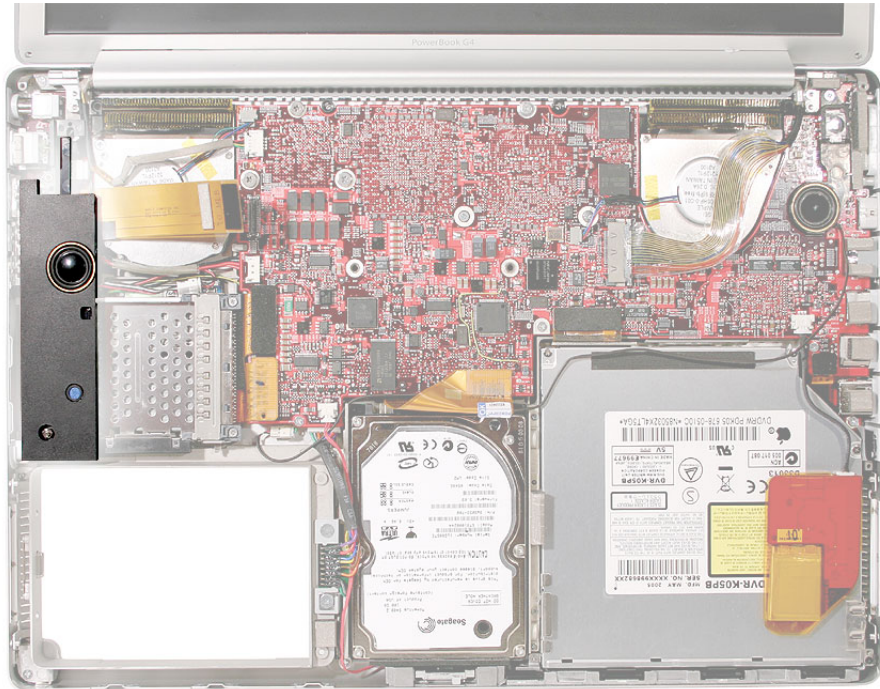

Main feature differences from the previous models:

- Higher resolution 15.2-inch display, 1440 x 960, 114 dpi (previously 1280 x 854, 101 dpi)
- Supports DDR2 memory up to 2GB
- 128MB VRAM with dual link DVI option is now standard
- Double-Layer SuperDrive allows users to burn two layers through a single side of a double-layer burnable disc.
- 80GB 5400 RPM hard drive standard
- 100GB/120GB 5400 RPM, 100GB 7200 RPM hard drive option

Some key features common to the two previous models that distinguish these computers from earlier PowerBook models, include:

- Aluminum alloy enclosure
- Built-in FireWire 800 port
- Supports USB 2.0

New Parts and Procedures

- Main Battery
 - The main battery has a new capacity sensing circuit design. It looks the same as previous batteries and is interchangeable. However, it has a different battery calibration procedure. A new calibration procedure has been developed which works on both batteries. Look in the Troubleshooting section, Battery Short Life for details. This change does not apply to the PowerBook G4 17-inch.
- Top Case
 - As the sleep magnet has been relocated to the display bezel, the sleep sensor has moved from the trackpad flex to the edge of the top case. Previous top cases will not work with this system.
- Keyboard
 - The keyboard has a narrower flex than the previous integrated backlight keyboard used in the PowerBook G4 (15-inch 1.67/1.5GHz). These two keyboards are not interchangeable. This keyboard is the same as on the PowerBook G4 (17-inch Double-Layer SD).
- Mass Storage (Hard drive and optical drive)
 - Both devices share a single ATA bus using a cable select addressing scheme. Previously each drive was a master device on separate ATA busses. Although, an older hard drive may work in this system, the optical drive will either not show up as a device or cause the system to not boot-up properly.
- AirPort Extreme and Bluetooth 2.0
 - These two functions have been combined on a single card.
 - The card has the antenna diversity function built-in, eliminating that card in the clutch cover.
- Main Logic Board
 - A new thermal grease is used. It has a greyish color.

Other minor differences include cable shapes, routing, connector types, locations, screws, brackets, and part designs.

Important Memory Note

Memory from previous 15-inch (Titanium-series) PowerBooks is not compatible with this computer.

Memory from previous PowerBook G4 (15-inch FW800), PowerBook G4 (15-inch 1.5/1.33GHz), and PowerBook G4 (15-inch 1.67/1.5GHz) is physically not compatible. DDR2 is keyed differently than DDR memory.

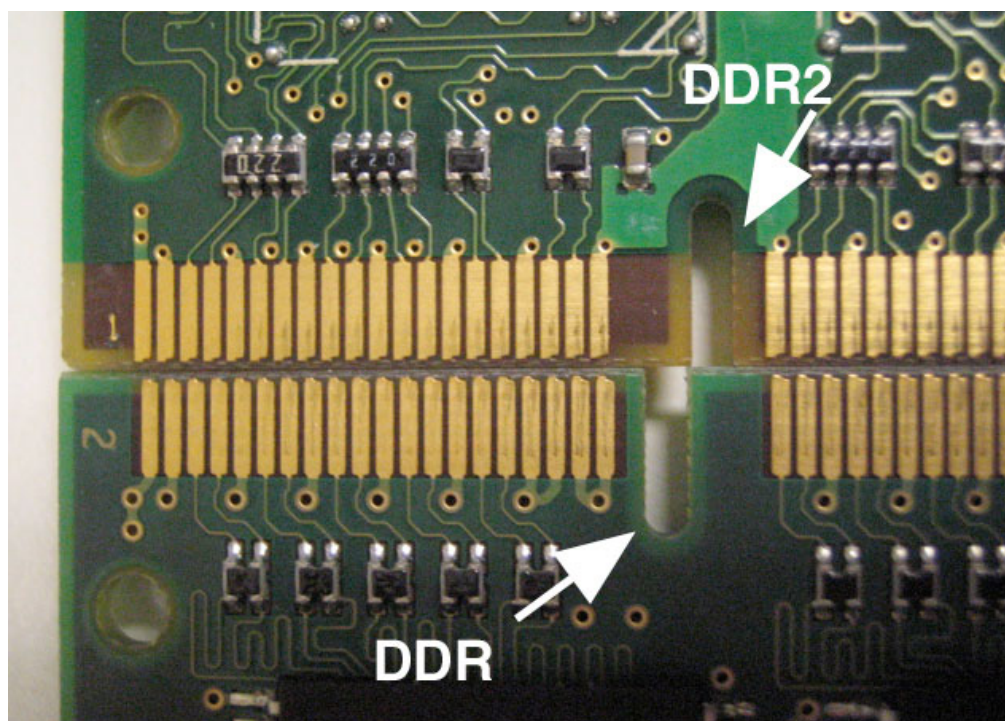

Service Manual Note

In this manual, graphics or photos are intended to help illustrate procedures or information, only, and may show a different level of disassembly, or show a different configuration or computer model, than your computer.

Kapton® Tape Note

See Kapton Tape topic below.

Cable Routing Note

During disassembly, note cable routing. Reassemble in the same manner. Verify that cables do not route over components when they should route into lower positions or channels. Verify that the cables are not strained or applying pressure onto other components.

Tools

The following tools are recommended for the take apart procedures.

- ESD wrist strap and mat
- Soft cloth
- #0 Phillips screwdriver (magnetized)
- #1 Phillips screwdriver (magnetized)
- 5 mm socket wrench
- 1.5 mm Hex key (or Torx T6)
- Needlenose pliers
- Torx T8 screwdriver
- Torx T6 screwdriver
- Thermal grease (922-7144)
- Gasket kit (076-1201)
- Alcohol pads
- Black stick (nylon probe tool 922-5065) (or other nonconductive nylon or plastic flat-blade tool)
- Multi-compartment screw tray (such as a plastic ice cube tray)
- Kapton tape (922-1731 (0.5-inch x 12-yard roll))
- Apple Pro keyboard and mouse (for troubleshooting)

Serial Number Location

The serial number is located in the battery bay.





Kapton Tape

Tools

This procedure requires the following tools:

- Kapton tape (922-1731 (0.5-inch x 12-yard roll))
- Scissors or tape dispenser

Procedure

Kapton tape is used to secure cables and connectors where necessary.

During disassembly, note any Kapton tape use and locations—reapply in the same manner. Do not over apply or build up tape on top of old tape; space tolerances are tight and build up or extraneous use of tape may cause pressure on other components.

Refer to the picture below throughout this manual as a guide to replacing Kapton tape.





Take Apart

PowerBook G4 (15-inch Double-Layer SD)



Foot



Tools

This procedure requires the following tools:

- Foot kit
- Tweezers or needlenose pliers
- Soft cloth

Preliminary Step

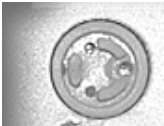
Before you begin, check the foot location that needs replacement and verify that the case plug is attached. Also verify that the case plug, and the case foot in the kit, match the pictures below.

Plug Area on Bottom Case	Matching Foot	Action
Missing case plug 	Not available for replacement	Replace the bottom case, or send to Apple Repair Center.
Case plug 	Case foot 	Continue with the procedure, matching the foot to the plug on the bottom case.

Procedure

Warning: The glue used in this procedure can bond instantly to skin. Do not touch the glue. In the event of contact, review the safety instructions at the end of this document. For additional information, refer to the glue manufacturer:

Elmer's Products, Inc.
Columbus, OH. 43215-3799
www.krazyglue.com

1. Place the computer upside down on a clean, lint-free cloth or other nonabrasive surface.
2. Select a foot from the kit. Verify that the case plug and case foot match (refer to the images shown in the table). Do not use a foot that does not match.
3. Make sure the plug area on the bottom case is clean. If any portion of the soft rubber foot remains, remove it so that only the hard plastic plug is visible.

Important: When positioning the foot, make sure the indents and bumps of the rubber foot match up and fit into the corresponding indents and bumps in the plug. This ensures a balanced and level fitting. (Note: The picture below is of a different foot than on the computer, and is for illustration only.)

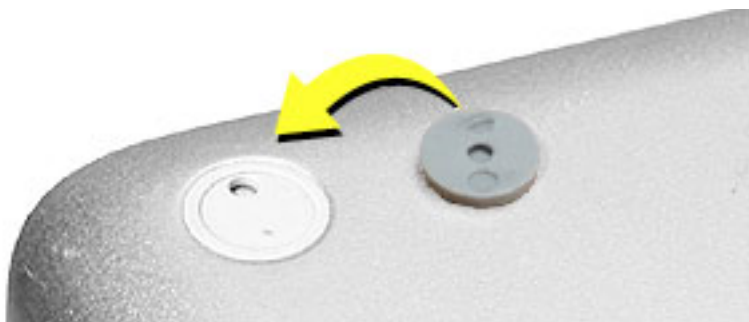

-
4. **Warning:** GLUE IS AN EYE AND SKIN IRRITANT. BONDS SKIN INSTANTLY. Do not touch the glue at any time. Before opening the glue, review the safety instructions at the end of this document.

Important: The glue tube included in the kit is sealed until first use. Do not break the seal until you are ready to use the glue. To break the seal, hold the tube upright and away from you. Place the hollow nozzle cap on the tube and tighten it all the way down. The tube is then ready to dispense the glue through the nozzle cap.



5. Apply one drop of glue to the plug on the bottom case. Do not spread the glue.
6. Using tweezers or needle-nose pliers, carefully position the new foot so its textured surface fits into the inner ring of the plug.
7. Using the end of the tweezers or pliers—not your finger—lightly press and hold the foot in place for 30 seconds.



8. Before turning over the computer, allow the glue to set for at least 15 minutes.
9. Discard the tube of glue.

SAFETY INSTRUCTIONS: GLUE IS AN EYE AND SKIN IRRITANT. BONDS SKIN INSTANTLY. Contains ethyl cyanoacrylate. Avoid contact with skin and eyes. If eye or mouth contact occurs, hold eyelid or mouth open and rinse thoroughly but gently with water only for 15 minutes and GET MEDICAL ATTENTION. Liquid glue will sting eye temporarily. Solidified glue may irritate eye like a grain of sand and should be treated by an eye doctor. If skin bonding occurs, soak in acetone-based nail polish remover or warm soapy water and carefully peel or roll skin apart (do not pull). Contact through clothing may cause skin burn. If spilled on clothing, flush with cold water. Avoid prolonged breathing of vapors. Use with adequate ventilation. KEEP OUT OF REACH OF CHILDREN.



Battery

Tools

This procedure requires the following tools:

- Soft cloth
- Coin

Part Location



Preliminary Steps

Warning: Always shut down the computer before opening it to avoid damaging its internal components or causing injury. After you shut down the computer, the internal components can be very hot. Let the computer cool down before continuing.

Procedure

Warning: If the computer has been recently operating, allow it to cool down before performing this procedure.

1. Shut down the computer.
2. Disconnect the power cord and any other cables connected to the computer.
3. Place the computer face down on a soft cloth.
4. Insert a coin in the battery lock slot and turn it one quarter turn clockwise. The battery should raise up slightly. Lift the battery out of the battery bay.





Memory Door and Memory Cards

Tools

This procedure requires the following tools:

- Soft cloth
- #0 Phillips screwdriver

Part Location

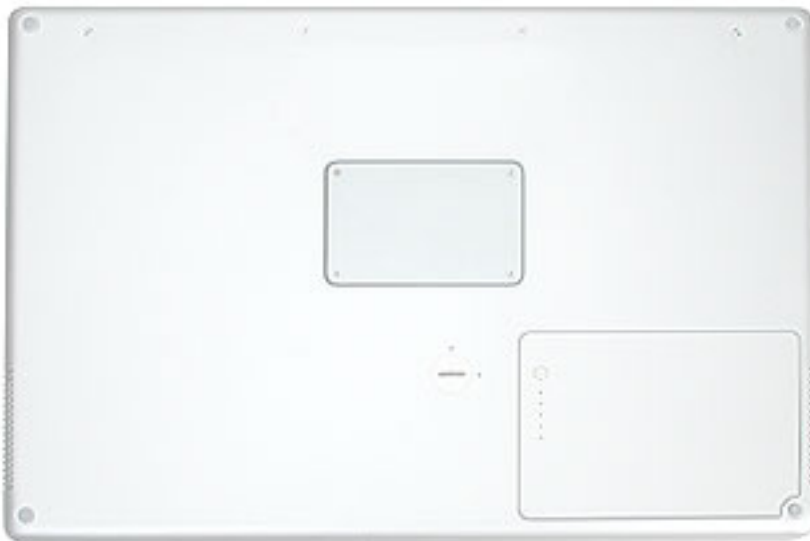

Preliminary Steps

Before you begin, remove the battery.

Procedure

Warning: If the computer has been recently operating, allow it to cool down before performing this procedure.

1. Place the computer face down on a soft cloth.
2. Remove the four screws from the memory door then remove the door.

922-6091



3.4 mm

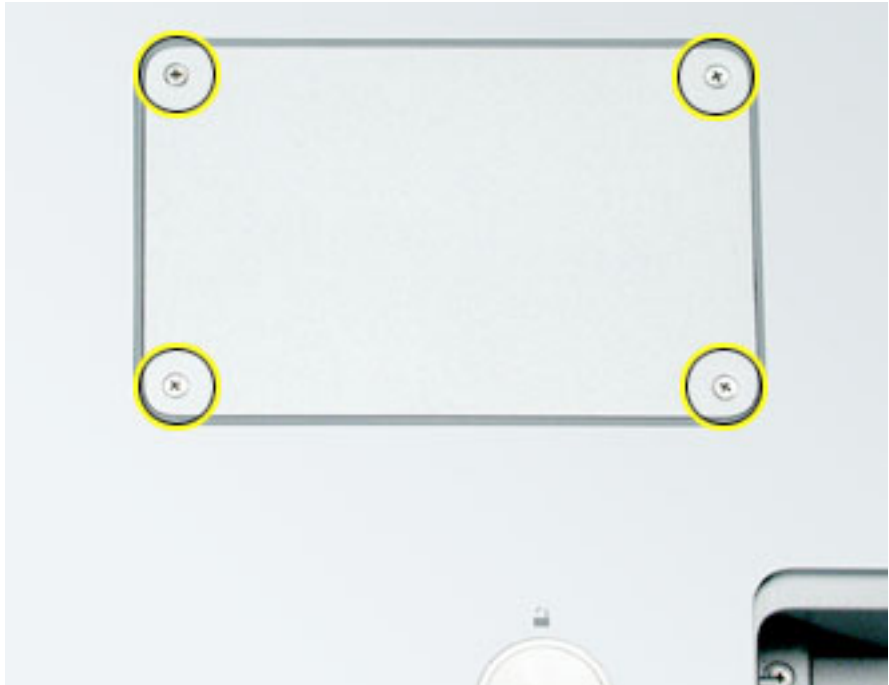

Note: If only one memory card is installed, the factory installs it in the bottom memory slot.

Note: Memory must be removed from the top slot before removing from the bottom slot.

3. To remove memory cards, carefully spread the two locking tabs for the slot (top or bottom) away from the card on both sides and allow the card to pop up slightly.



4. Pull the card straight back and out of the memory slot.



Replacement Procedure

Notes:

- DDR memory cards do not fit in this slot (different notch location).
 - The top and bottom memory cards are inserted at different angles.
 - If installing two cards, install into the bottom slot first.
 - Align the notch in the memory card with the tooth in the slot before inserting.
1. To install a memory card into the bottom slot, insert the card at a low angle behind the locking tabs of the top slot.

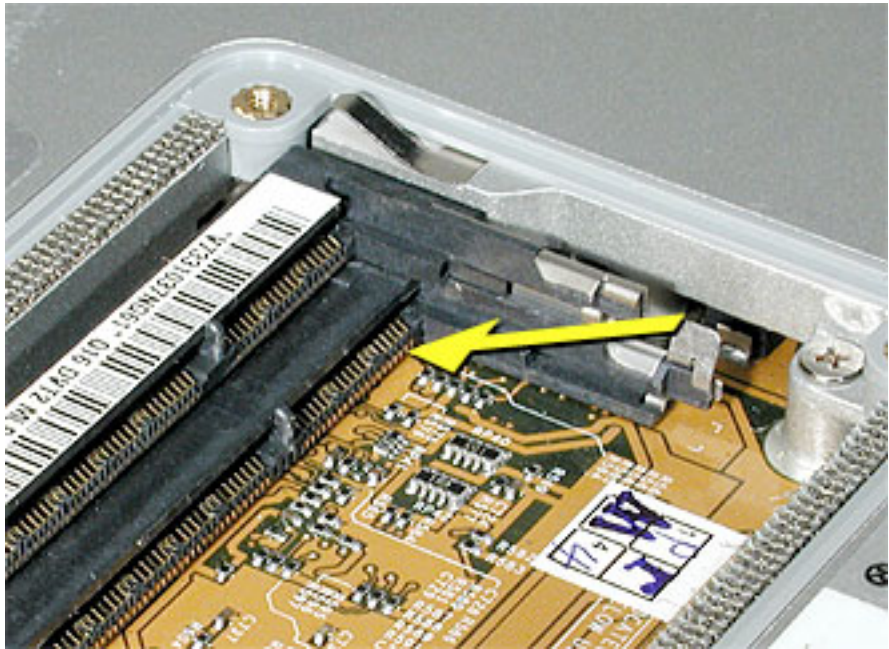

- Slide the card forward to the lower slot. Firmly push the card straight into the slot until it is fully and securely seated along its length.

Note: If the back of the card drops down before it is fully seated, raise it up enough to push it fully into the slot.

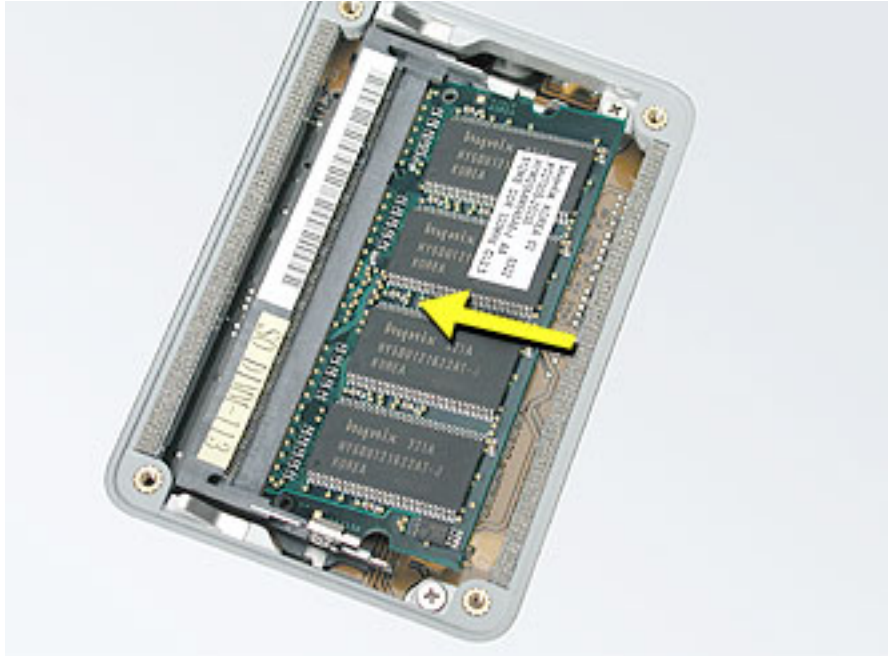

- Carefully spread the two locking tabs for the bottom slot away from the card on both sides while pushing the card straight down until the tabs click onto both sides of the card, locking it into place.

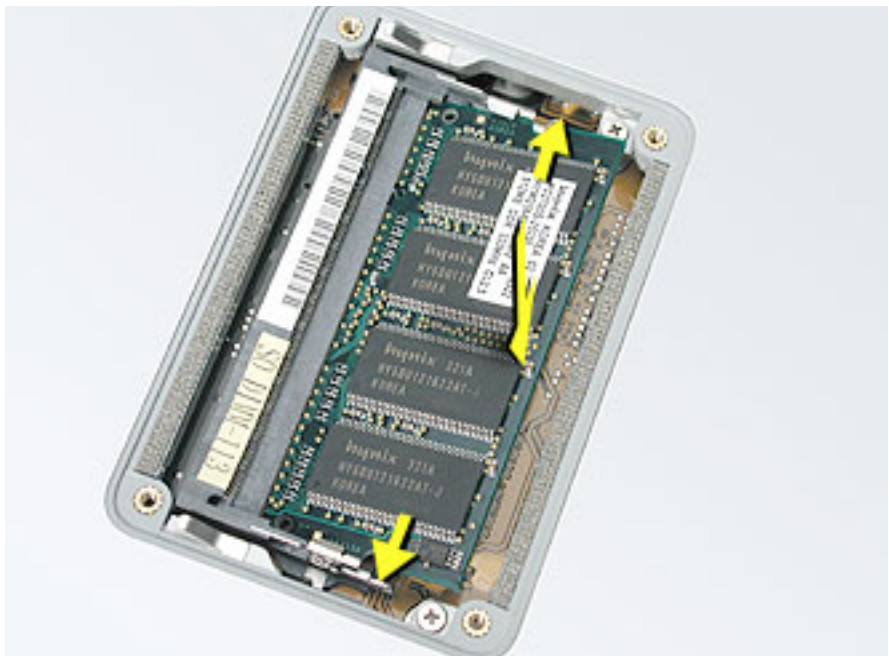

7. Cards should be flat and secure on both sides.



8. Install the memory door.
9. Replace the battery.
10. Use Apple System Profiler to verify that the memory is recognized. (Choose the menu bar Apple logo (🍏) > About This Mac, click More Info..., select the System Profile tab, open the Memory Overview.)



Top Case

Tools

This procedure requires the following tools:

- #0 Phillips screwdriver (magnetized)
- 1.5 mm Hex key (or Torx T6)
- Black stick (or other nonconductive nylon or plastic flat-blade tool)
- Soft cloth
- Multi-compartment screw tray

Part Location



Preliminary Steps

Before you begin, remove the following:

- Battery
- Memory door

Procedure

Note: This procedure removes the top case and keyboard assembly. The keyboard is removable only after removing the top case.

1. Place the computer face down on a soft cloth.
2. Remove the two screws inside the battery bay.
3. Remove the two screws from the memory bay.
4. Remove the four screws along the back edge.

922-6095



16.4 mm

922-6719



12.6 mm

922-6091

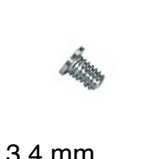

3.4 mm



5. With the display open, rest the computer on one side. Remove the three screws.

922-6091



3.4 mm



6. Turn over the computer and remove the three screws on the other side.

922-6091



3.4 mm



7. Open the computer slightly and rest it with the back facing up. Remove the two top screws along the back.

Note: Do not remove the bottom screws.

922-6100



5.3 mm



8. Lay the computer right side up and open the display slightly past 90-degrees.
9. Remove the two hex screws at the back corners of the top case (a Torx T6 can also be used).

922-6096

1.5 mm Hex



4.4 mm



10. Along the left side, near the back, insert a black stick into the space between the top and bottom case. Work the black stick forward with a twisting motion until the black stick can be inserted on the left side of the front.

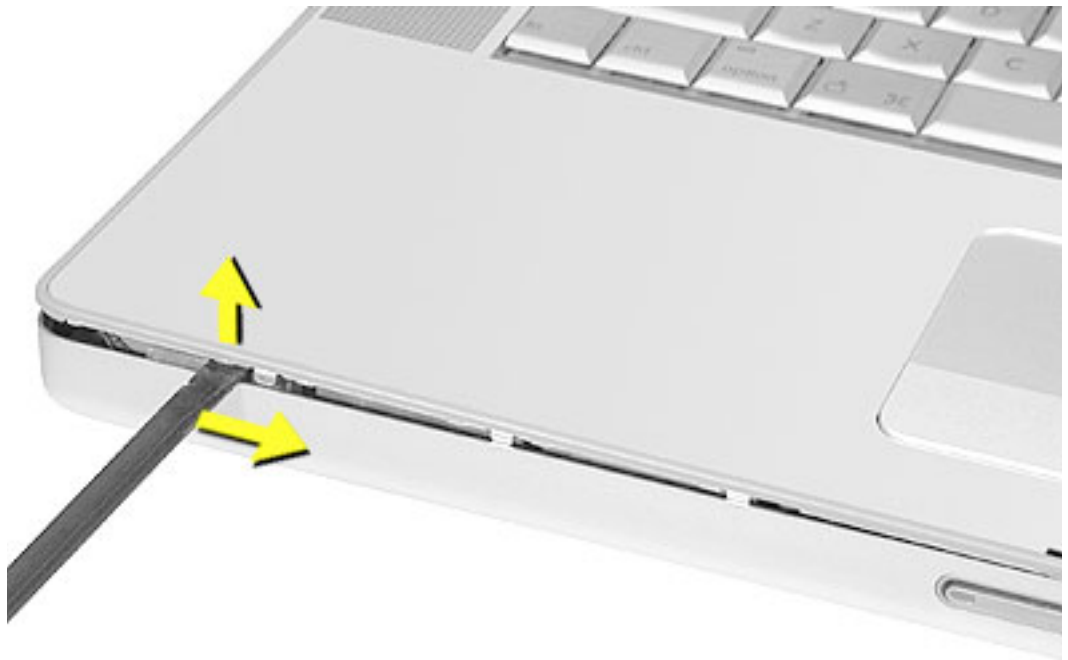

11. Loosen the back right side, if needed.

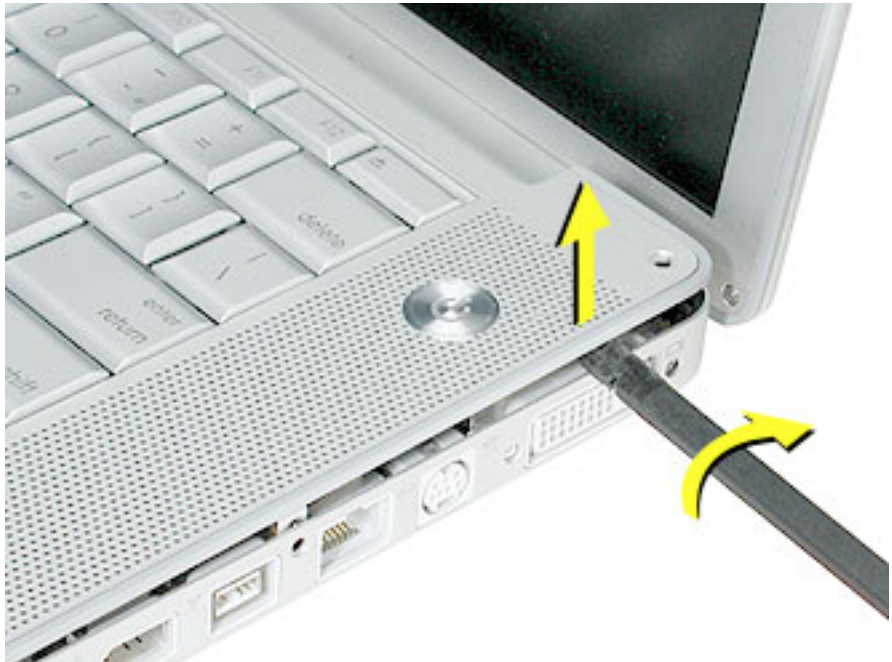

12. Work the left side up until the four catches over the optical drive slot release along the right side, then lift the top case straight up, slightly, to release it completely, but do not remove.



- Lift the front of the top case and pivot along the back edge to about 45-degrees, to expose the keyboard flex cable connected to the logic board.

Important: Do not lift off the top case or strain the keyboard flex cable.



- Remove any Kapton tape from the keyboard connector on the logic board, then use a black stick to disconnect the flex cable. Lift off the top case.

Replacement Note: When reinstalling, reapply Kapton tape where it was removed.

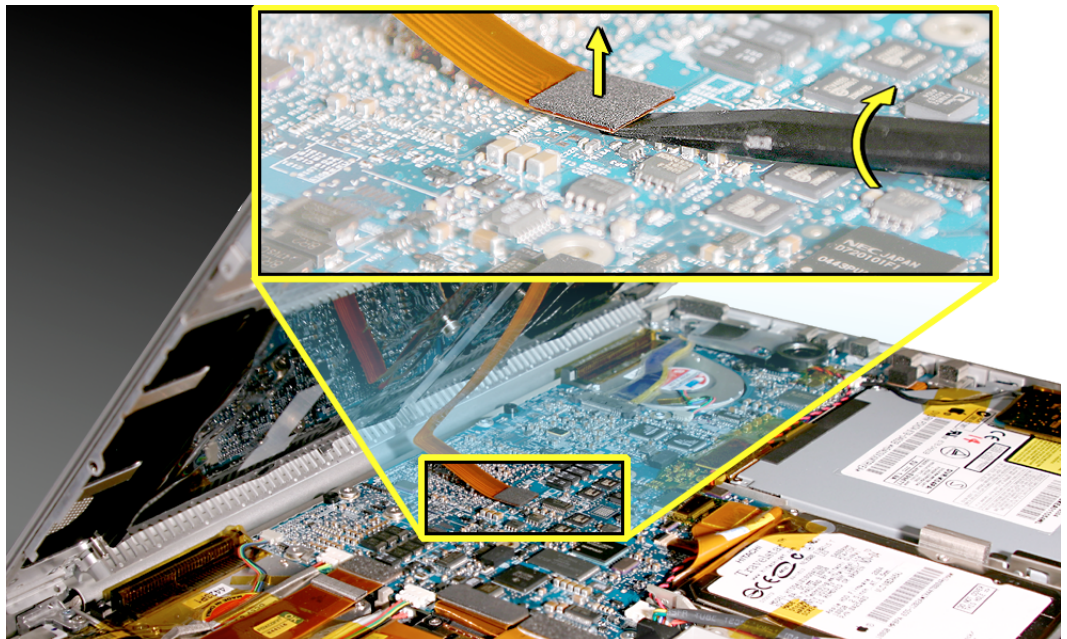

Replacement Procedure

Note: If replacing the top case, remove the keyboard and transfer to the replacement top case.

1. Visually check to verify that all cables are connected and routed correctly with nothing raised up or incorrectly over a component.
2. Check perimeter wiring and cables around clutches to verify that they will not be caught or pinched by the top case during replacement.
3. Verify that the LVDS cable is secure and lays flat.

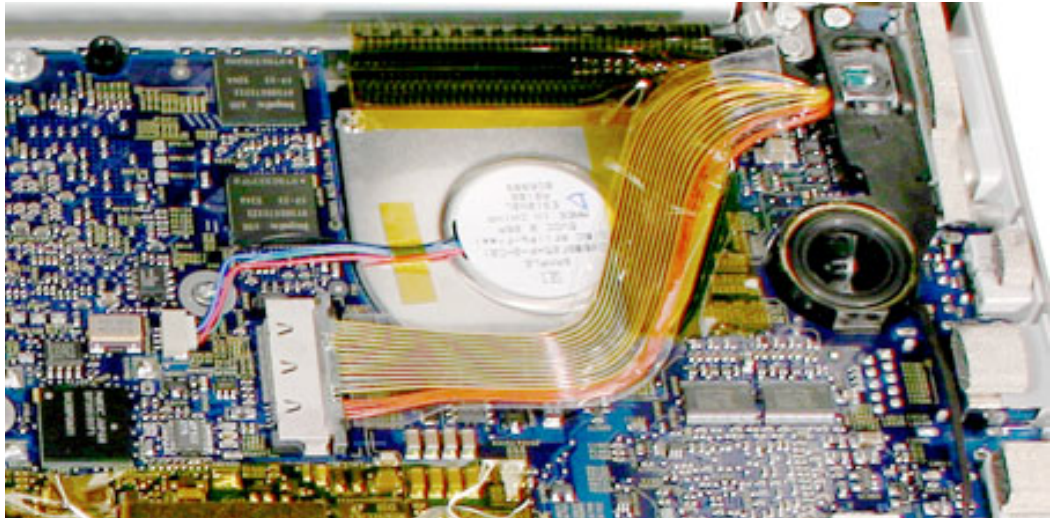

4. On the top case, check cable connections and routing.

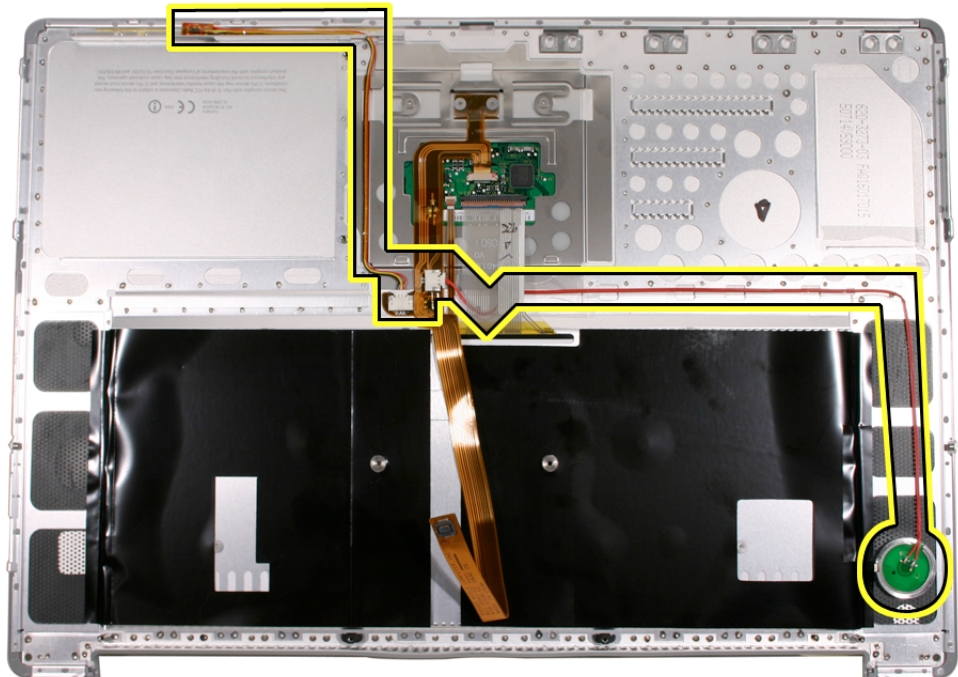

5. Check that the perimeter metal tabs are not bent.

Note: The metal quickly fatigues and can break off easily. Be extremely careful to gently straighten tabs, if needed.

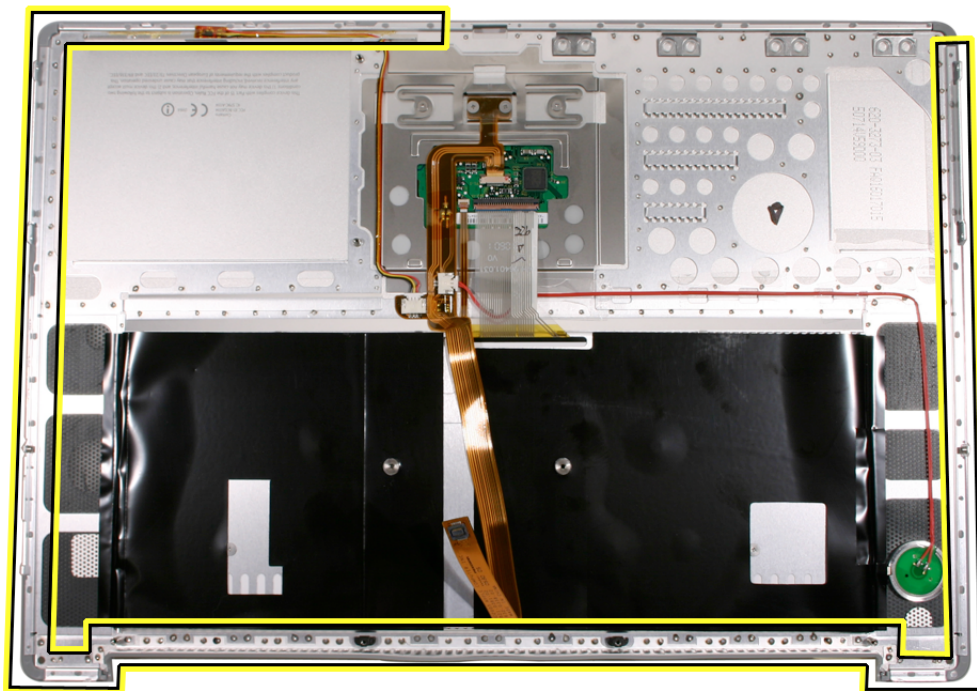

6. Connect the flex cable from the top case to the logic board.
7. Lift the top case slightly and rotate it down over the bottom case (verify that the cable is folding properly) and align the corners.
8. Start at the right corner and guide the top case onto the bottom case. Use a black stick to carefully pull or push tabs slightly, if needed.

Important Notes:

- Some side screws have a flexible screw boss. If they block a tab on the top case from seating, use the pointed end of a black stick through the screw hole to push on the boss slightly.
 - The tabs are fragile. Do not apply too much pressure or bend them.
 - The top case should lay flat along the sides and top, if not, make sure that cables and components are not interfering.
 - Screw order is vital for the proper attachment of the top case.
9. Reinstall the side screws in the order shown, below.

Replacement Note: Do NOT insert side screws into the DVI port screw holes. The screws can jam in the holes, requiring removing the logic board to remove.

922-6091



3.4 mm



922-6091



3.4 mm



10. Close the computer, flip it over, and install the four back screws.
11. Install the two screws in the memory bay.
12. Install the memory door and four screws.
13. Install the two screw in the battery bay.

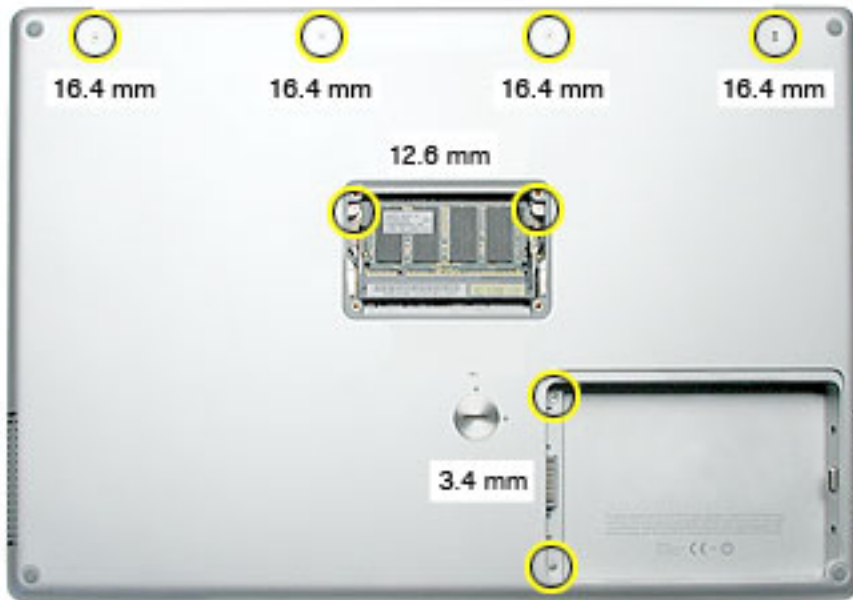
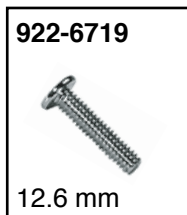

14. Replace the battery.
15. Testing the computer should include powering on, checking the keyboard and trackpad function.
Operate the computer in a darkened room to check for keyboard backlight function.



Keyboard

Tools

This procedure requires the following tools:

- #0 Phillips screwdriver
- Black stick (or other nonconductive nylon or plastic flat-blade tool)
- Kapton tape

Part Location



Preliminary Steps

Before you begin, remove the following:

- Battery
- Top case

Procedure

Keyboard for the PowerBook G4 (15-inch Double-Layer SD) and (15-inch 1.67/1.5GHz) computers have different construction, and removal and installation procedures than previous models.

Important Notes:

- The PowerBook G4 (15-inch Double-Layer SD) keyboards are not interchangeable with previous models. Verify that the correct replacement keyboard is ordered, and/or top case if replacing.
- The keyboard comes as a multi-layered assembly, and all include backlighting. Do not disassemble the keyboard assembly. Dust, fingerprints, or misalignment, can cause improper function and damage.

1. On a clean flat surface, turn the top case upside down, with the keyboard side nearer to you.
2. Locate the keyboard flex cable connectors. Also, note the location and remove any Kapton tape.

Replacement Note: Kapton tape must be installed in the same manner during reassembly.

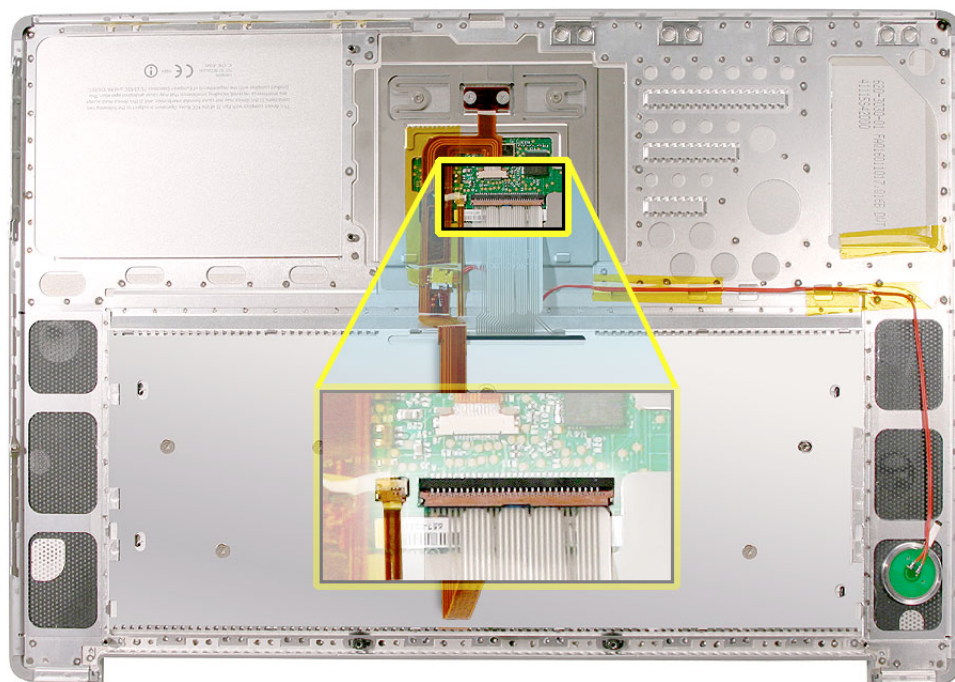

3. Very carefully lift the front of the two connectors to release the keyboard flex cables, as shown.

Important: The connectors are delicate. If damaged, the top case must be replaced.

Replacement Note: Verify that the cables are fully inserted and secured straight.

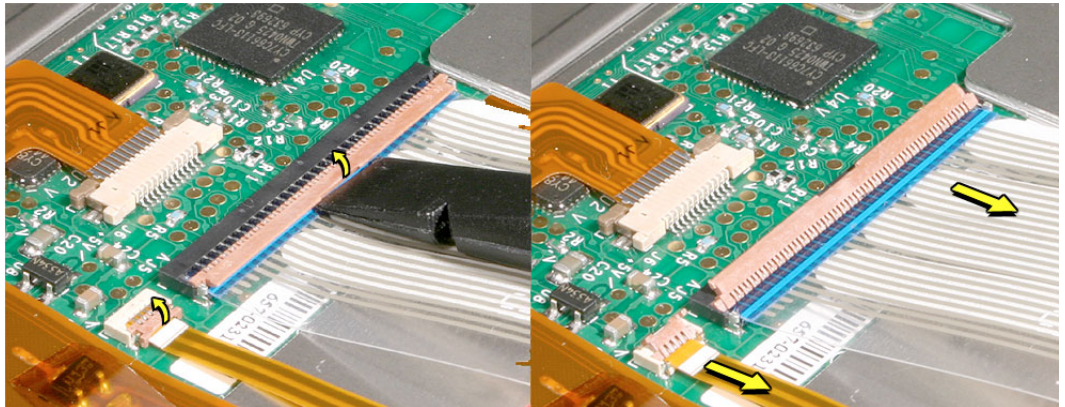

4. Note the position, then carefully peel off the insulator film covering the back of the keyboard well. Reserve the film and keep it clean for reinstallation.

Note: The film may be a different color and design than shown here.

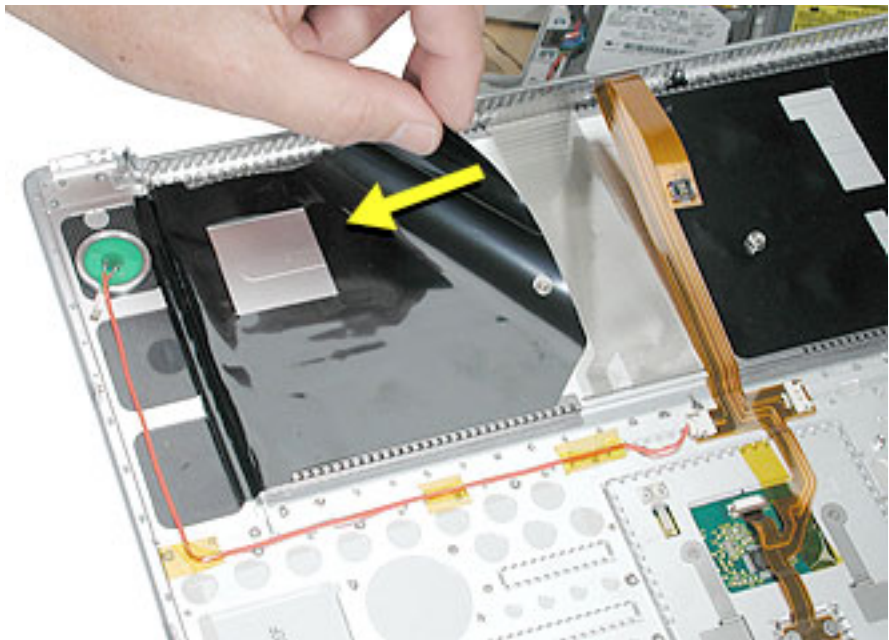

5. Use needlenose pliers to straighten the four bend-tabs located along the bottom edge, as shown. These tabs lock down and stiffen the top edge of the keyboard.

Important: The bend-tabs are delicate. Bend them carefully to avoid damage. Avoid overbending.

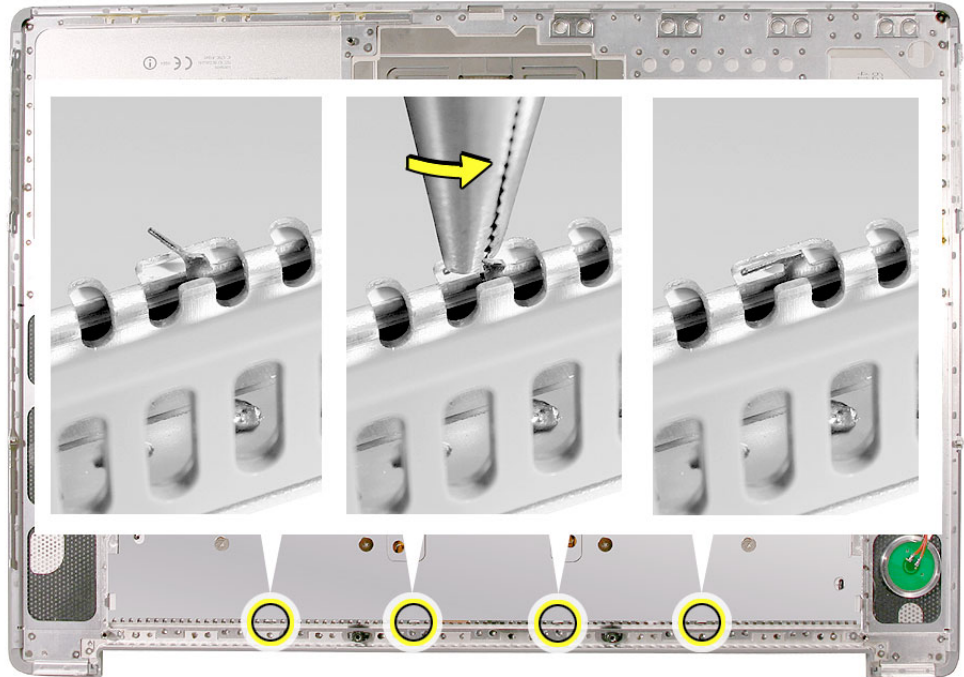

6. Remove the ten keyboard screws.

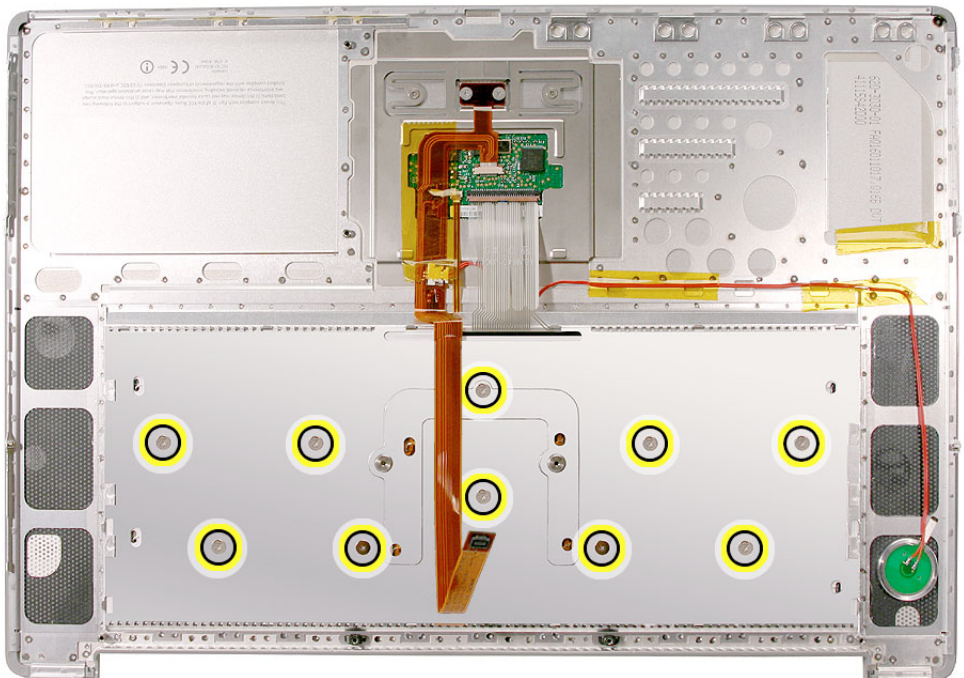

- Note the six insert-tabs along the middle edge, and two on each side. The following procedures release these tabs so that the keyboard can be removed.

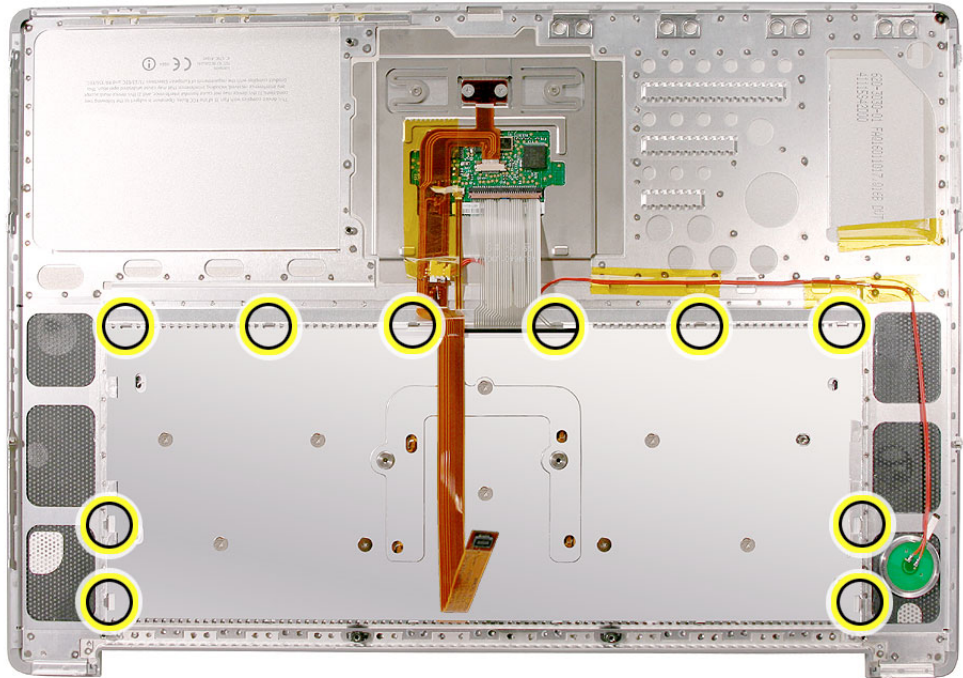

- To prevent the keyboard from falling out, support it with your hand, and raise the top case up vertically.

Note: The keyboard does not have adhesive under it, as in previous models.



9. If needed, push through one of the top center keyboard screw holes, with the point of a black stick, to bow out the keyboard slightly.

Important: Ensure that the hole used is a screw hole, or damage to other sensitive components may result. A black stick is used to avoid damaging the screw boss threads—do not use a metal tool.



10. **Important:** During this procedure, do not allow the tabs or metal edge of the keyboard to scrape along the cosmetic surface of the top case, or damage can result.



11. Use your finger to hold the bowed out keyboard. Continue to bow it out only enough for the tabs on one side of the keyboard to release cleanly. Repeat for the other side.

Important: Do not bow the keyboard too much, or it may become permanently bent.



12. Lift the keyboard up to release the tabs along the bottom edge and carefully thread out the flex cables.

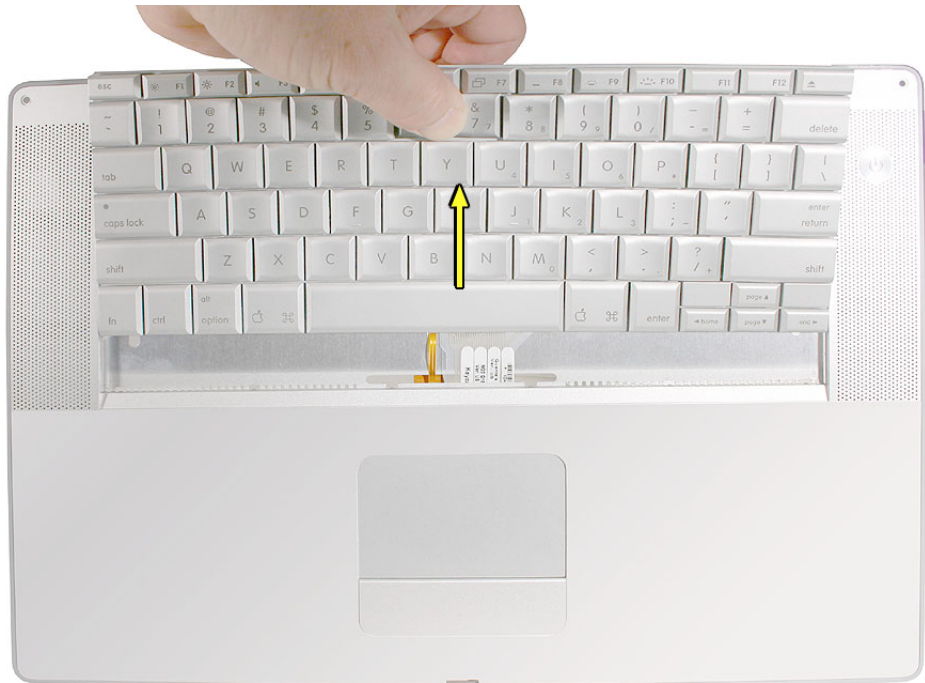

Replacement Procedure

When replacing the keyboard, here are some key points to ensure:

- Prevention of scratches to the cosmetics of the top case
 - All tabs are properly seated
 - Keyboard lays flat
 - Cables not caught
 - Bend-tabs are not damaged
 - Screw holes align
 - Cable connectors are not damaged and cables secure properly
 - Kapton tape is applied as before
 - Insulator film is correctly installed
1. Before replacing or installing a replacement keyboard, verify that the four bend-tabs along the bottom edge of the keyboard, are straight and parallel with the bottom edge.

Important: Do not bend any other bend-tabs on the keyboard other than the four along the bottom. Other tabs hold the keyboard assembly together.

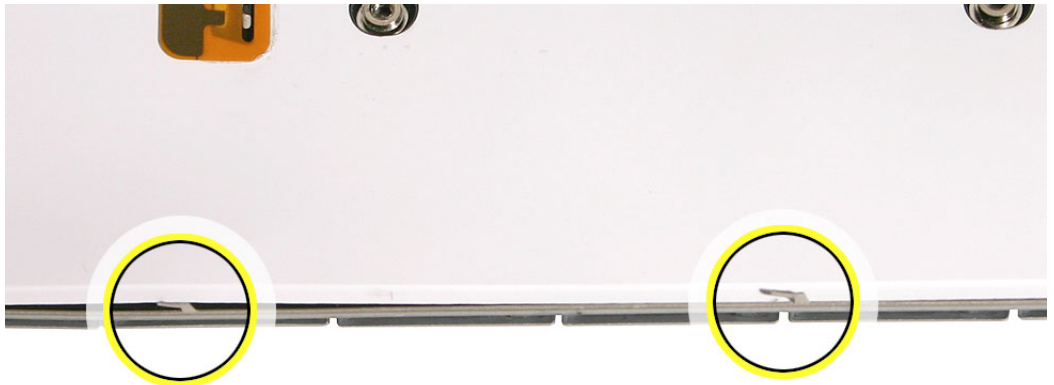

2. Guide the keyboard's flex cables through the slot in the top case, as shown. Make sure that they do not catch or bend behind the keyboard.

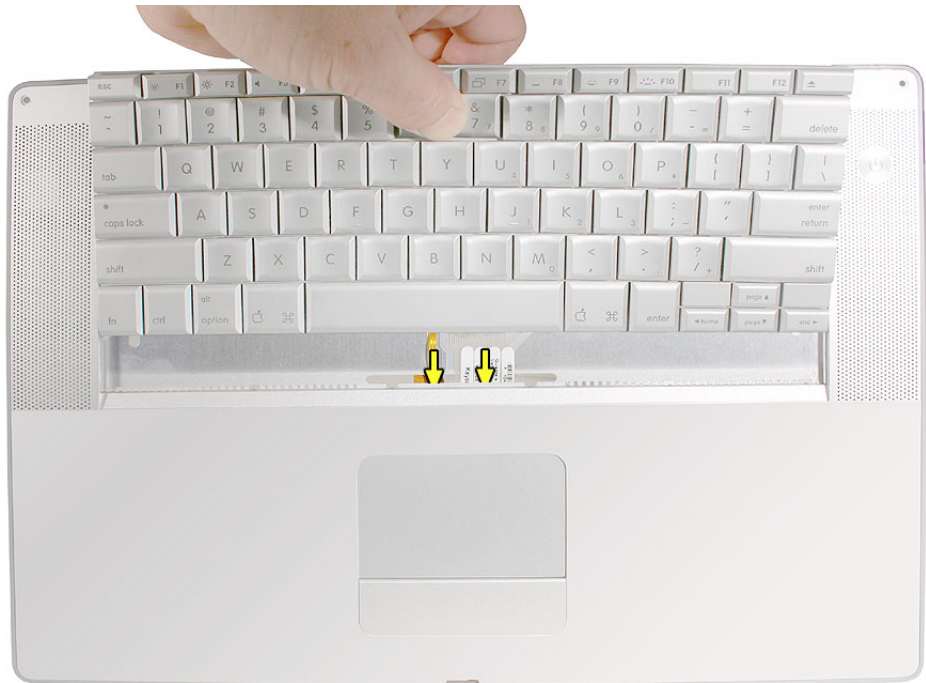

3. Lower the keyboard and seat all six tabs along the bottom, so that the keyboard sits flat and straight.



Important: During the next steps, do not allow the tabs or metal edge of the keyboard to scrape along the cosmetic surface of the top case, or damage can result.

4. While ensuring that the keyboard bottom stays straight and secure, hold the top of the keyboard in the middle, then with your other hand, bow in one side of the keyboard to engage the two tabs at the top into the top case.

Important: Do not bow the keyboard too much, or it may become permanently bent.



5. Use the heel of your hand to hold in place the edge of the keyboard that was just inserted while holding the top of the keyboard with a finger on that hand, then use your other hand to help bow in the remaining side of the keyboard until it can be engaged.



6. While supporting the keyboard in the top case, verify that the keyboard lays flat and that all the tabs have seated properly.

Note: The keyboard will not sit flat if any of the tabs have not seated properly. If the side tabs are not seating or are binding, check the bottom edge of the keyboard to verify that all the tabs are seated and the bottom of the keyboard is straight.

7. Verify that the bend-tabs are not caught.
8. Lay the top case flat, and upside down.
9. Pull on the flex cables to verify that they are not bent or caught under the keyboard, and that they extend to their connectors.
10. Verify that the screw holes align with the screw bosses and install all ten keyboard screws, starting from the middle and work out.
11. Bend the four bend-tabs over the metal of the bottom case to secure the bottom edge of the keyboard.

Important: The bend-tabs are delicate. Bend them carefully to avoid damage and no more than 90-degrees, or to, or within, any etch marks, if present. Avoid over bending.

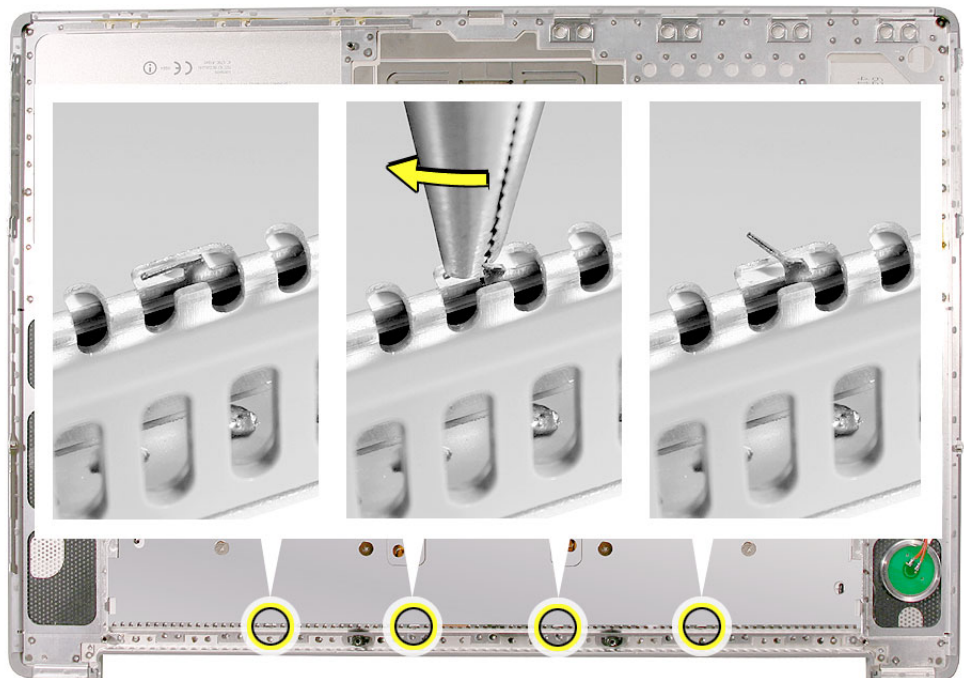

12. Insert the flex cables into their connectors and secure. Install Kapton tape in the same location as it was removed.
13. Replace the insulator film in the same locations as they were removed. Ensure the holes in the film match up correctly with the screw bosses. Avoid wrinkles and bulges. If installing a replacement top case, use the new film if supplied.

Important: The film must be installed and in the same location to protect against contact and electrical shorting in certain areas and to allow contact with the EMI spring on the logic board.

14. If the film extends over the edge of the keyboard well, run your finger along the edges to secure it to the top case.

Note: Picture for illustration only. The insulator film may be different.

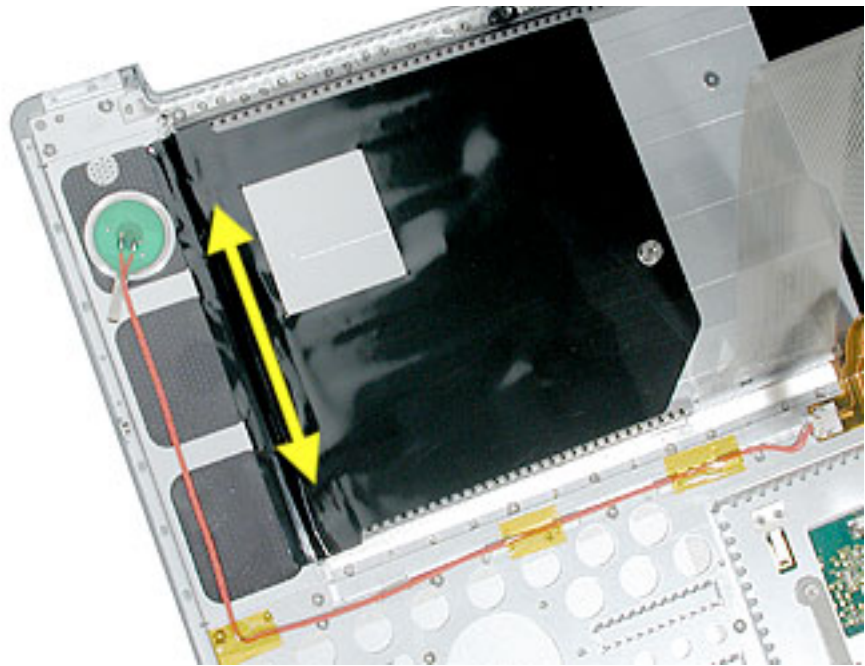

15. Reassemble the computer.
16. Testing the computer should include powering on, checking the keyboard and trackpad function.

Operate the computer in a darkened room to check for keyboard backlight function, and light leakage around the perimeter of the keyboard, speaker grill openings and side ports.



Backup Battery

Tools

This procedure requires the following tools:

- Black stick (or other nonconductive nylon or plastic flat-blade tool)

Part Location

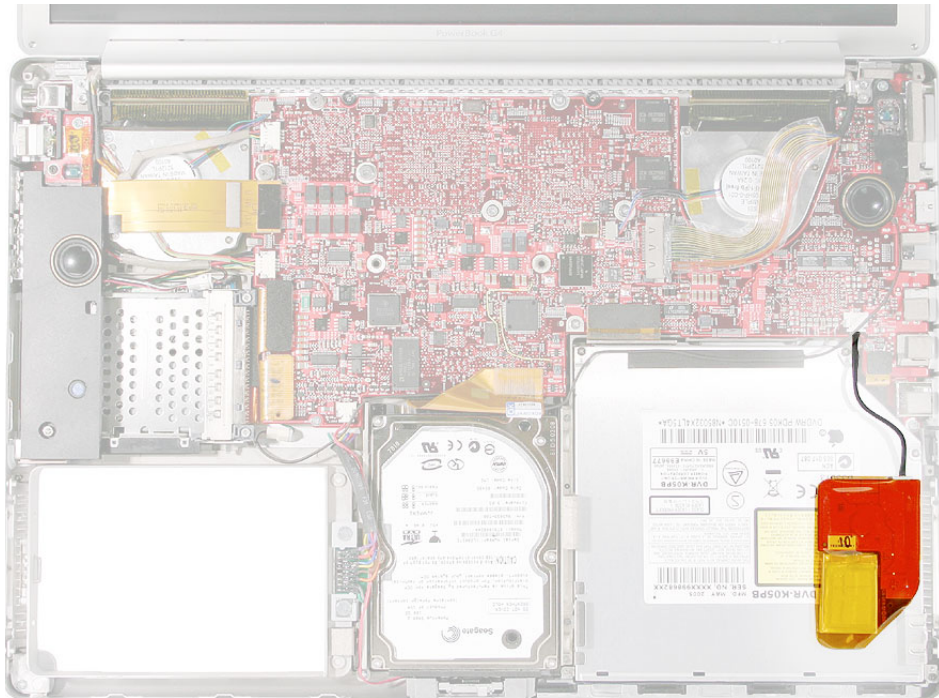

Preliminary Steps

Before you begin, remove the following:

- Battery
- Top case

Procedure

Note: Previous model battery shown.

1. Use a black stick to release the adhesive holding the backup battery to the optical drive then disconnect the backup battery cable.

Note: The backup battery is held down by double-backed tape adhesive on its cover.



Replacement Procedure

1. Connect the backup battery cable to the backup battery and to the logic board.
2. Remove any protective adhesive cover on the replacement backup battery.
3. Position the backup battery precisely to the dimensions shown below.

Note: Measurements are from the edge of the optical drive and the optical drive bracket to the backup battery board and the battery (not the protective cover).

Important: If the backup battery is not positioned correctly, sharp edges on the top case, and on the optical drive bracket, may cause damage.



4. Press where shown to secure the backup battery to the optical drive.



5. Reassemble the computer.
6. Testing the computer should include plugging in the power adapter and letting the backup battery charge for half an hour. Then power on the computer and disconnect the power adapter, set the system clock, put the computer to sleep, remove the main battery for five seconds and reinstall. The date and time should not reset.
Also, insert an optical disc to verify that the optical drive functions properly.



Battery Connector

Tools

This procedure requires the following tools:

- #0 Phillips screwdriver (magnetized)
- Black stick (or other nonconductive nylon or plastic flat-blade tool)

Part Location

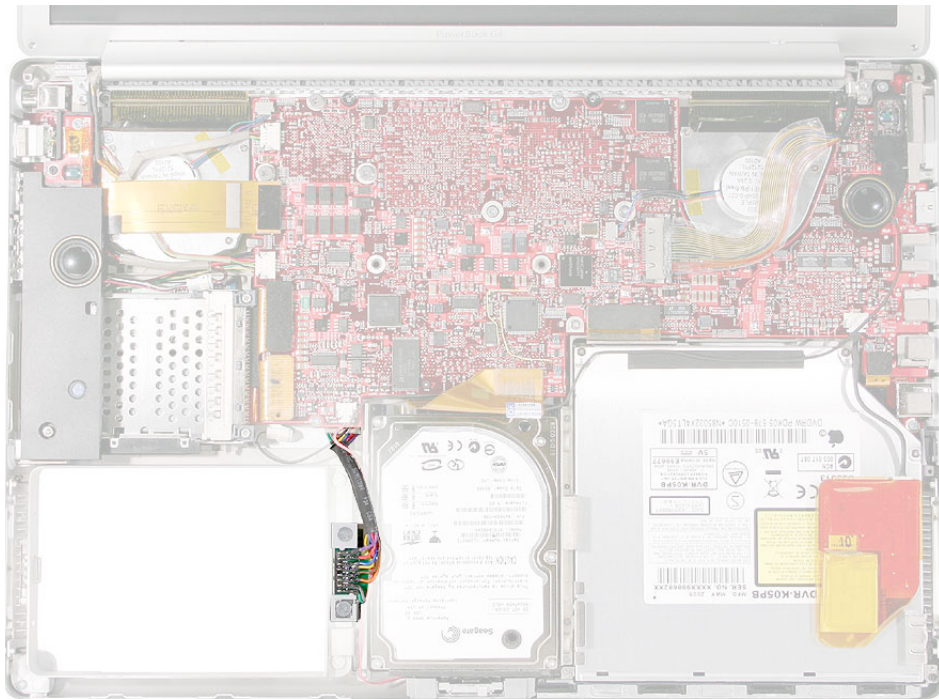

Preliminary Steps

Before you begin, remove the following:

- Battery
- Top case

Procedure

1. Remove three screws.

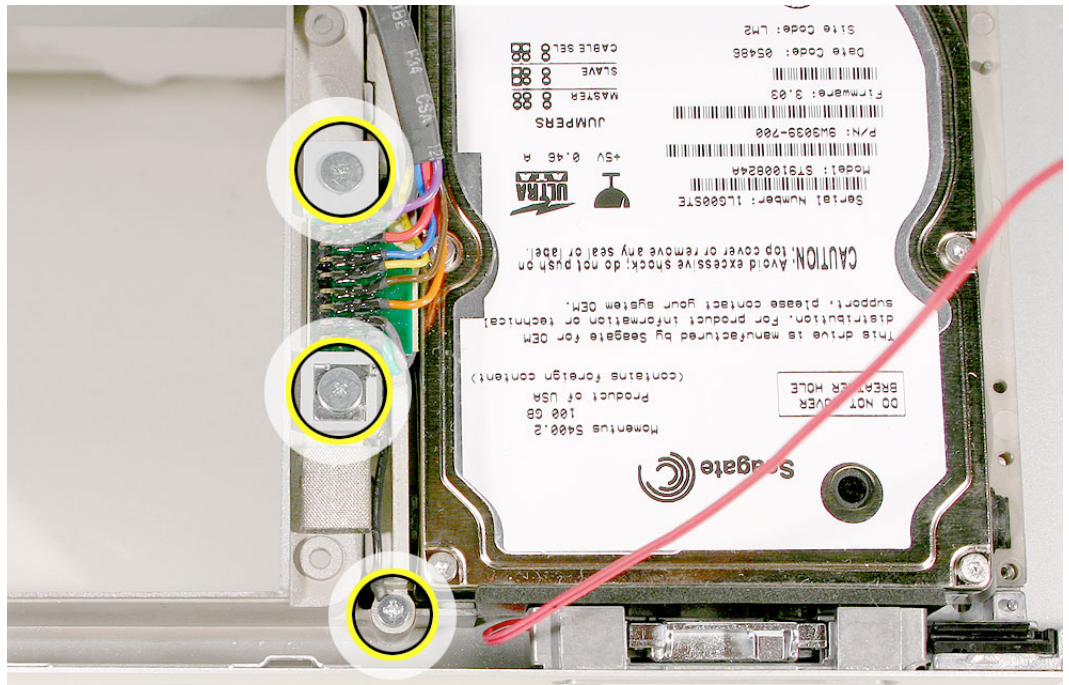
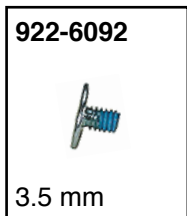

2. Install the battery connector and ground screw lead.

Note: Do not overtighten the two main battery connector screws. There will be play in the battery connector when the screws are secured.

3. Connect the main cable to its connector on the underside of the logic board.
4. Reassemble the computer.
5. Testing should include plugging in the power adapter and battery charging, then running the computer from battery power. Verify that the sleep LED functions properly.



Left Blower

Tools

This procedure requires the following tools:

- #0 Phillips screwdriver (magnetized)
- Black stick (or other nonconductive nylon or plastic flat-blade tool)

Part Location

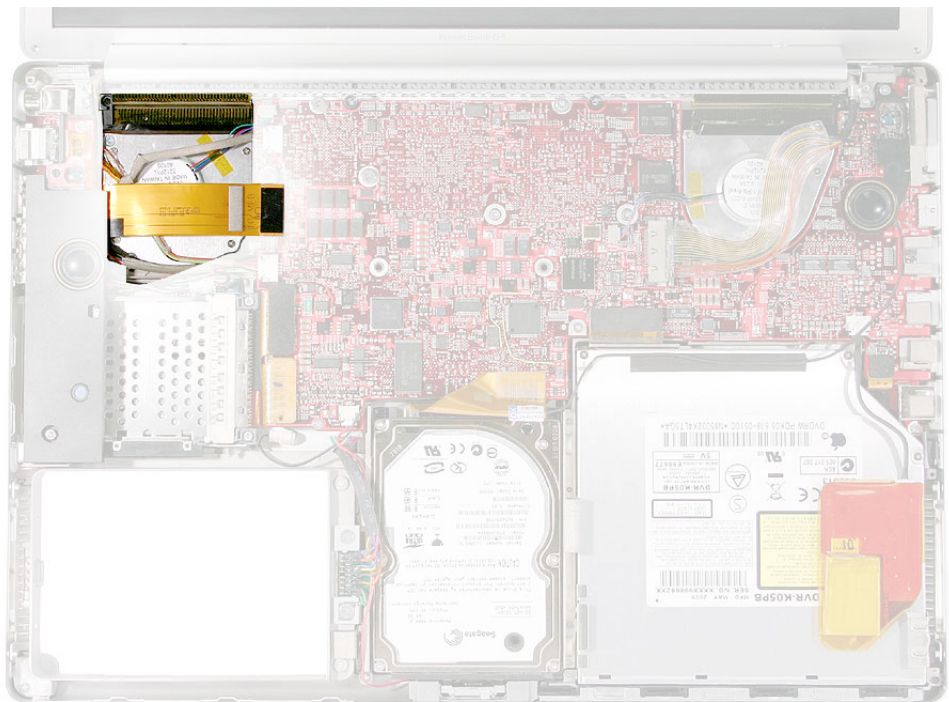

Preliminary Steps

Before you begin, remove the following:

- Battery
- Top case

Note: Replacing the right blower requires removing the logic board.

Procedure

1. Disconnect the four cables shown below.

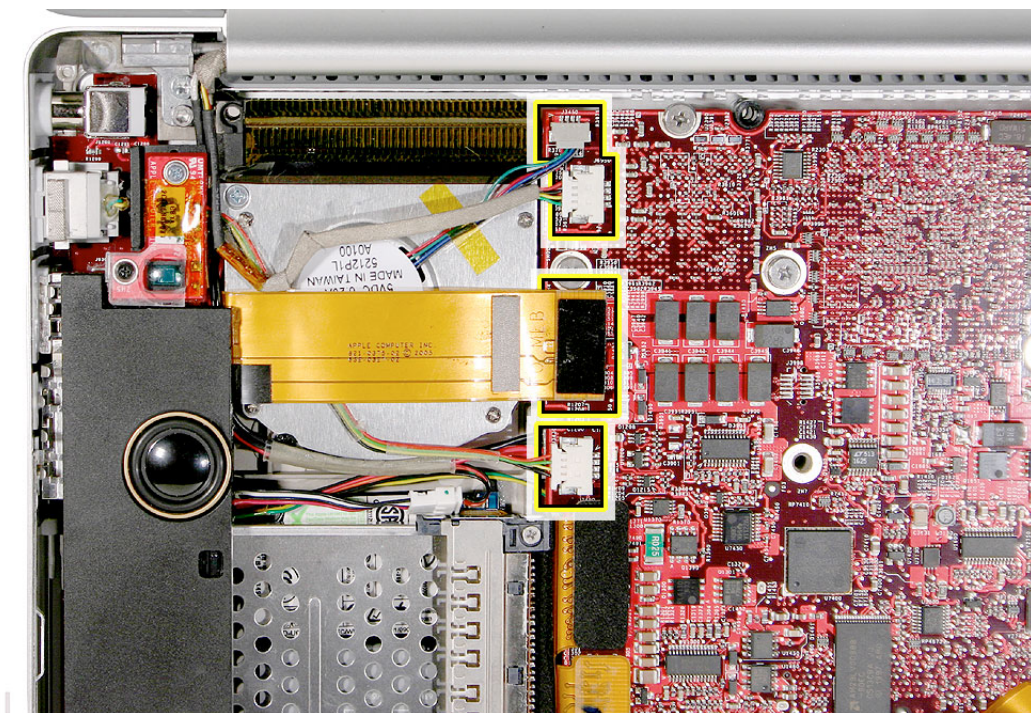

2. Remove four screws.

922-6093



4.5 mm

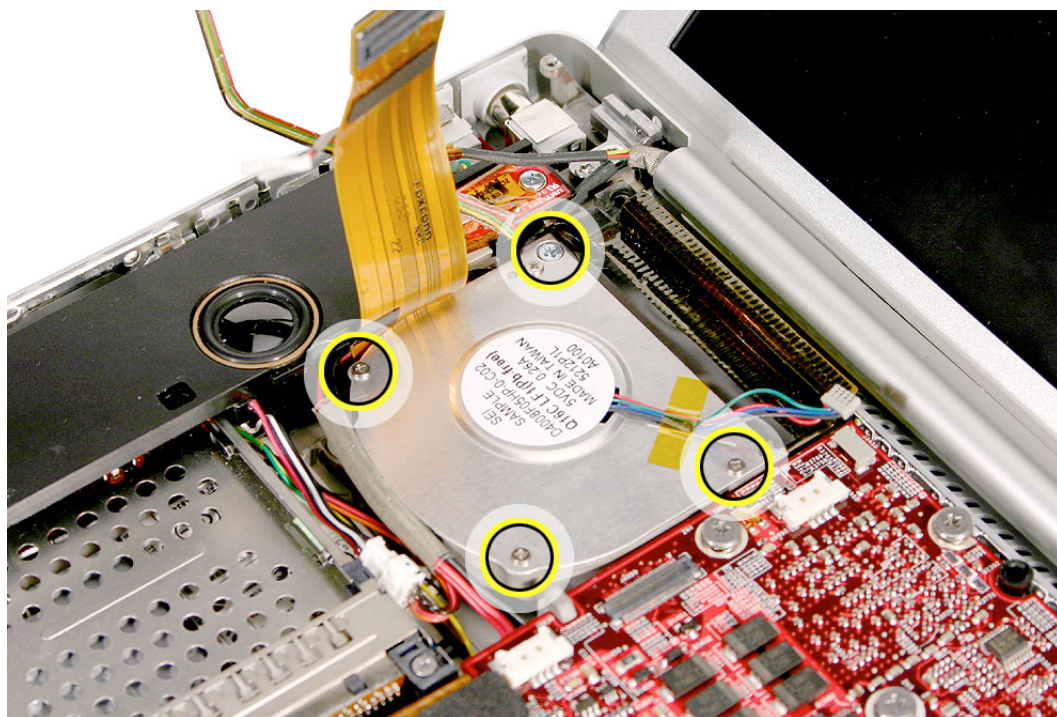

3. Carefully separate any tape used to seal the back edge as you lift out the blower.
4. Install replacement blower. Use Kapton tape to seal as necessary.
5. Use Kapton tape to ensure that the cables lay flat, and that wires will not move into the PC card cage.
6. Reassemble and test computer.

Replacement Note: Ensure that Kapton tape is installed over the fins of the blower.

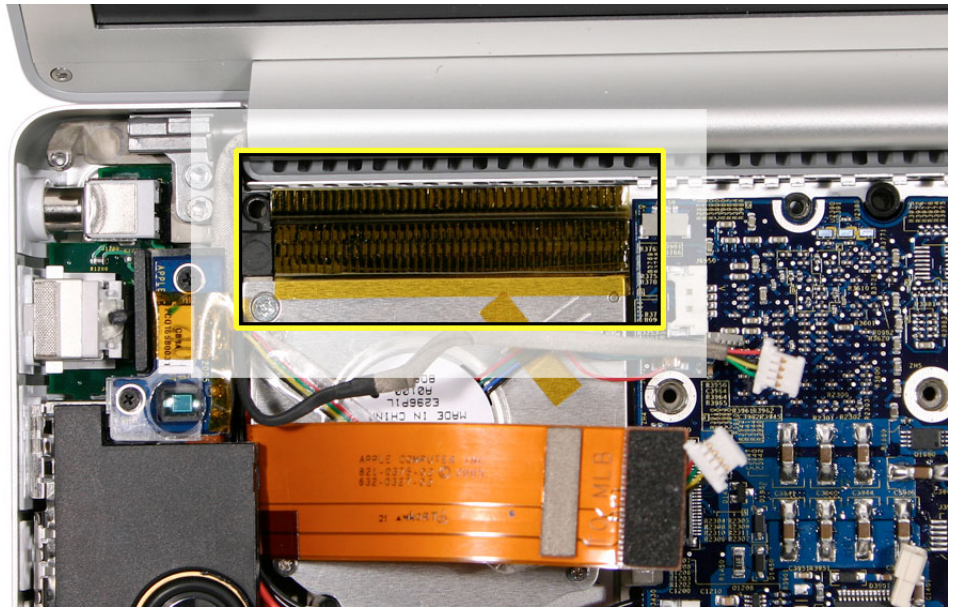



Optical Drive

Tools

This procedure requires the following tools:

- #0 Phillips screwdriver (magnetized)
- Thin double-back tape (if the backup battery will not re-stick securely)
- Black stick (or other nonconductive nylon or plastic flat-blade tool)

Part Location

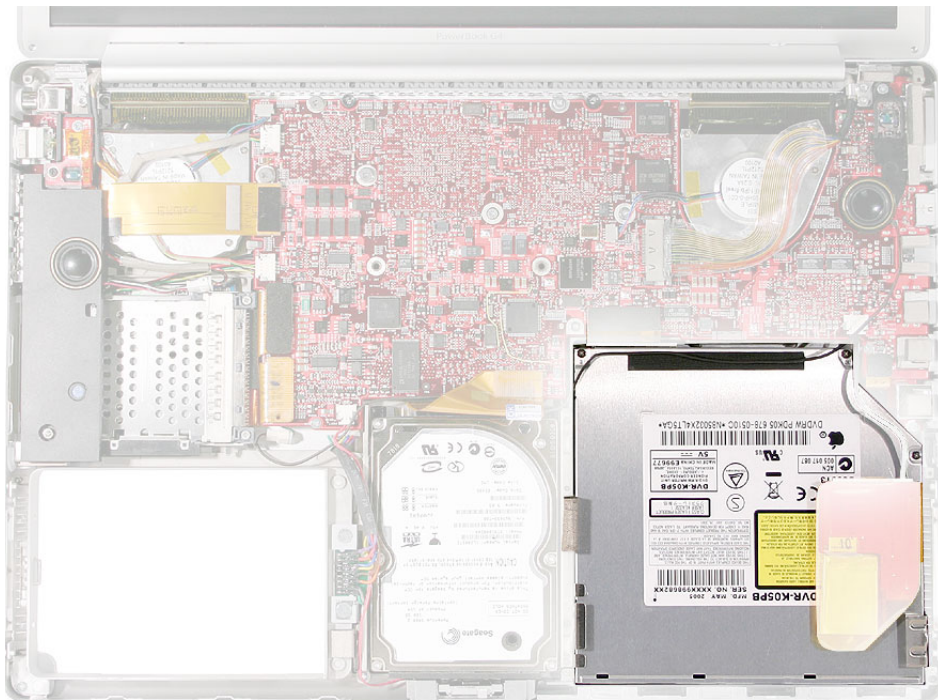

Preliminary Steps

Before you begin, remove the following:

- Battery
- Top case
- Backup battery

Procedure

1. Remove the three screws from the drive holder.

922-6097



6.4 mm

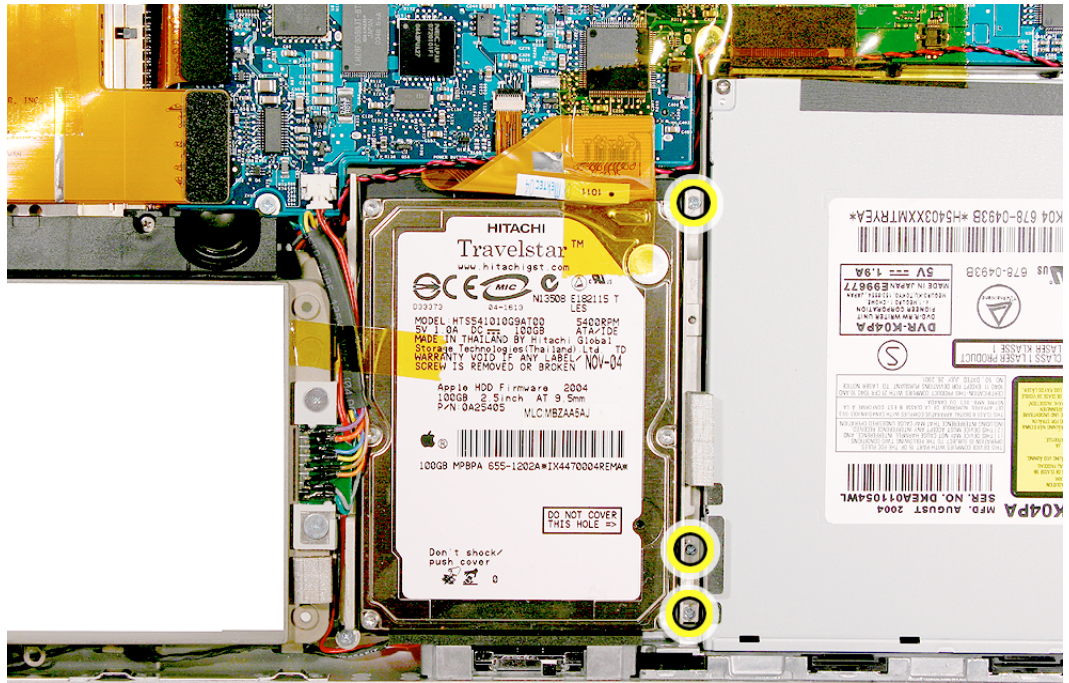

2. Lift out the bracket.

Replacement Note: Verify that the EMI gasket is securely in place.

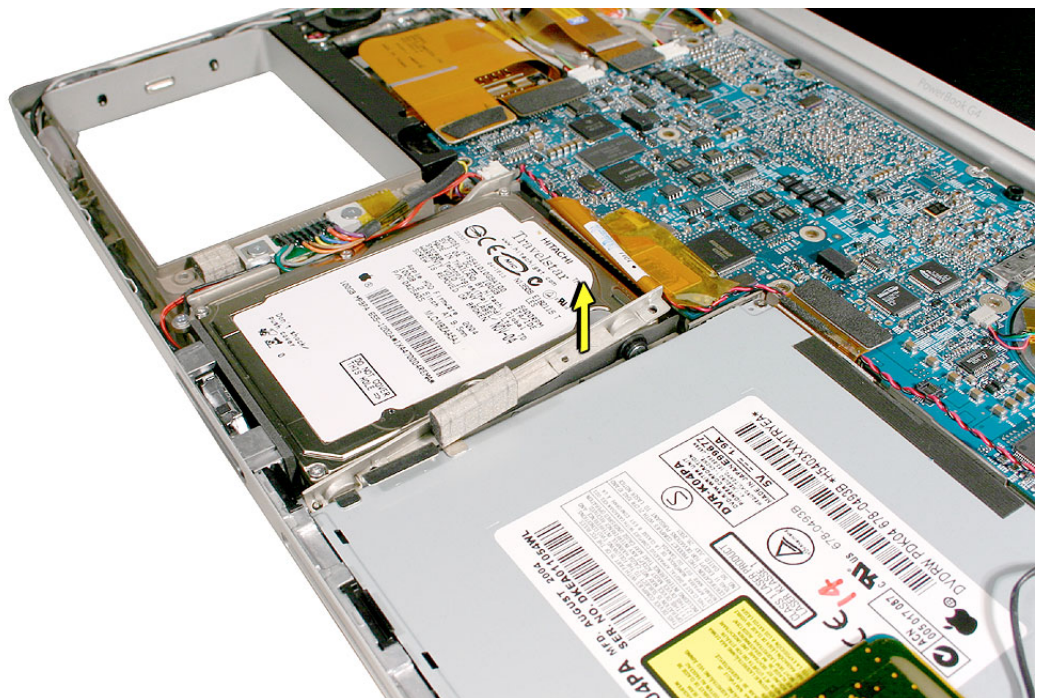

3. Use a black stick to carefully disconnect the optical drive flex cable connector.
4. Remove the screw, shown.

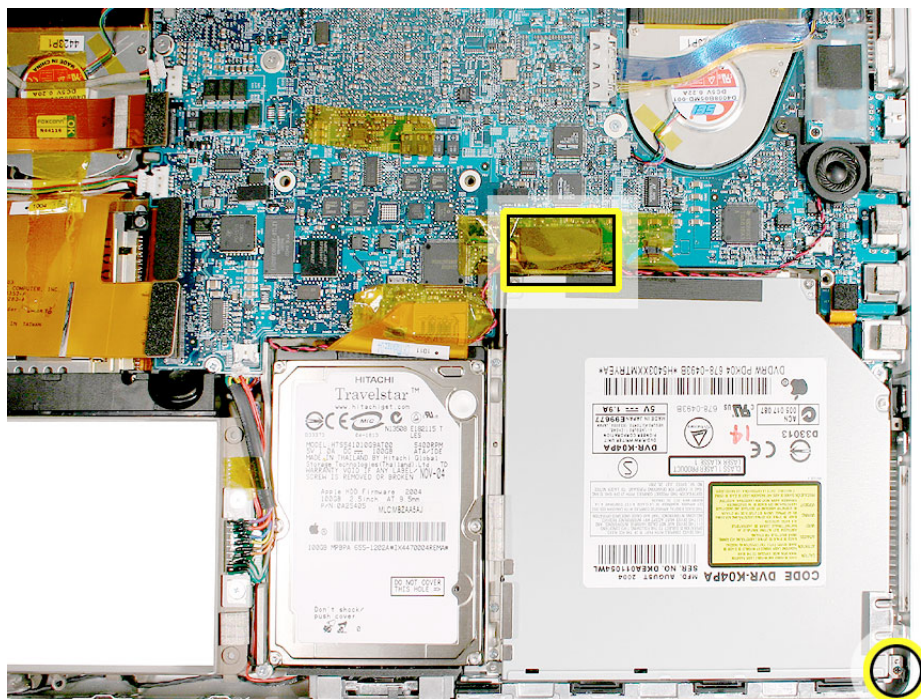

5. Lift up at the rear of the drive and remove.

Warning: Hold the optical drive at its side edges. Do not put pressure in the middle.



6. Transfer the flex cable, side brackets and screws to the replacement optical drive.

922-6488



2.15 mm

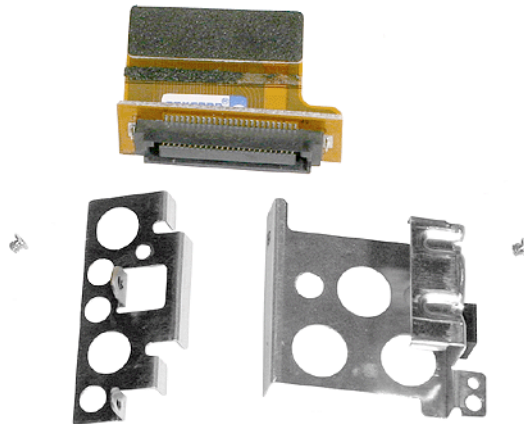

7. Transfer the cosmetic cover to the replacement optical drive.



8. To install the replacement optical drive, insert the front of the drive and ensure that the holes in the front brackets fit over the pins on the internal frame, while lowering the back of the drive into place.

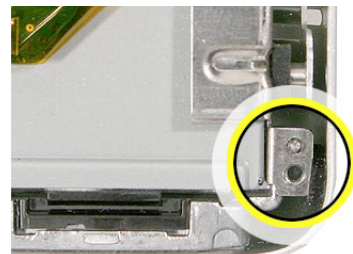
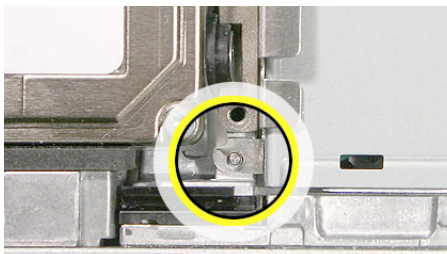

9. Verify that both sides of the drive are fully seated, and reinstall the screw.
10. Connect the optical drive flex cable connector to the logic board.
11. Reassemble the computer.
12. Testing the computer should include powering on, inserting an optical disc and ejecting it to make sure the drive is aligned with the opening and functioning properly.

Test the backup battery by plugging in the power adapter and letting the backup battery charge for half an hour. Then power on the computer and disconnect the power adapter, set the system clock, put the computer to sleep, remove the main battery for five seconds and reinstall. The date and time should not reset.

How to remove a stuck disc from an MKE optical drive

Important: These procedures apply to MKE optical drives, only.

1. Remove the four identical screws that hold the top cover to the drive.



2. Slide the top cover approximately 2 mm toward the back of the drive. Lift up the top cover to remove it.



3. Check the placement of the disc. It is either clamped to the turntable at the center of the disc, or it is wedged under one or more posts at the outer edge of the disc.
4. Holding the edge of the disc, press on the center clamp or hold the posts steady as you remove the disc from the drive.

Important: Do not touch any key components located near the disc.

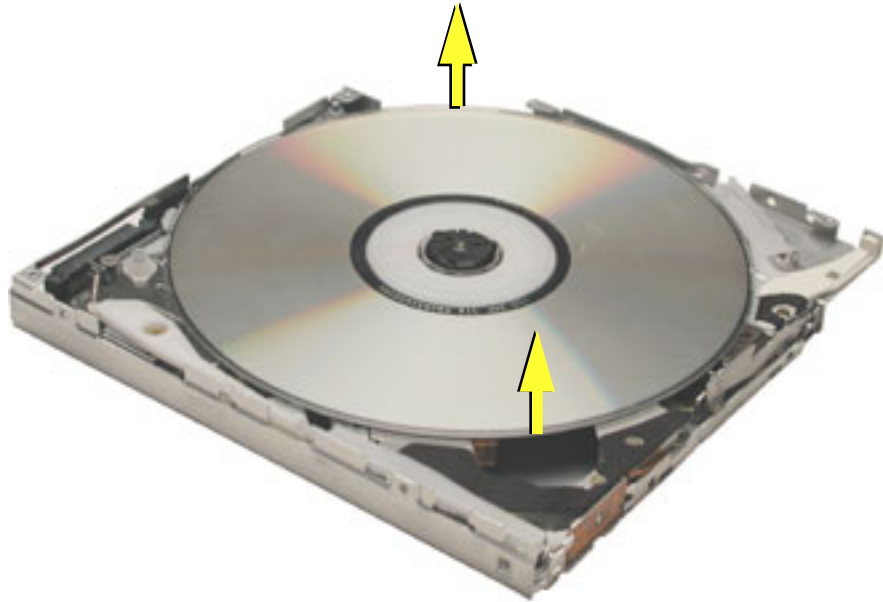

5. Replace the top cover on the drive so that the small hooks on the top cover fit into the slots on the bottom cover. Then slide the top cover into place.



6. Replace the four screws.
7. Install the replacement drive, and reassemble and test the computer.



Hard Drive

Tools

This procedure requires the following tools:

- #0 Phillips screwdriver (magnetized)
- Black stick (or other nonconductive nylon or plastic flat-blade tool)

Part Location

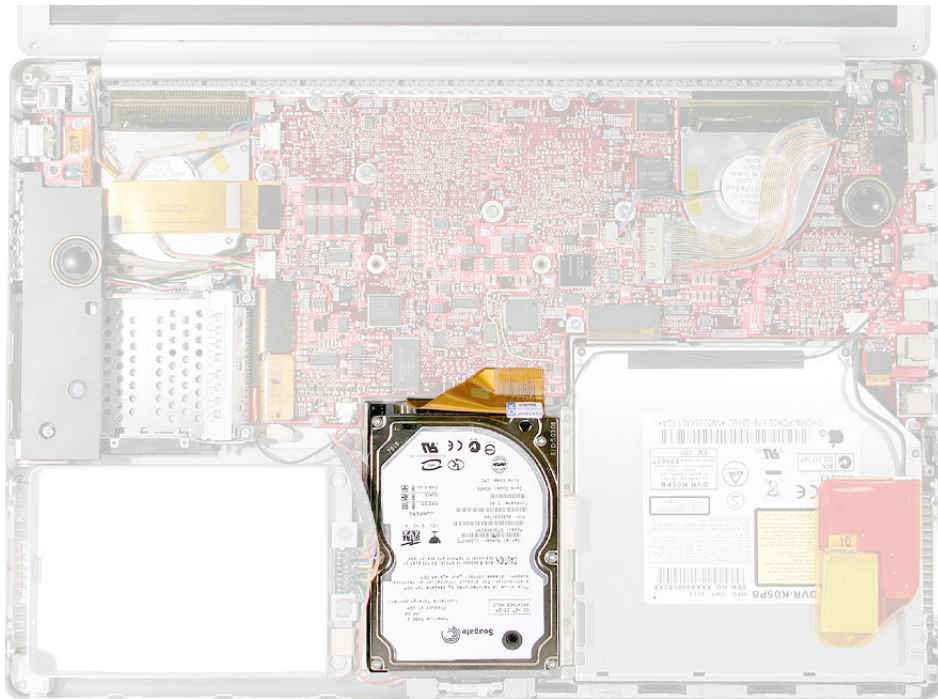

Preliminary Steps

Before you begin, remove the following:

- Battery
- Top case

Procedure

1. Remove the three screws from the drive holder.

922-6097



6.4 mm

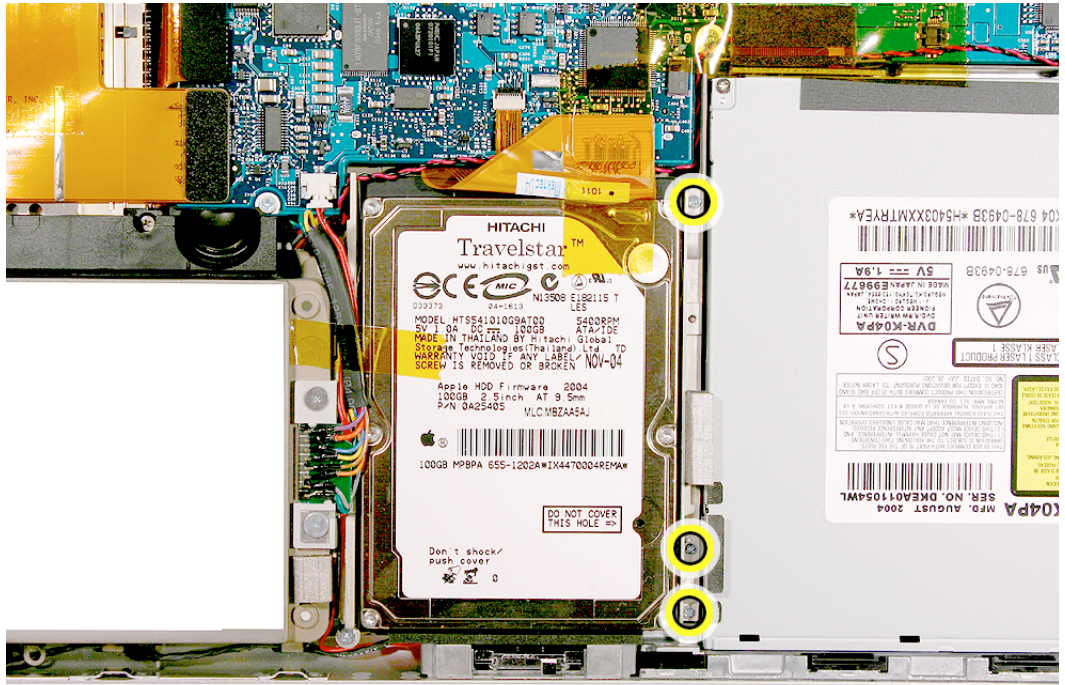

2. Lift out the bracket.

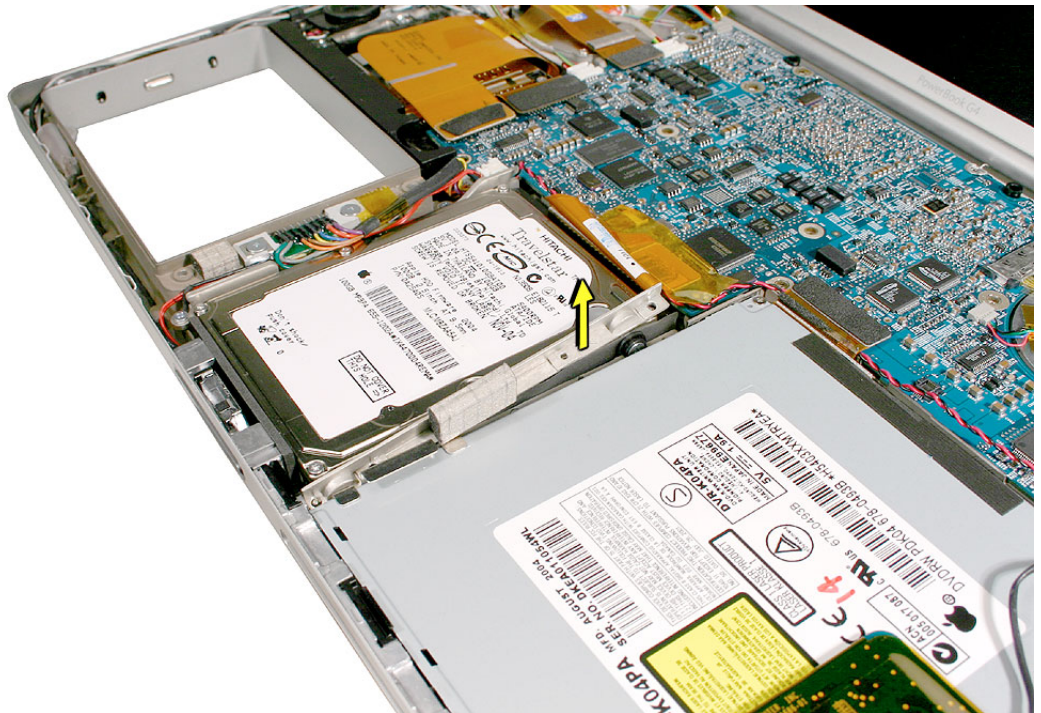

3. Use a black stick to carefully disconnect the hard drive flex cable connector.

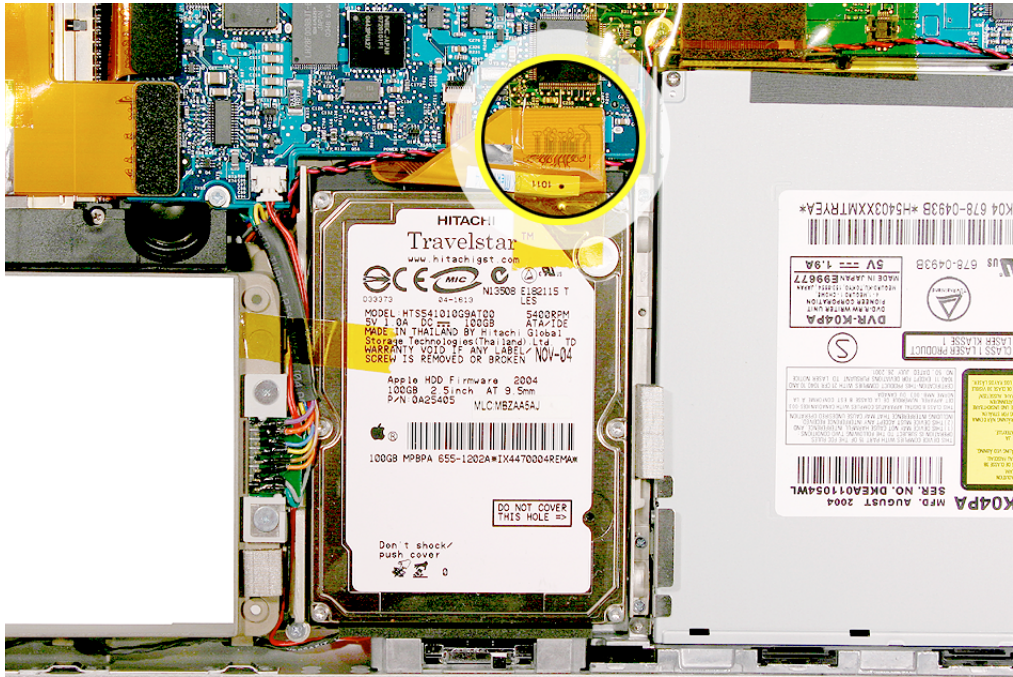

4. Lift up on the right side of the hard drive to remove.

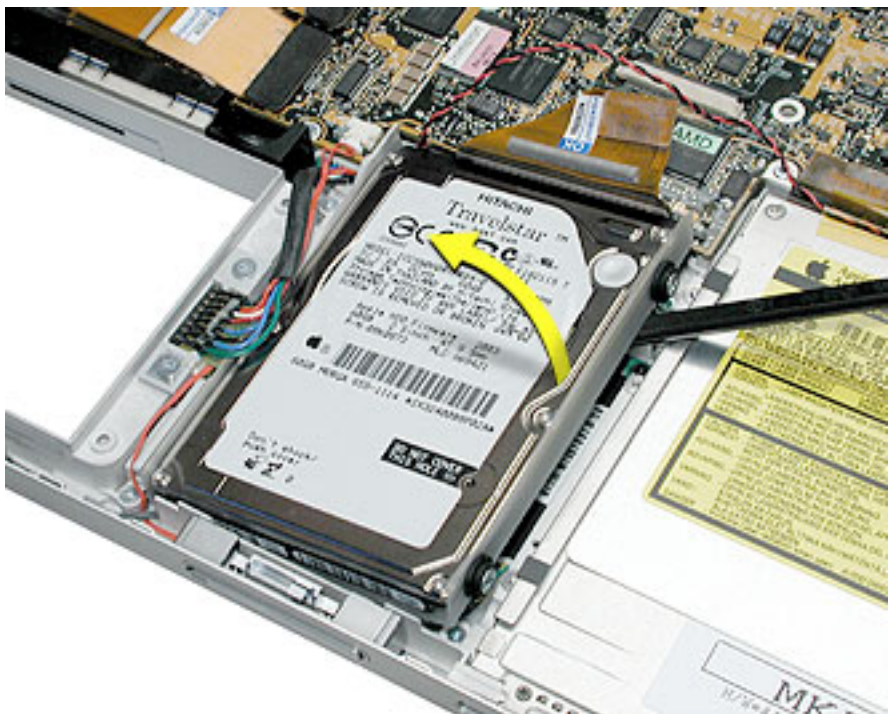

5. Transfer the shield, side screws, rubber shockpads and the flex cable to the replacement hard drive.

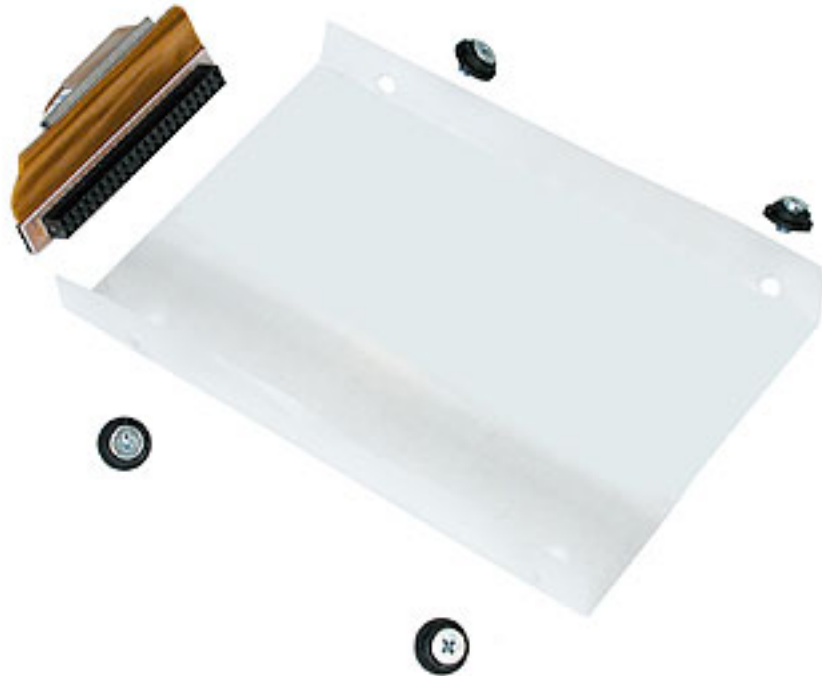

6. Install the replacement hard drive and reassemble the computer.
7. When installing the replacement drive... to avoid exposing the hard drive flex cable contacts, as shown here,...

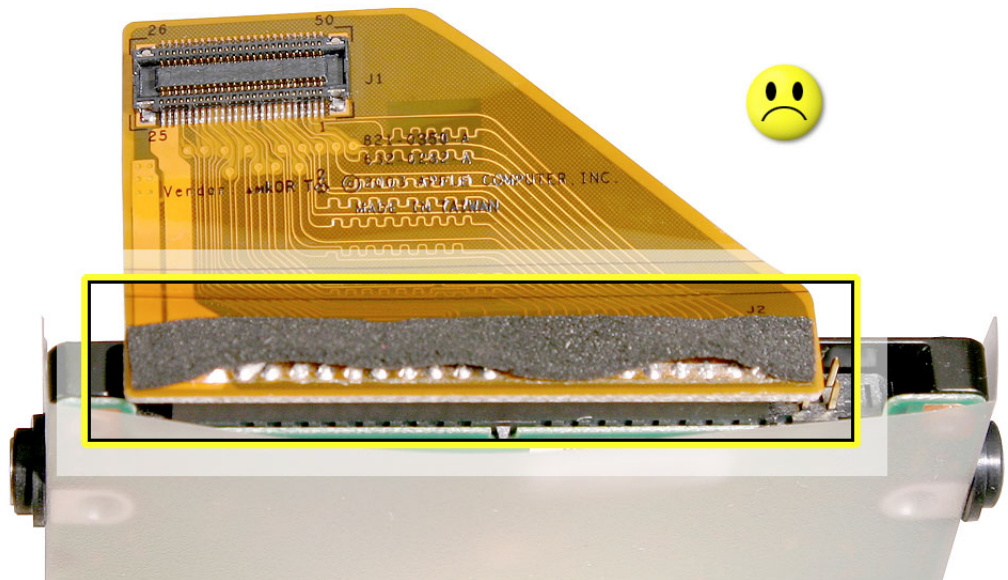

use a black stick to guide the foam (covering the contacts) past the logic board, while...

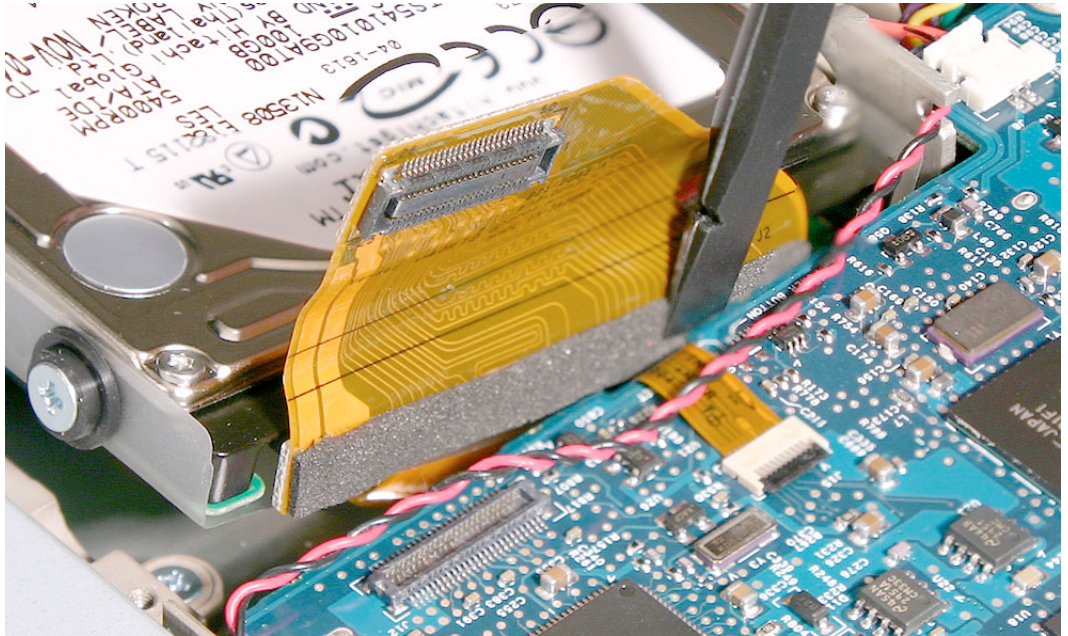

guiding the rubber shockpads securely into the holes in the hard drive holder.

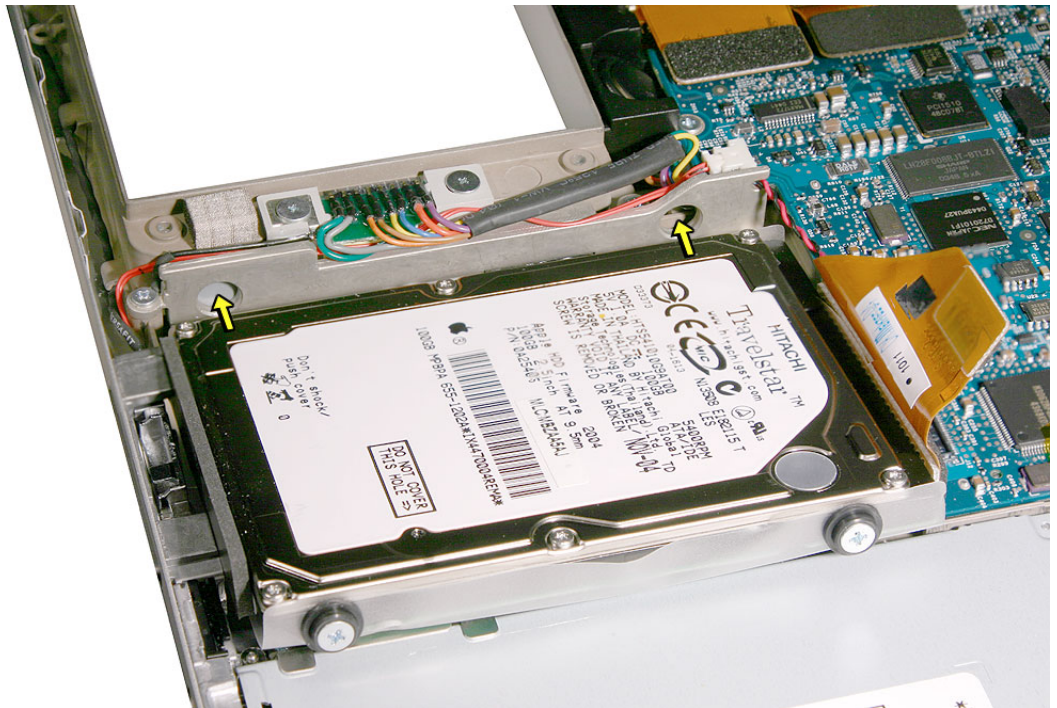

-
8. Make sure all shockpads are seated correctly.
 9. When replacing the hard drive/optical drive holder, make sure that the Mylar shield is not caught.
 10. Testing the computer should include powering on, keyboard and trackpad function, verify that the hard drive is recognized, and that the speakers, and modem works.



Sleep LED

Tools

This procedure requires the following tools:

- #0 Phillips screwdriver (magnetized)
- Black stick (or other nonconductive nylon or plastic flat-blade tool)

Part Location

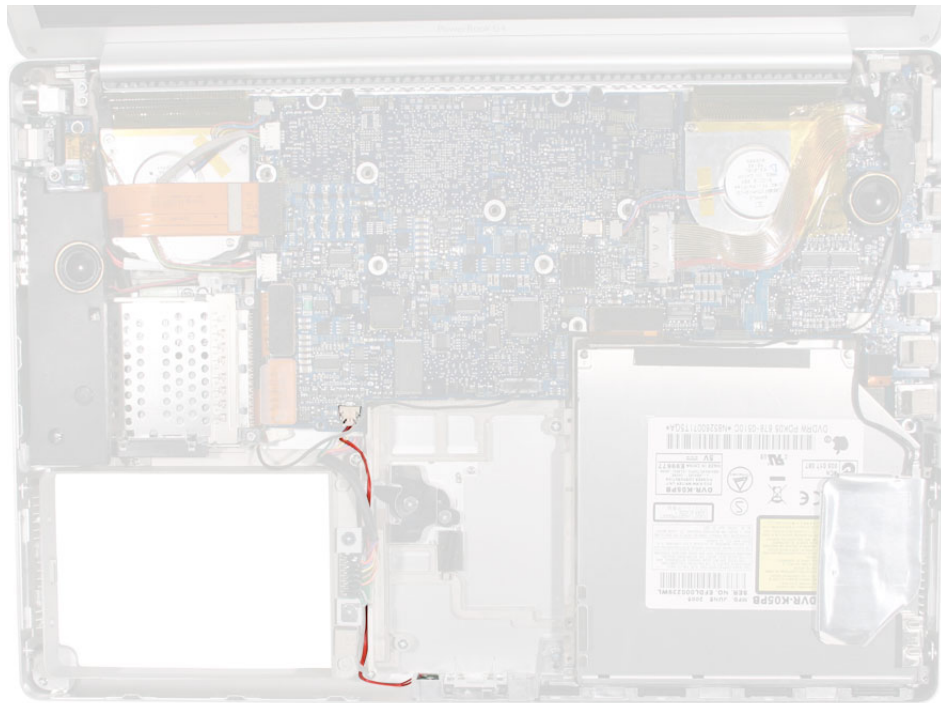

Preliminary Steps

Before you begin, remove the following:

- Battery
- Top case
- Hard drive

Procedure

1. Remove the screw.

922-6093



4.5 mm

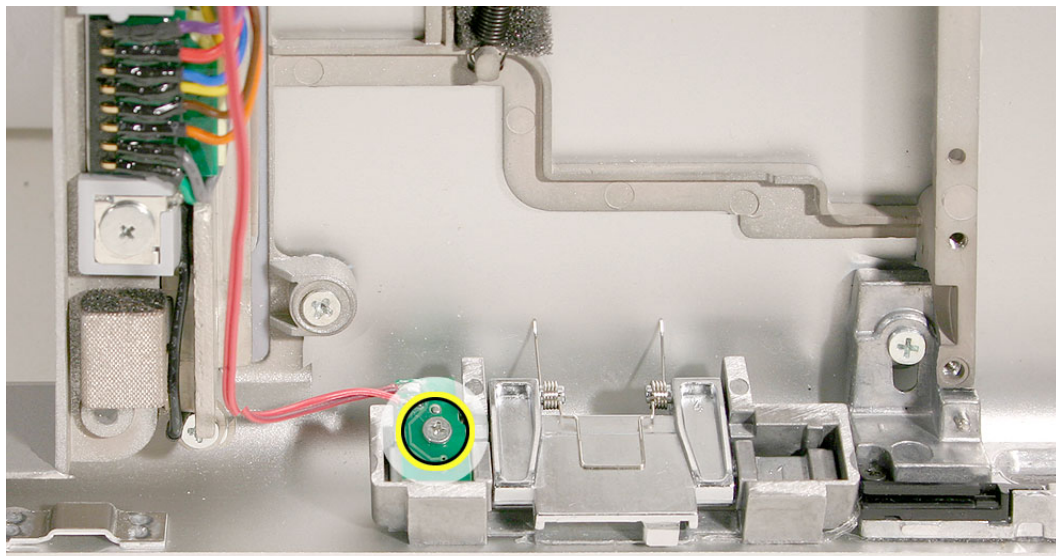

2. Follow the Sleep LED board wire to its connector on the logic board and disconnect it. Lift up any Kapton tape to release the cable, and replace during reinstallation.

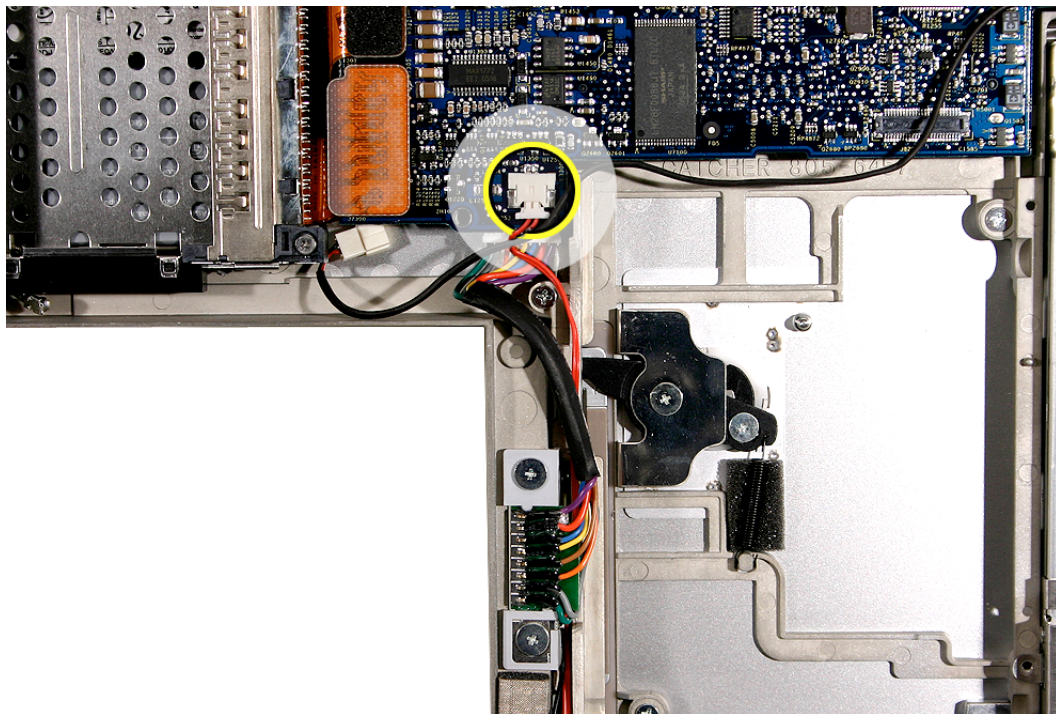

3. Testing the computer should include sleep LED function, hard drive, keyboard and trackpad.



Right Speaker

Tools

This procedure requires the following tools:

- #1 Phillips screwdriver (magnetized)
- Black stick (or other nonconductive nylon or plastic flat-blade tool)

Part Location

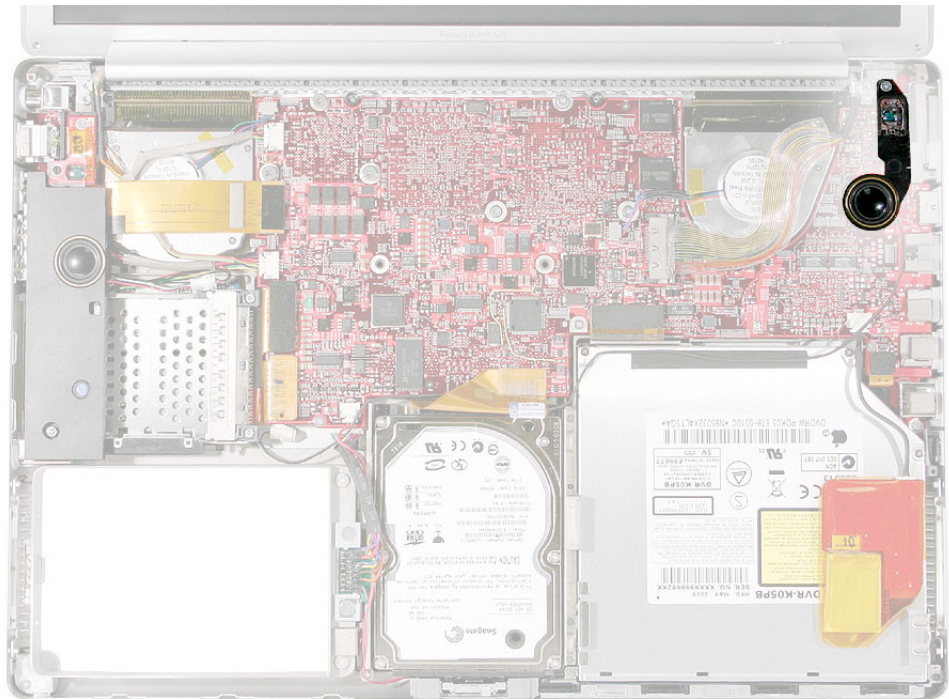

Preliminary Steps

Before you begin, remove the following:

- Battery
- Top case

Procedure

1. Remove one screw.

922-6475



9.5 mm

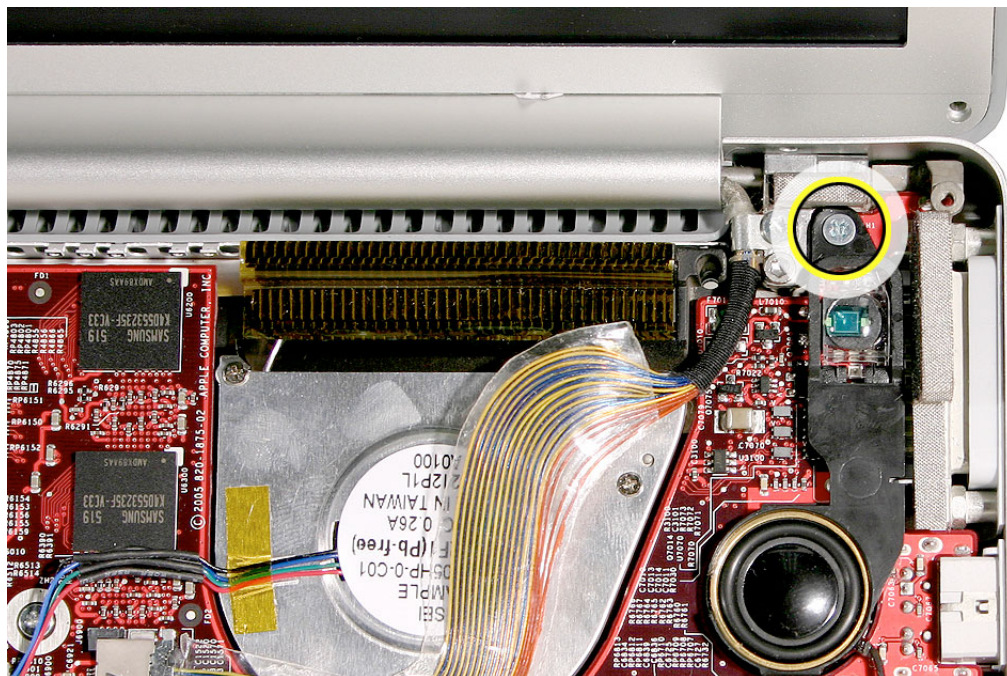

2. Use a black stick to carefully pry out the speaker, as shown.

Note: The right speaker is an assembly that contains the right ambient light sensor lens. Do not disassemble.

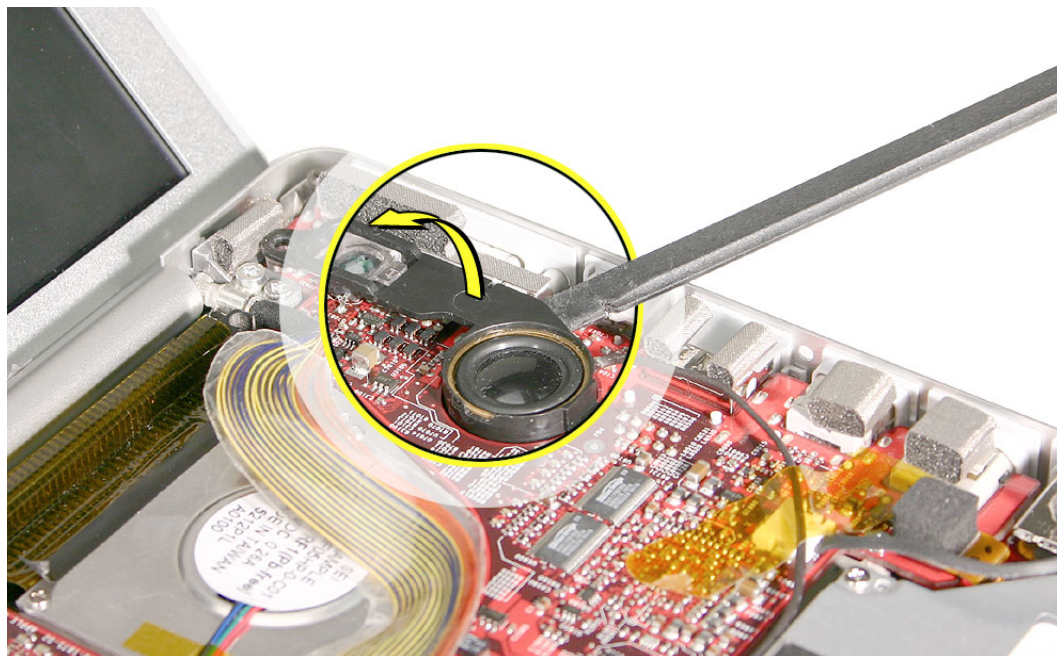

3. Follow the speaker's wire to the main speaker cable connector and disconnect it.

Note: Lift Kapton tape as needed and note the wire routing for reinstallation. Replace Kapton tape when reinstalling.

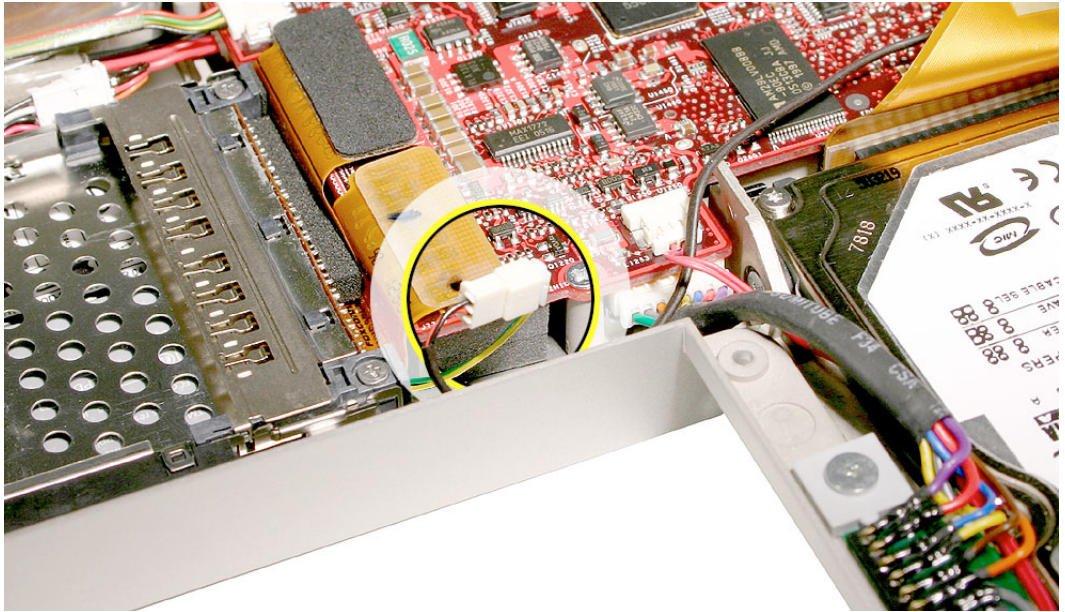

4. To install the right speaker, line up the screw hole in the ALS lens with the hole in the logic board, then press on the hard plastic that surrounds the flexible speaker, to fully seat it into the speaker chamber beneath the logic board.

Important: Do not press on the flexible part of the speaker.

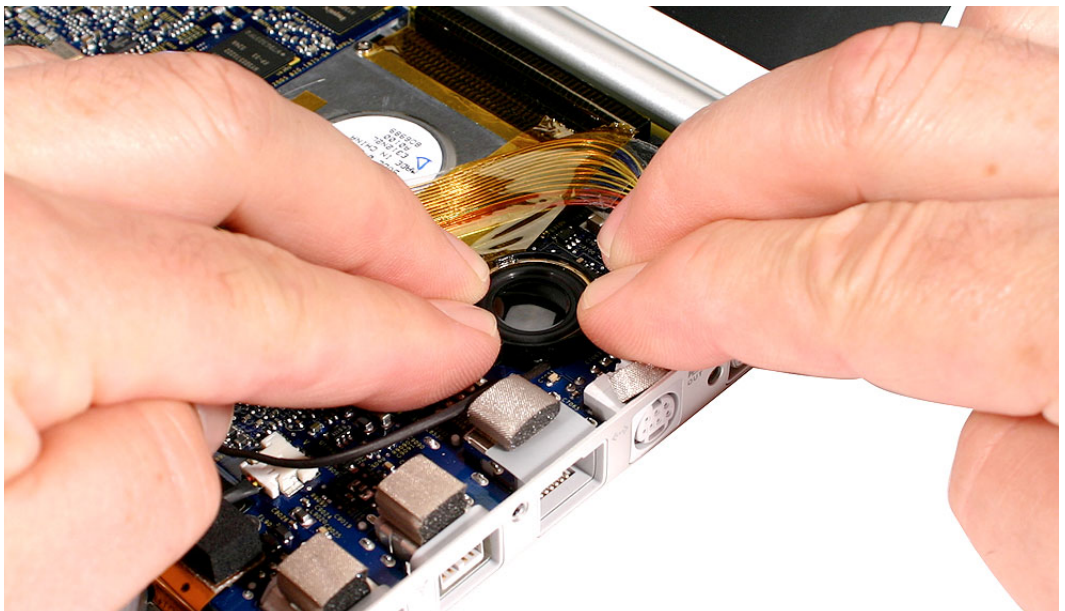

5. Route the speaker cable under flex cables and along the path shown below. Secure in place with Kapton tape as needed.

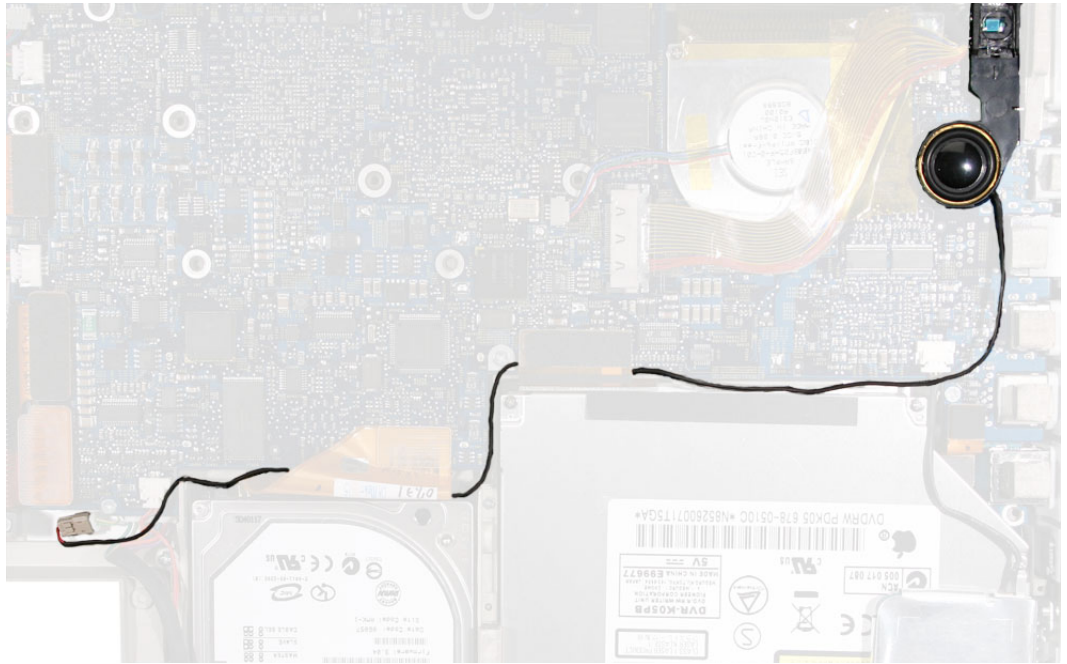

6. Reassemble the computer and test the speakers, including using the Sound system-preference pane.



Left Ambient Light Sensor (ALS)

Important:

- The left ALS cable connects to the logic board in the same connector type and same general location as the inverter cable. Make sure to connect to the correct connector.

Tools

This procedure requires the following tools:

- #0 Phillips screwdriver (magnetized)
- Black stick (or other nonconductive nylon or plastic flat-blade tool)

Part Location

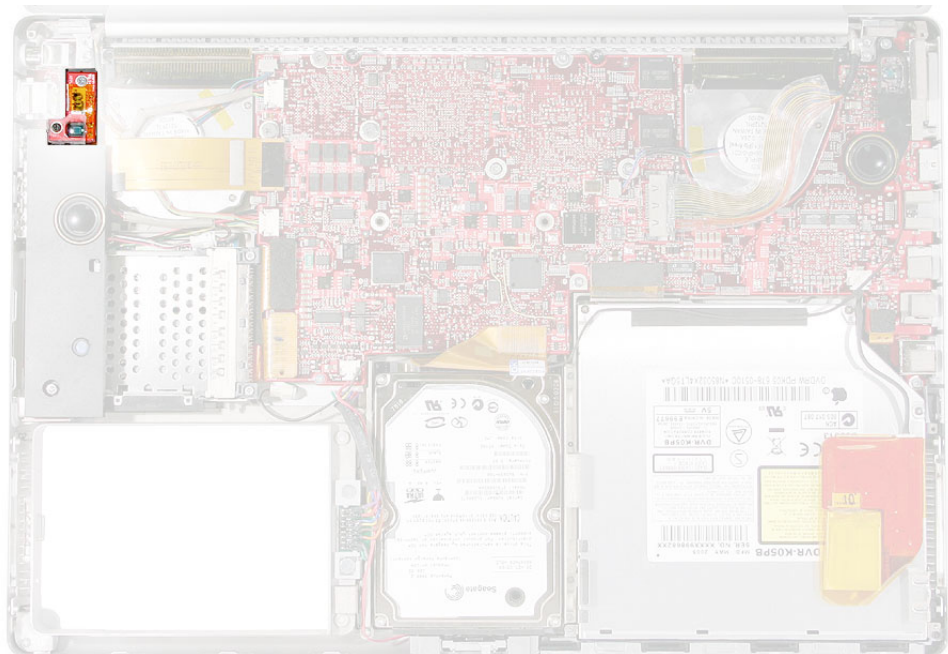

Preliminary Steps

Before you begin, remove the following:

- Battery
- Top case

Procedure

1. Remove the two screws and disconnect the flex cable, shown.

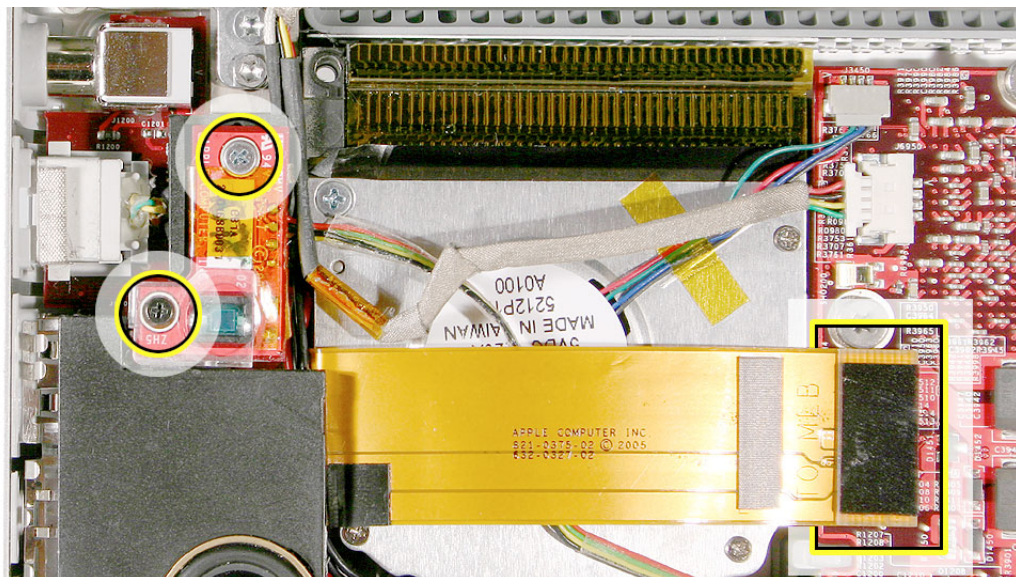

2. Lift the flex cable and disconnect the ALS cable from the logic board.

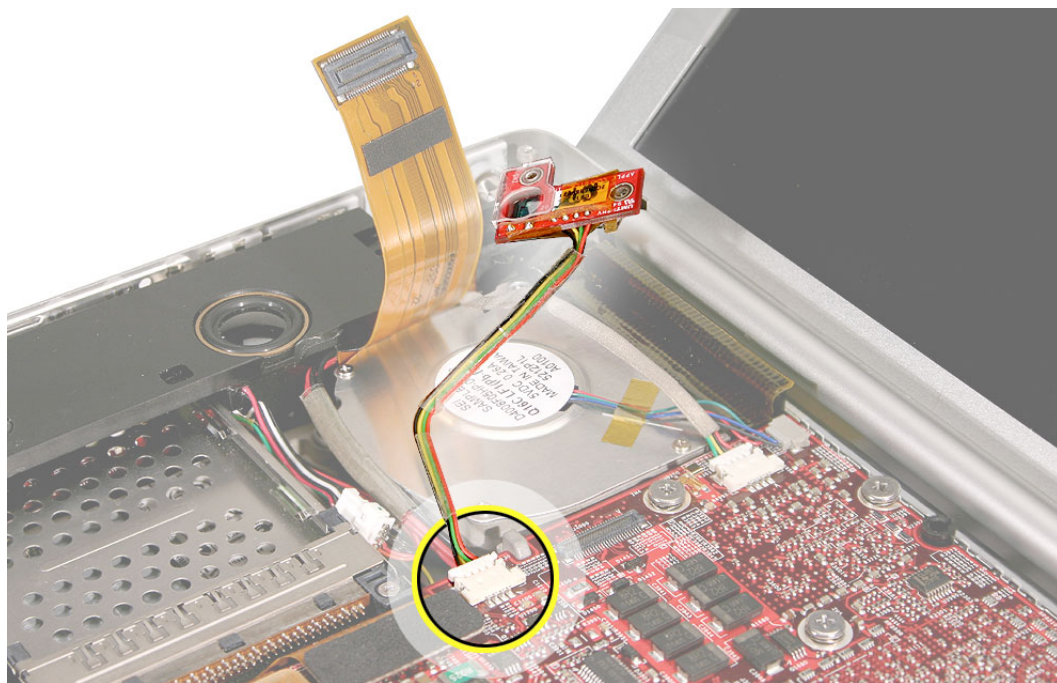

3. **Replacement Note:** Verify that the cable is connected to the correct connector on the logic board, as shown above.
4. Reassemble the computer and test the ambient light sensor operation, trackpad, and keyboard.



Left Speaker

Tools

This procedure requires the following tools:

- 4mm Hex socket wrench
- Black stick (or other nonconductive nylon or plastic flat-blade tool)

Part Location

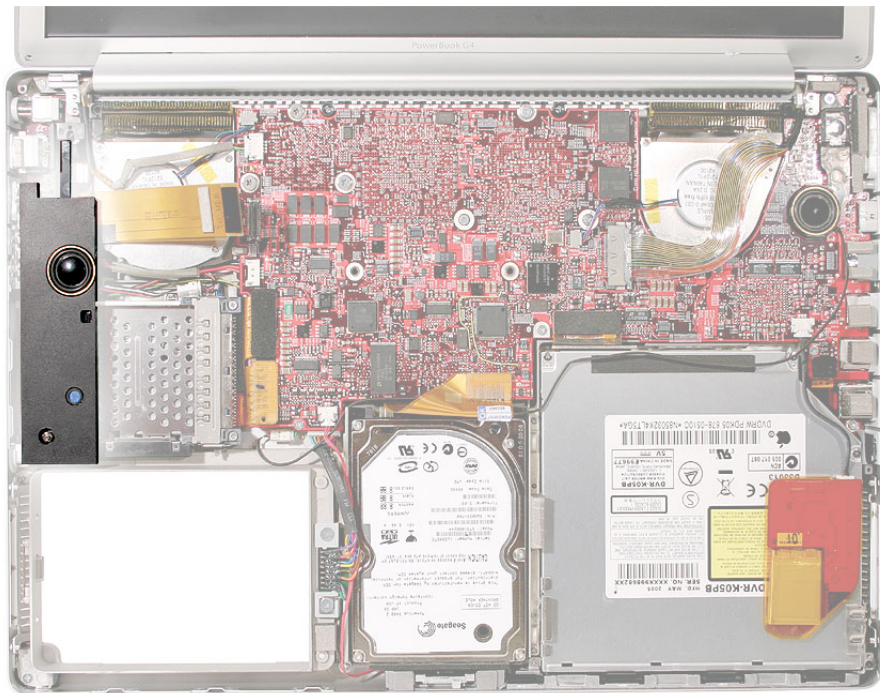

Preliminary Steps

Before you begin, remove the following:

- Battery
- Top case
- Left ambient light sensor



PC Card Cage

Tools

This procedure requires the following tools:

- #0 Phillips screwdriver (magnetized)
- Black stick (or other nonconductive nylon or plastic flat-blade tool)

Part Location

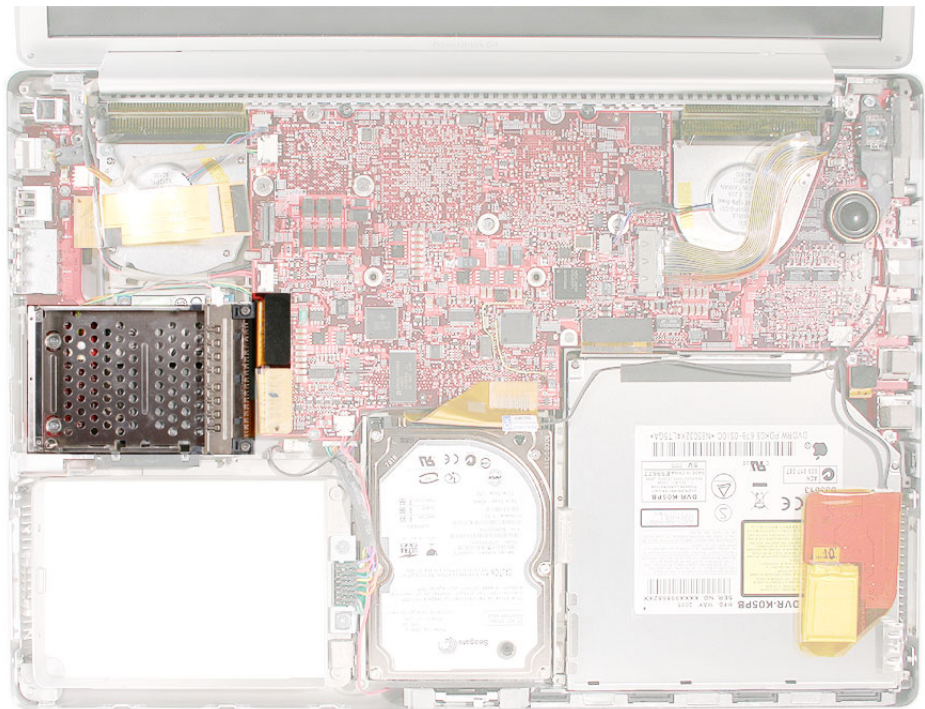

Preliminary Steps

Before you begin, remove the following:

- Battery
- Top case
- Left ambient light sensor board
- Left speaker

Procedure

1. Use a black stick to disconnect the PC card cage flex cable.

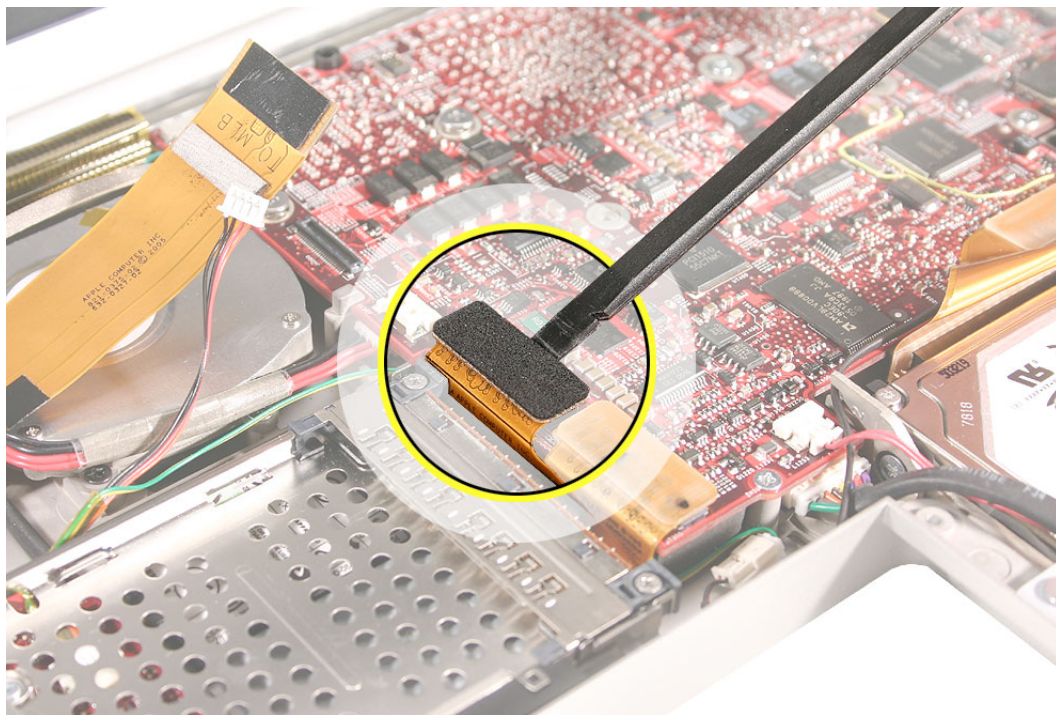

2. Remove the four screws.

922-6093



4.5 mm

922-6470



6.6 mm

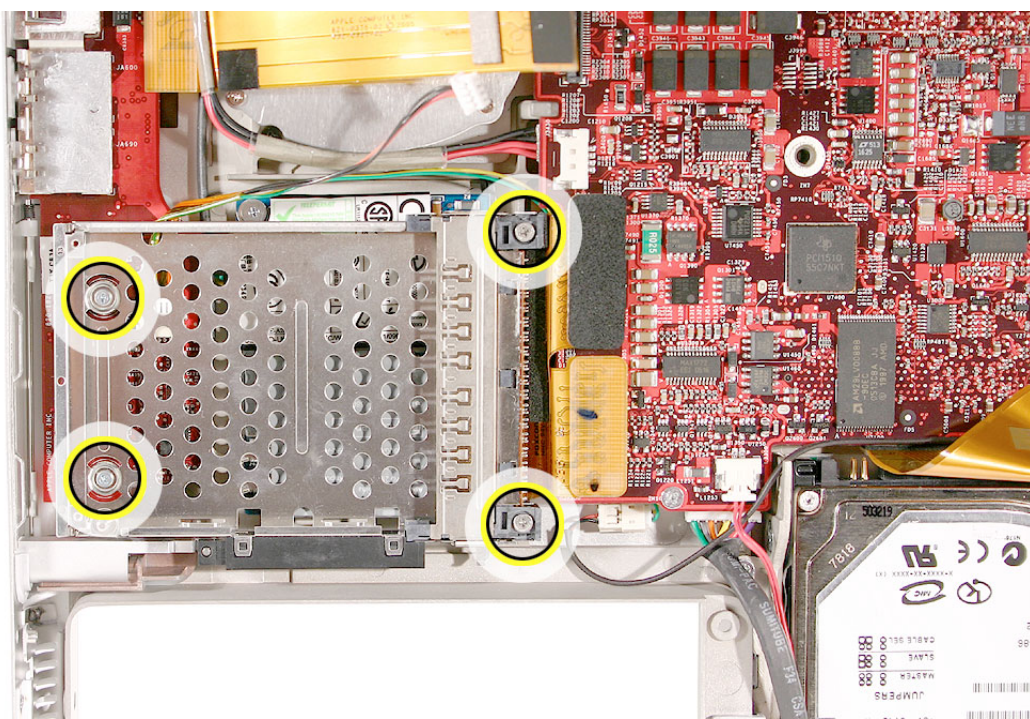

- Carefully lift up the PC card cage to clear the pin on the eject button.

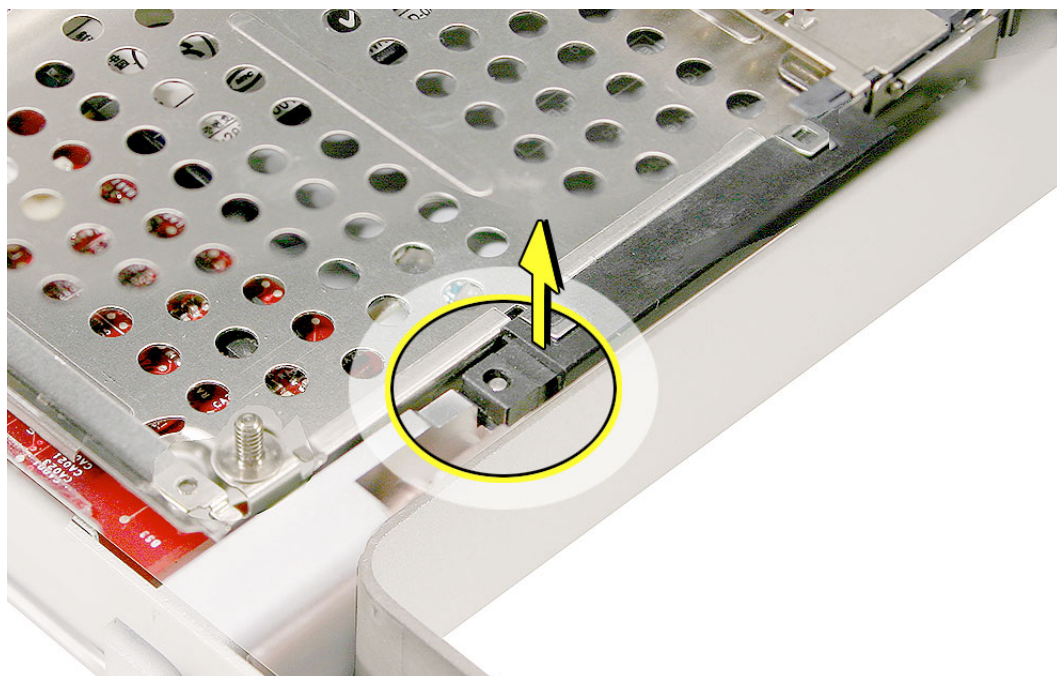

- Insert the replacement PC card cage and eject button.

Replacement Note: Ensure that the pin on the PC card cage eject button is secured by the hole in the cage mechanism, as shown above.

- Align the holes in the cage with the screw bosses on the bottom case.
- Lightly install all four screws before tightening (**note:** longer screws go in the back by the flex cable), then tighten in the following order.

922-6093



4.5 mm

922-6470



6.6 mm

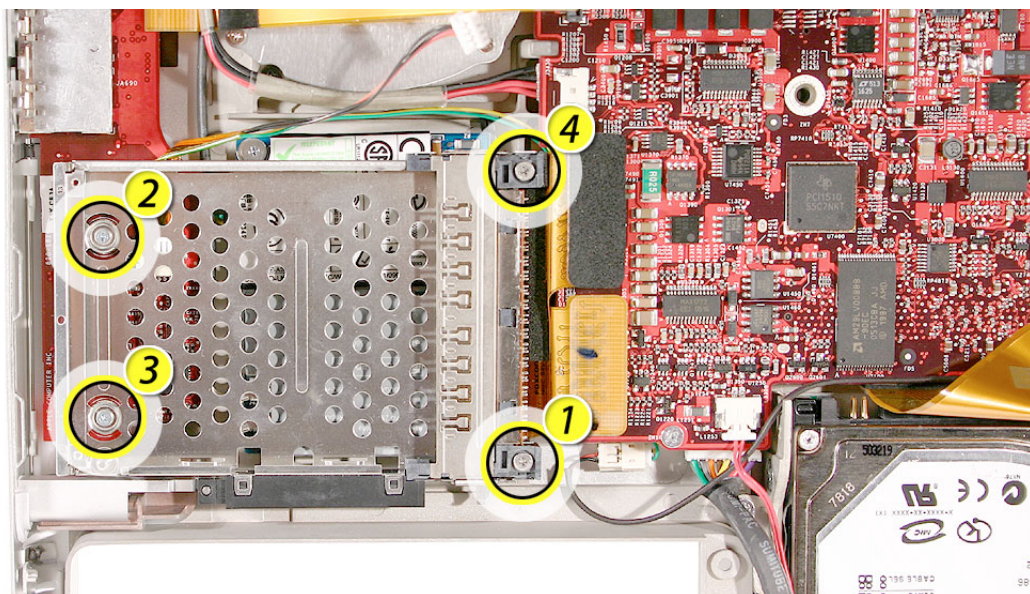

-
7. Reassemble the computer.
 8. Testing should include inserting a PC card to check that it can be locked in and that the eject button works smoothly. Check that the speakers work, and that the trackpad and keyboard function properly. Check that the modem and Bluetooth operate. Operate the computer in a darkened room to check for keyboard backlight function.



AirPort Extreme w/ Bluetooth

Tools

This procedure requires the following tools:

- #0 Phillips screwdriver (magnetized)
- Black stick (or other nonconductive nylon or plastic flat-blade tool)

Part Location

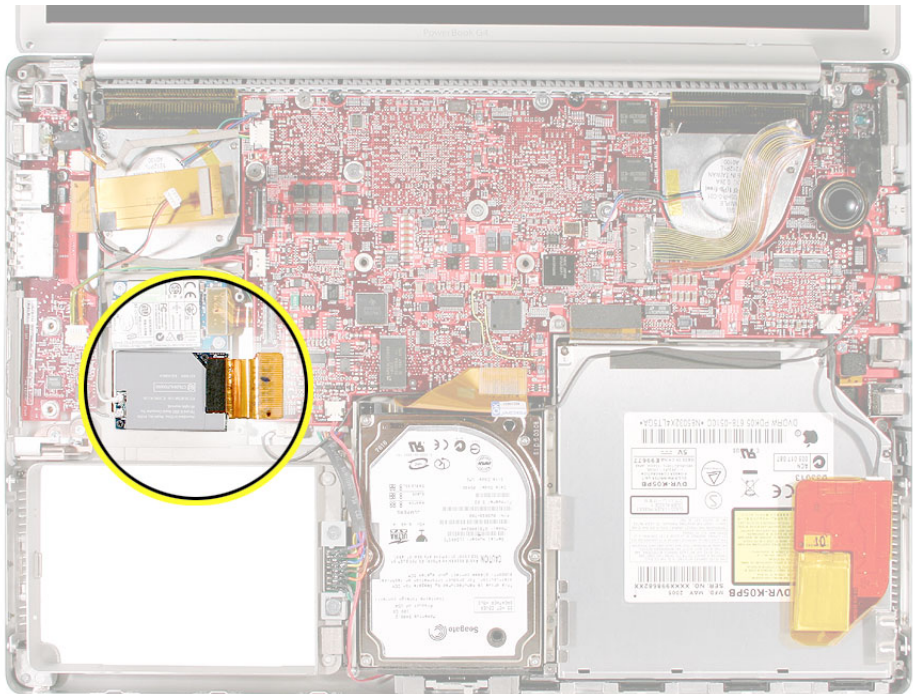

Preliminary Steps

Before you begin, remove the following:

- Battery
- Top case
- PC card cage

Procedure

1. Disconnect the flex cable.
2. Carefully lift off the antenna cables.

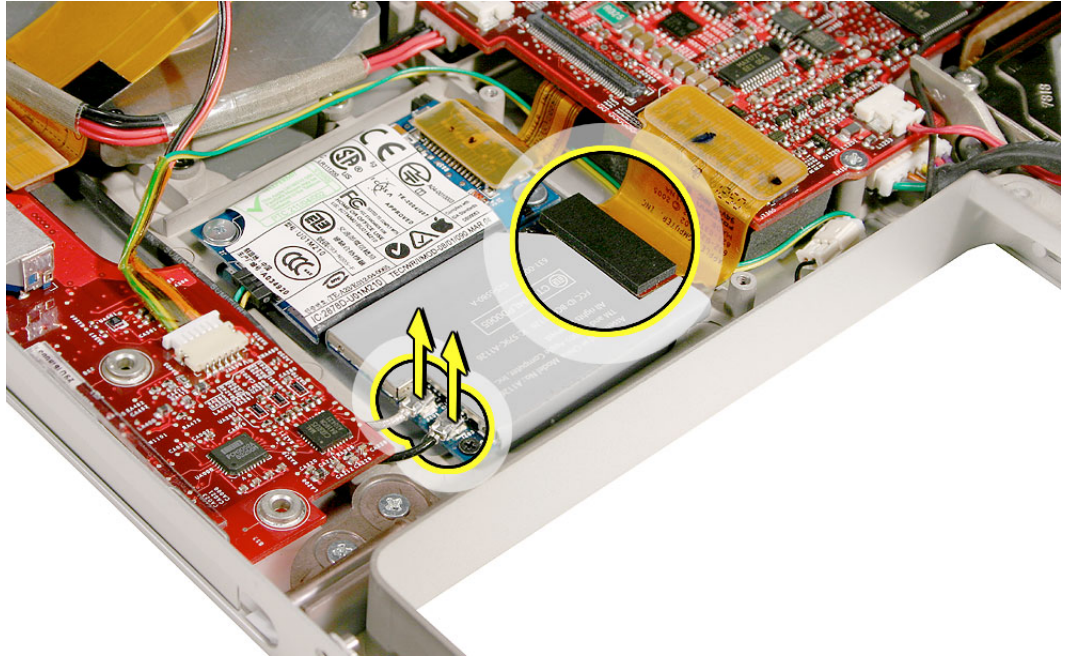

3. Remove the two screws.

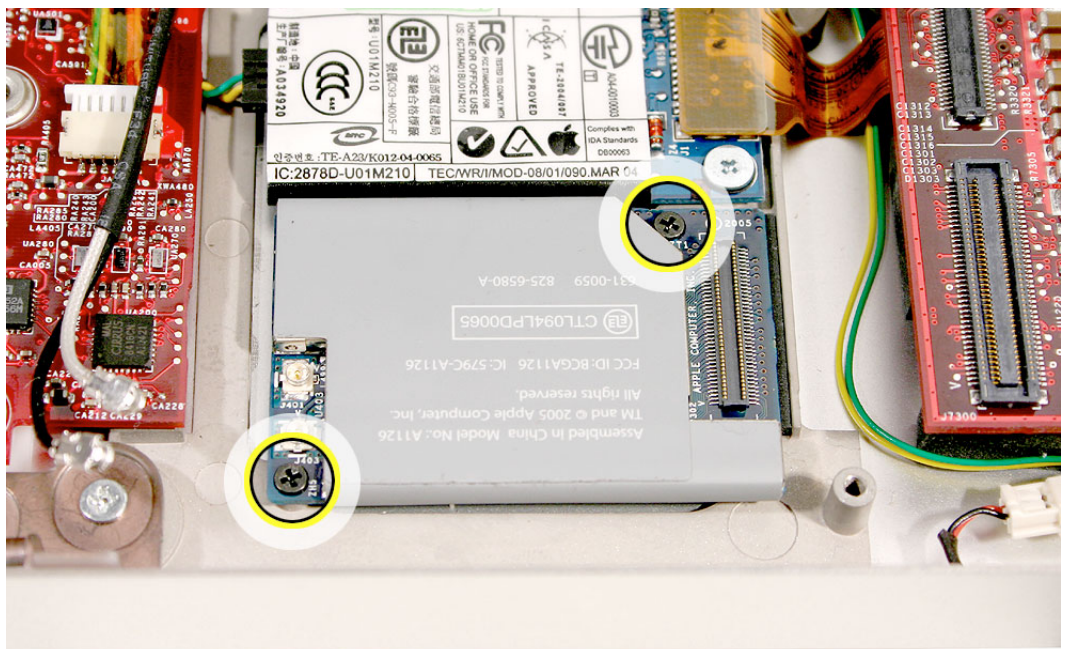

4. Reassemble the computer.

-
5. Testing the computer should include using Apple System Profiler to check that the AirPort Extreme card is recognized, test that the AirPort Extreme card is working, insert a PC card to check that it can be locked in and that the eject button works smoothly. Check that both speakers work, and that the trackpad and keyboard function properly. Check that the modem and Bluetooth operate. Operate the computer in a darkened room to check for keyboard backlight function.



Modem

Important:

- The flex cable routes under the logic board and is secured by adhesive foam. The logic board must be removed to remove or replace the modem flex cable.
- There are two insulator washers, one on each side of the modem, on the modem screw nearest the logic board.
- A grounding strap on the speaker cable must be captured by the modem screw.

Tools

This procedure requires the following tools:

- #0 Phillips screwdriver (magnetized)
- Black stick (or other nonconductive nylon or plastic flat-blade tool)

Part Location

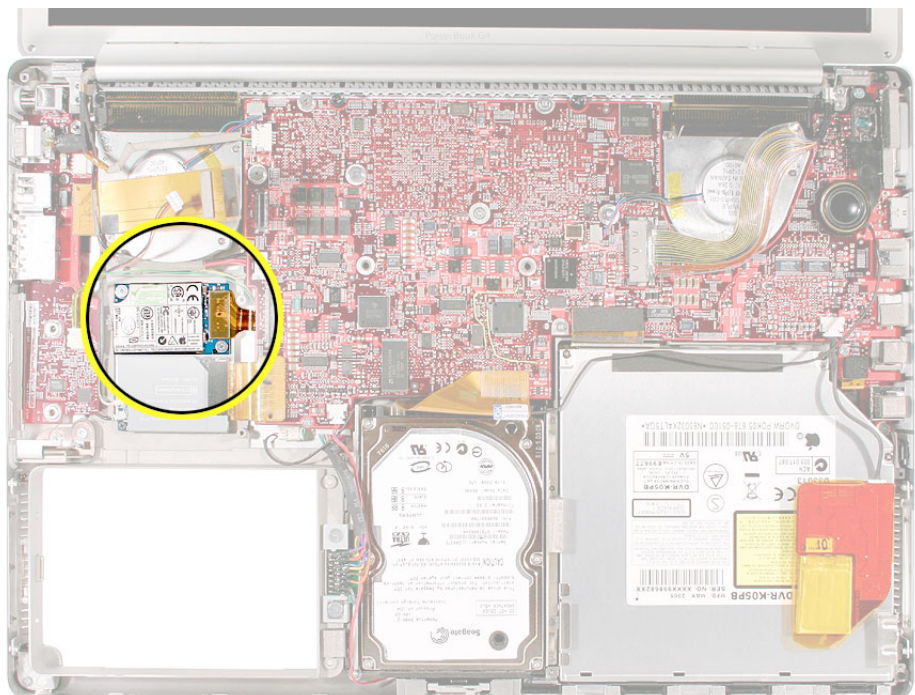

Preliminary Steps

Before you begin, remove the following:

- Battery
- Top case
- PC card cage

Procedure

1. Disconnect the flex. **Important:** Do not attempt to disconnect it from the logic board.

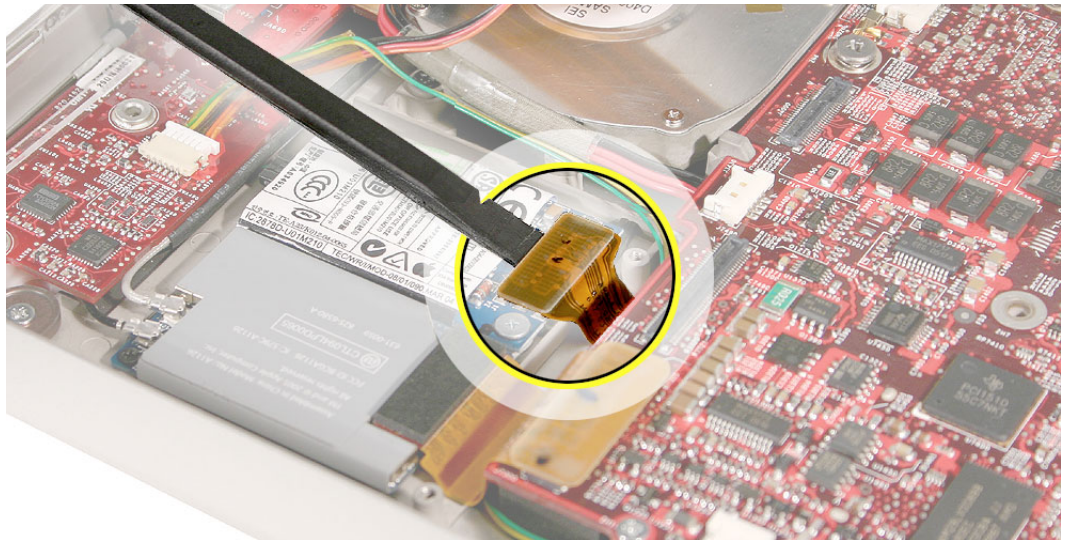

2. Remove the two screws.

Replacement Note: One screw secures a metallic strap attached to the main speaker cable.

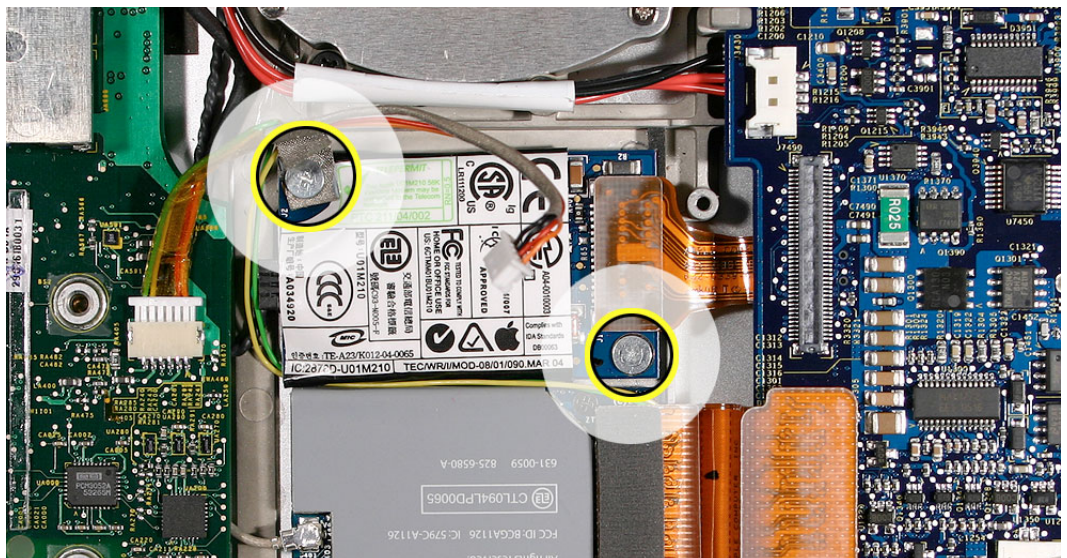

Important: The screw nearest the logic board uses two insulator washers. One on the screw (922-7145) and one on the internal frame under the modem. Make sure that these insulators are in place before reinstalling the modem.

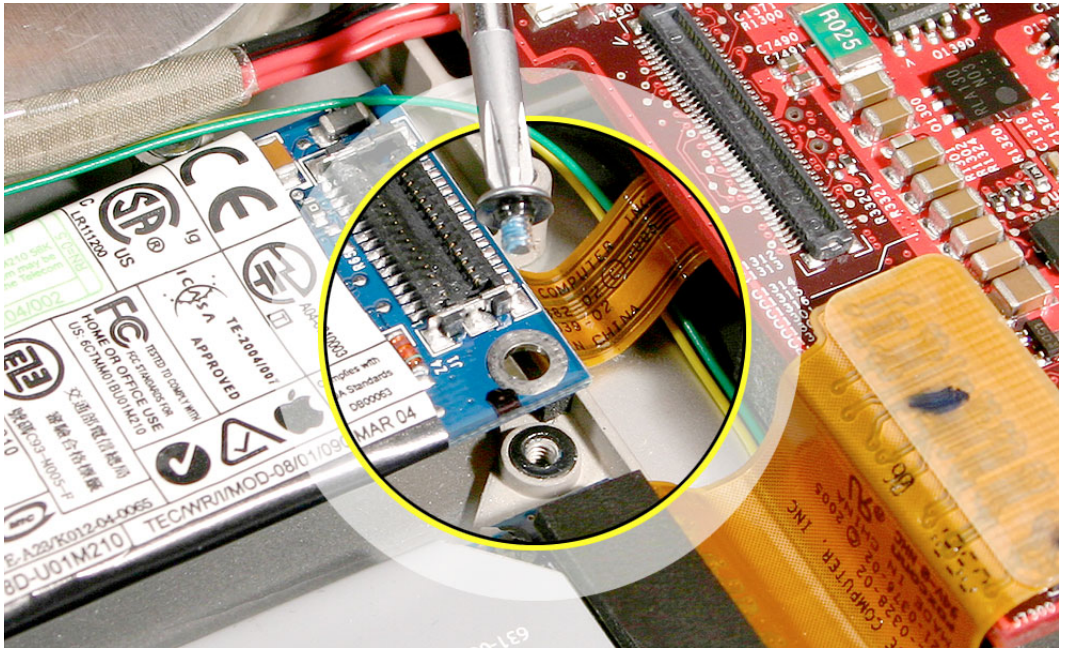

3. Disconnect the modem RJ-11 cable from the end of the modem.

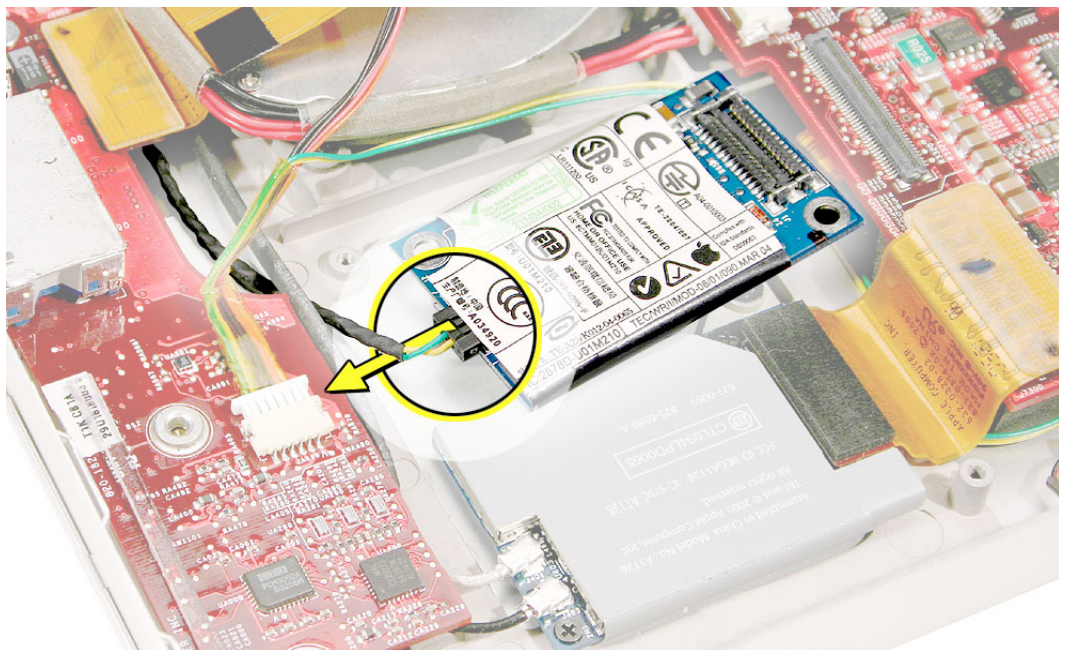

4. Install the modem, reassemble the computer and test the modem.



Sound/DC-In Board

Tools

This procedure requires the following tools:

- #1 Phillips screwdriver (magnetized)
- 5 mm socket wrench
- Black stick (or other nonconductive nylon or plastic flat-blade tool)

Part Location

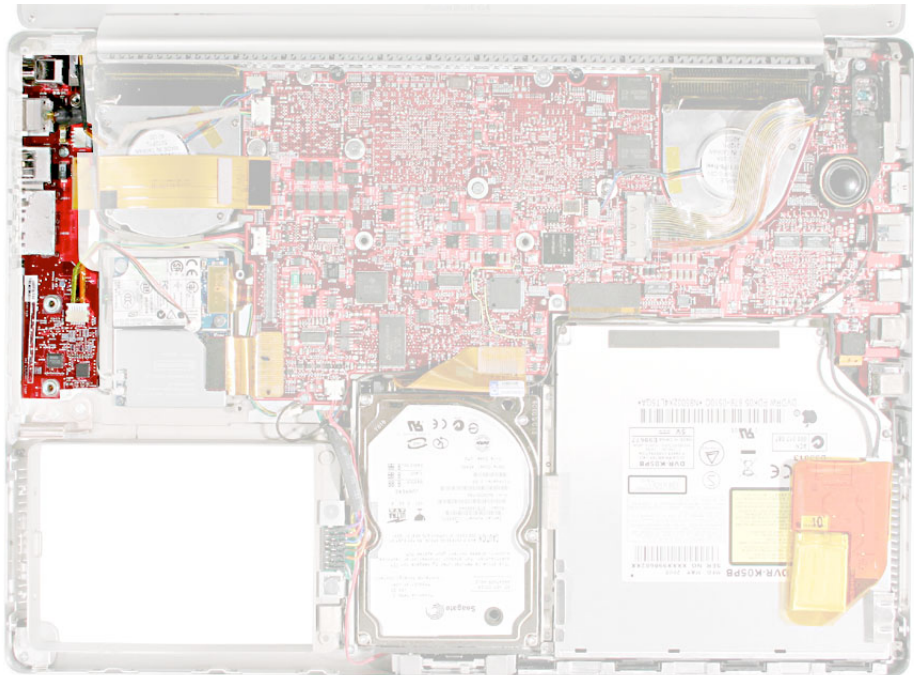

Preliminary Steps

Before you begin, remove the following:

- Battery
- Top case
- PC card cage

Procedure

1. Disconnect the flex connector, speaker wire, power cable, and remove the screw and hexnut screw.

922-7146



14.2 mm

922-6472



4.5 mm

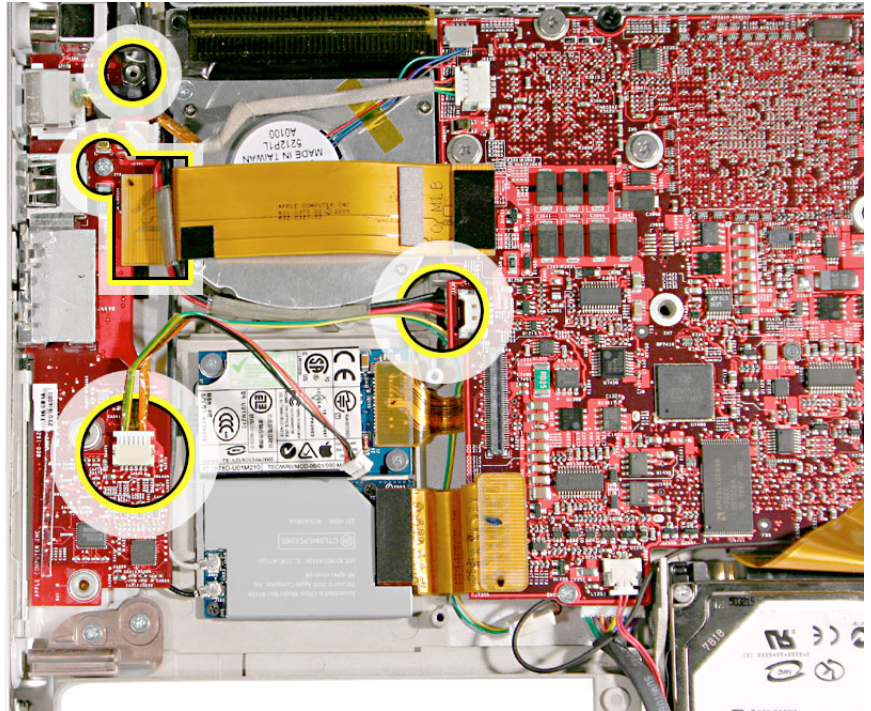

2. Move the board clear of the bottom case port openings, then rotate up.

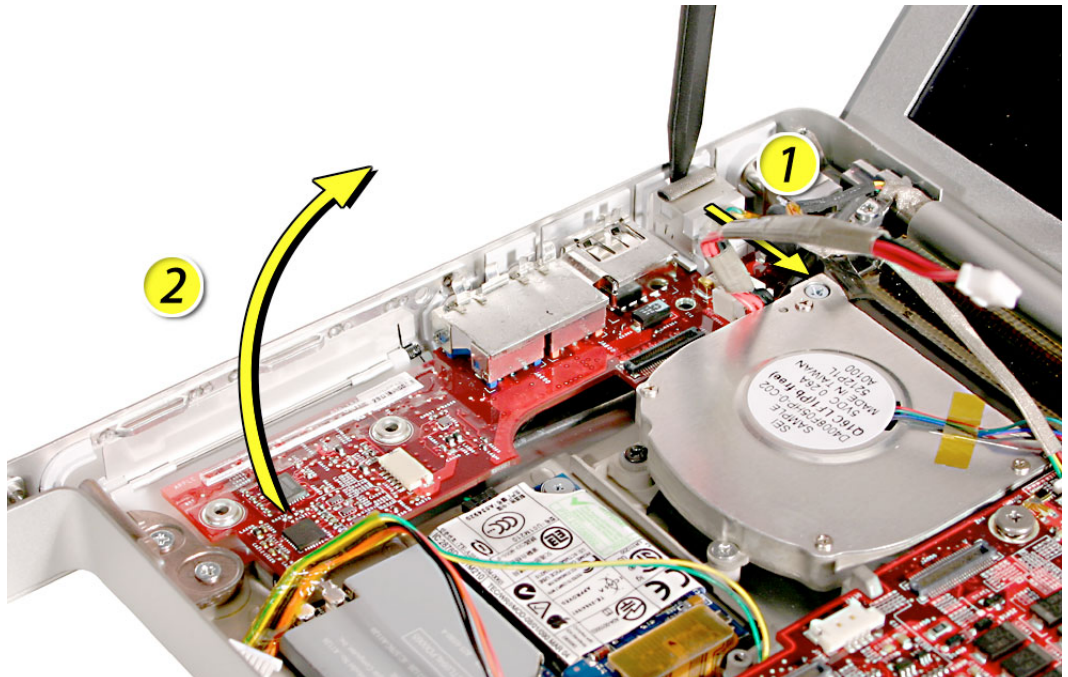

3. Guide out the DC-in port.

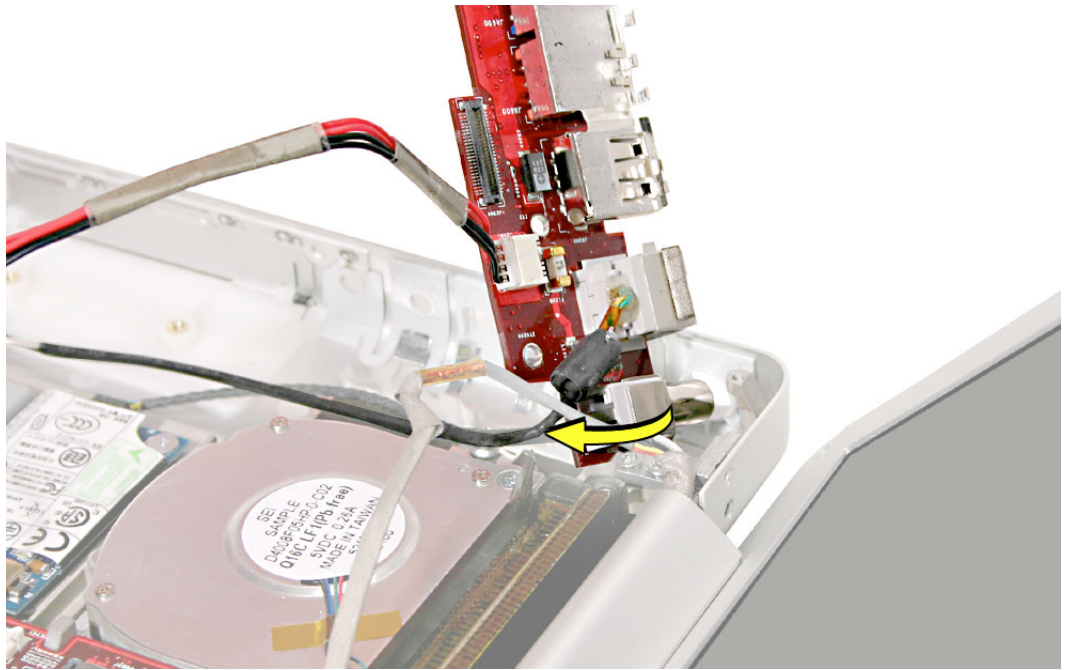

4. Guide out the DC-in port.

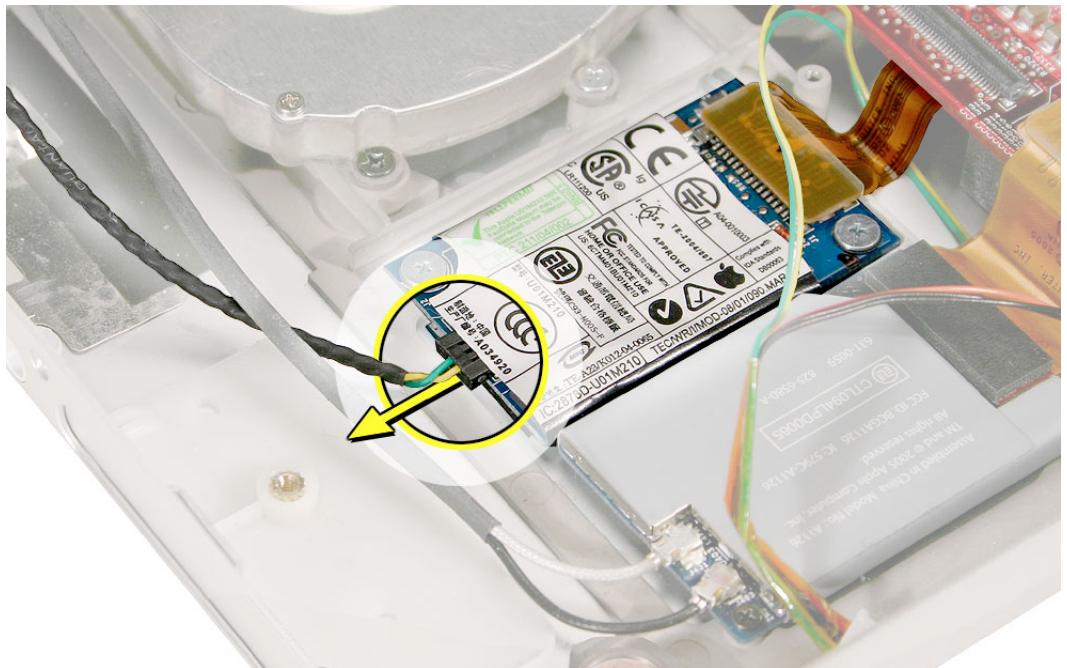

5. Disconnect the power cable.

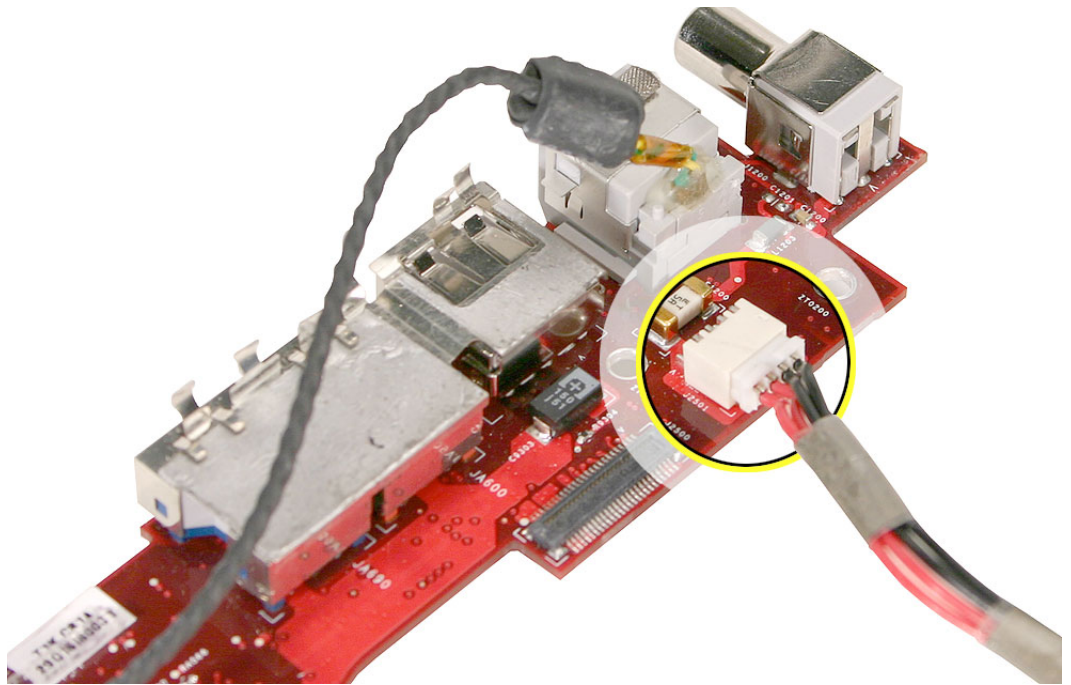

6. Slide out the RJ-11 port with cable and transfer it to the replacement board.

Note: Pull on the port, or push it with the flat blade of a black stick, until it begins to move, then use the black stick to create leverage behind the port.

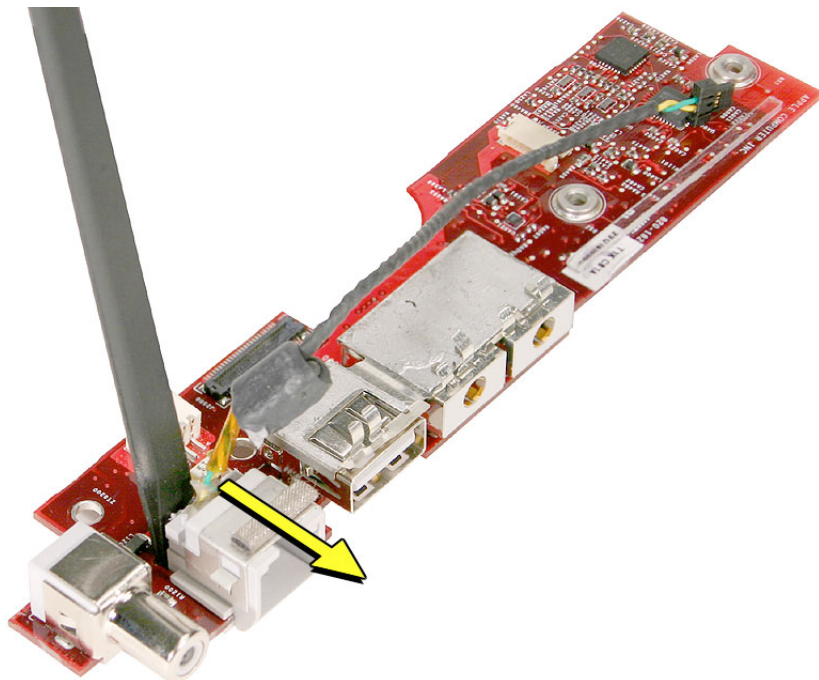

7. Verify that the rubber block is on the replacement board, or transfer from the replaced board.

Replacement Note: Use care during reassembly that the block is not dislodged.

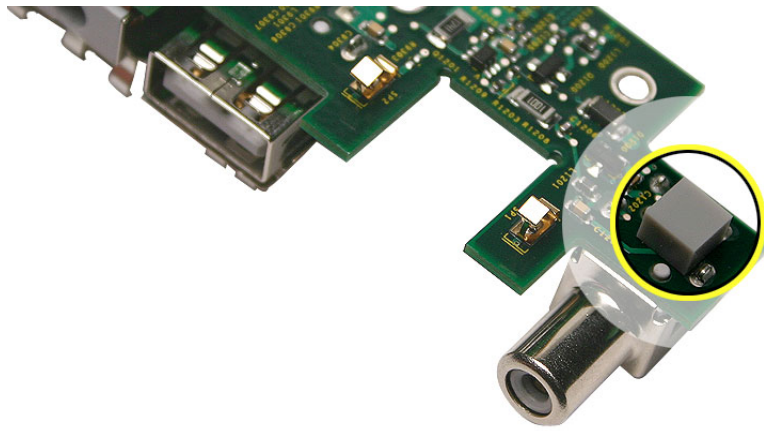

8. Install the replacement sound/DC-in board.

Replacement Notes:

- Connect the power cable to the sound/DC-in board, and the modem cable to the modem, before installing.
- Verify that the screw pass-through holes, near the speaker wire connector, line up with the PC card cage screw bosses below them.

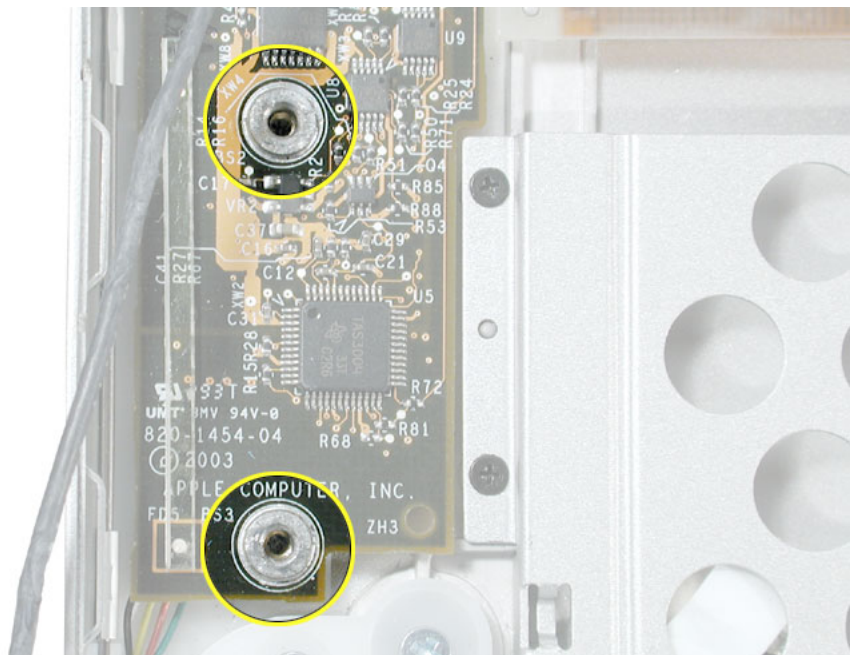

- While tightening the screws, push the board toward the port holes in the bottom case to ensure the DC plug is fully seated into its port.
- Verify that the port EMI metal rests above the port plastic.
- Verify that the EMI gasket is installed (076-1201).

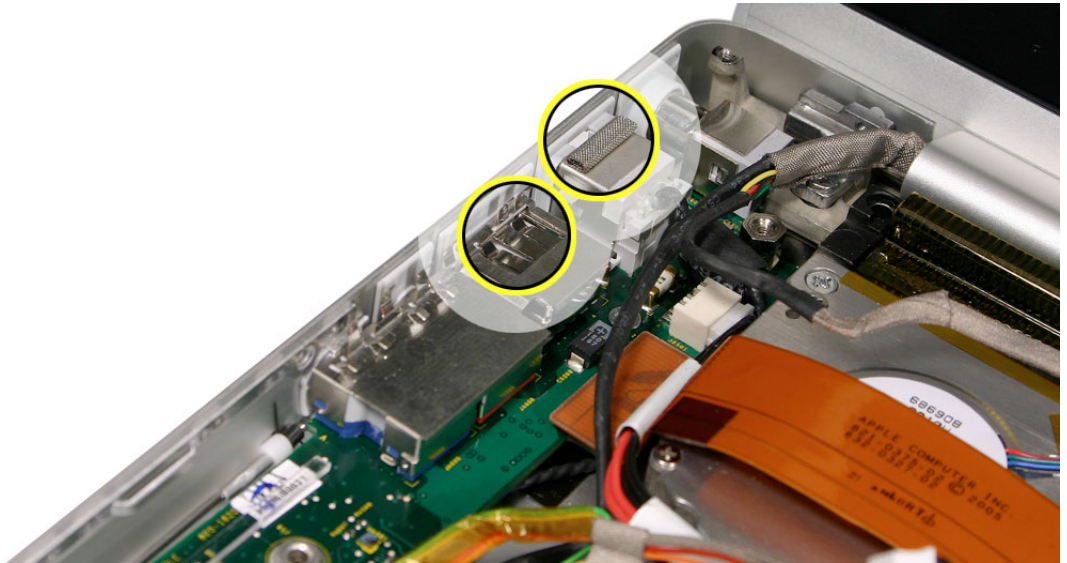

9. Connect the speaker and flex cables.

Note:

- Install the “TO MLB” side of the flex cable to the logic board.
- The flex cable should go under the sound/DC-in board power cable.

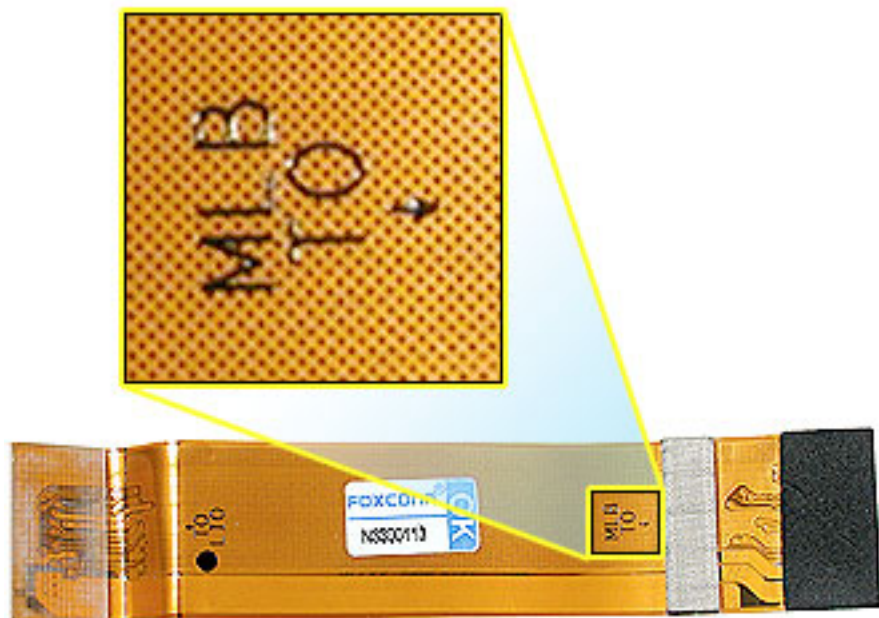

-
10. Reassemble and test the computer.
 11. Testing should include checking the function of the modem port, DC-in port, the left USB port, and audio ports.



Speaker cable

Tools

This procedure requires the following tools:

- #0 Phillips screwdriver (magnetized)
- Black stick (or other nonconductive nylon or plastic flat-blade tool)

Part Location

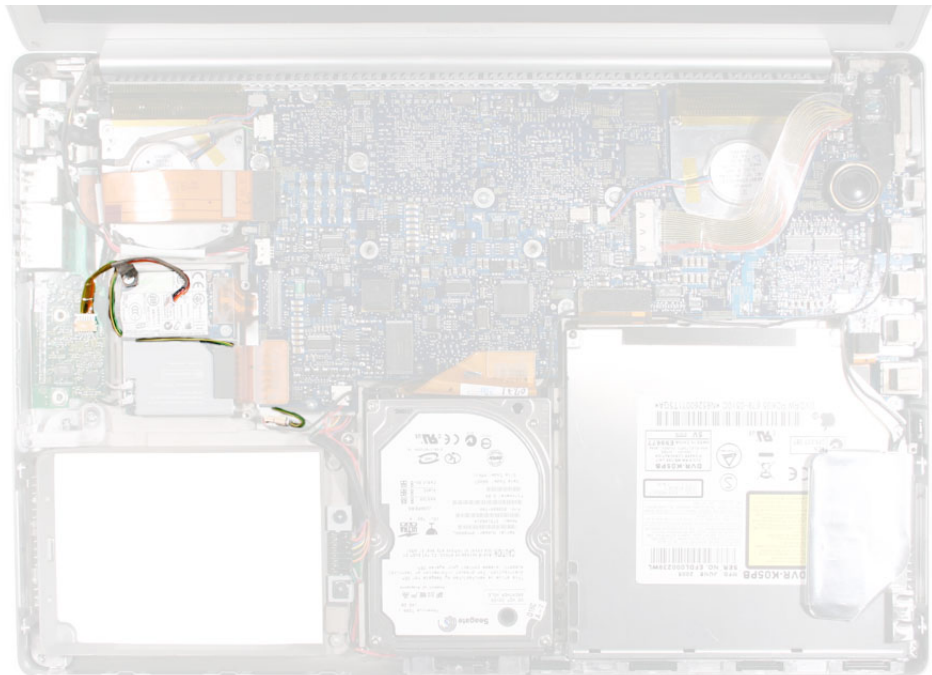

Preliminary Steps

Before you begin, remove the following:

- Battery
- Top case
- Left speaker
- PC card cage

Procedure

1. Disconnect the cable where shown and remove one screw attached to the modem.

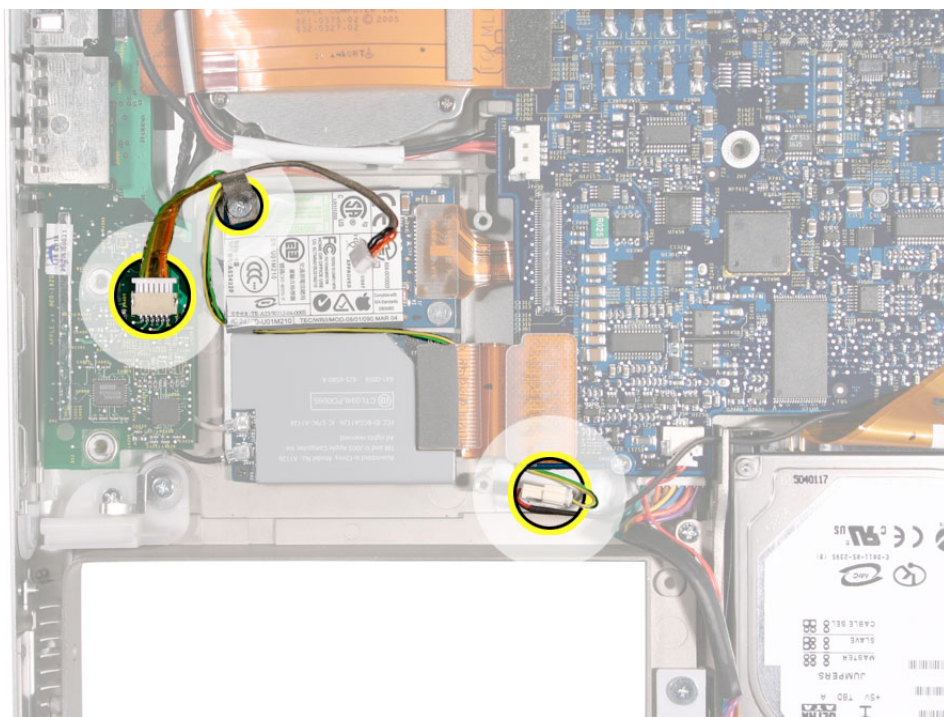

2. Install the replacement speaker cable. Make sure to capture the metallic strap with the modem screw, and route the cable as shown above.



Logic Board

Tools

This procedure requires the following tools:

- #1 Phillips screwdriver (magnetized)
- Gasket kit (076-1201)
- Black stick (or other nonconductive nylon or plastic flat-blade tool)
- Alcohol pads
- Thermal Grease (922-7144)

Note: Use a tray with divided compartments to organize the screws you remove.

Part Location

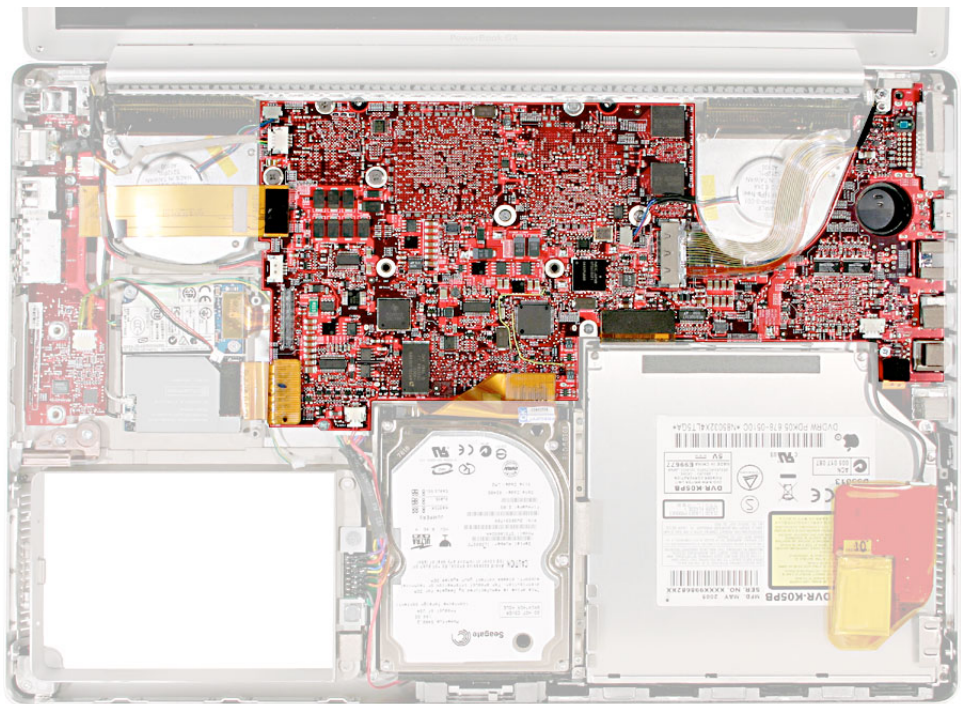

Preliminary Steps

Before you begin, run the computer until warm (if possible) to help soften the thermal material on the logic board, then shut it down and remove the following:

- Battery
- Top case
- PC card cage
- Right speaker

Note: It may be helpful to remove the optical drive and hard drive to reduce the number of cables to control when replacing the logic board, if desired.

Procedure

1. Disconnect the cables shown.

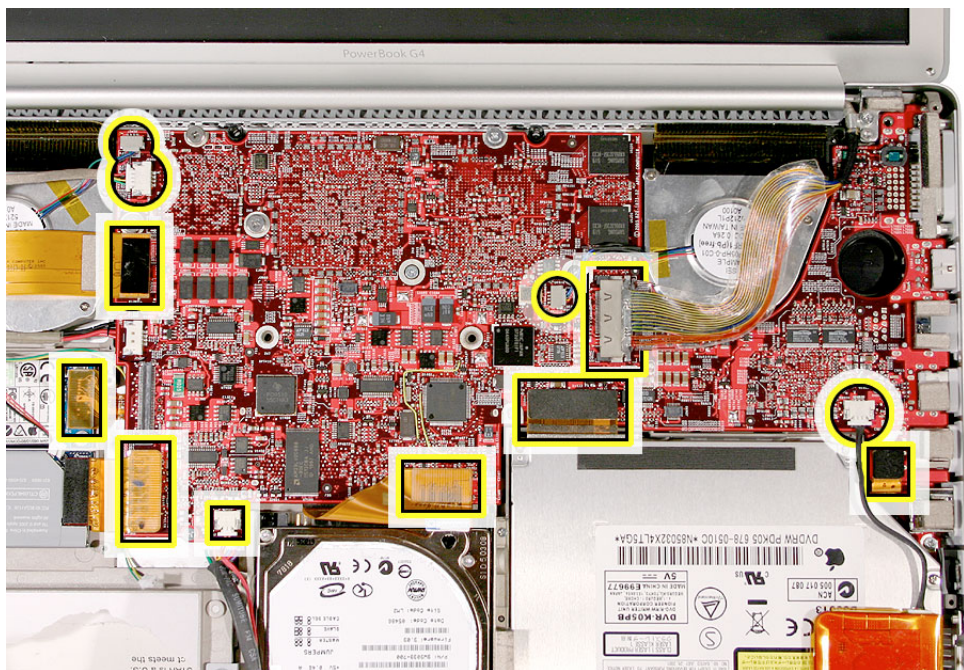

2. Remove the screws.

922-6473



6.9 mm

922-6472



4.5 mm

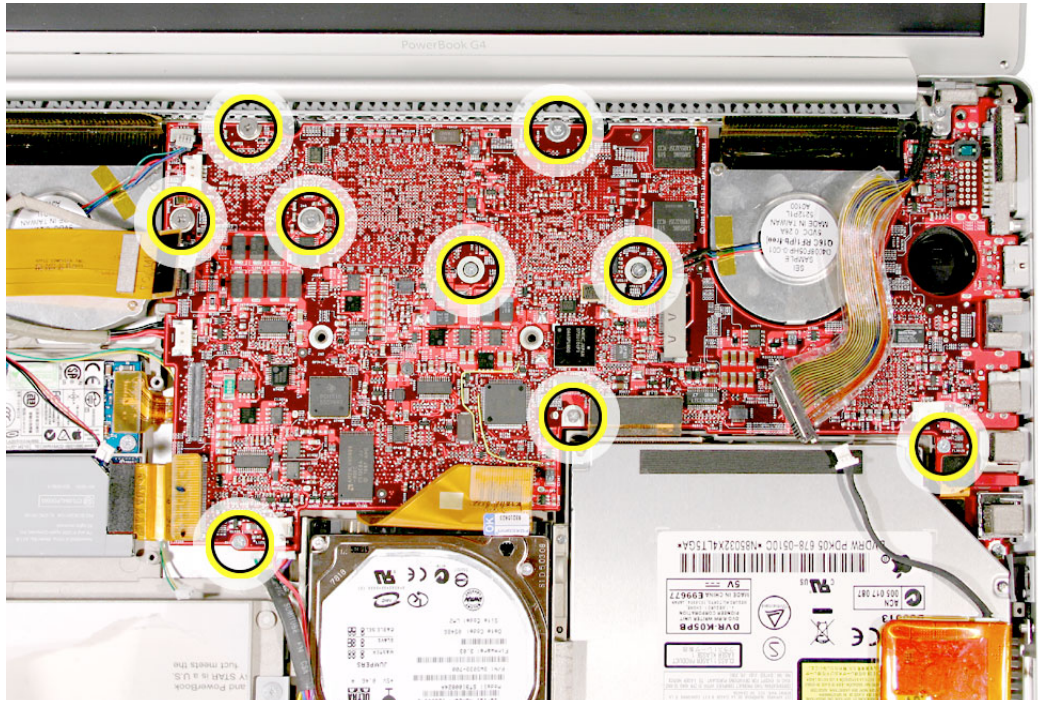

Warning: Do NOT allow the logic board to flex. Flexing the board can break solder joints to components. Give special attention at the narrow neck of the blower cutout.

Important: Verify that the thin metal washer, attached over the screw notch, shown below, does not fall off into the computer.

Replacement Note: Transfer this washer to the replacement board when installing.

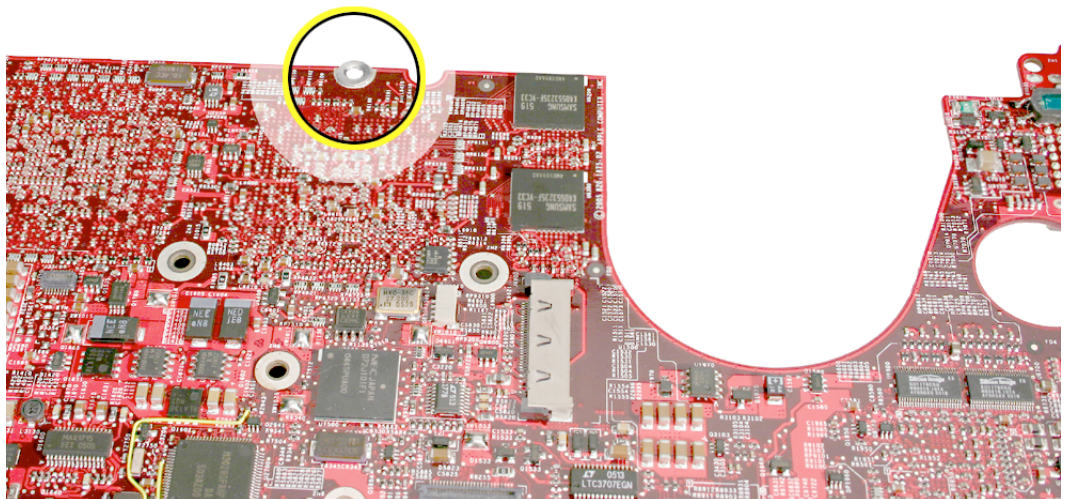

3. Use a black stick to lift the left side of the board slightly.

Note: The thermal material should easily release. If not, apply slow constant pressure until it releases, avoid over flexing.

4. Remove the two connectors, shown.

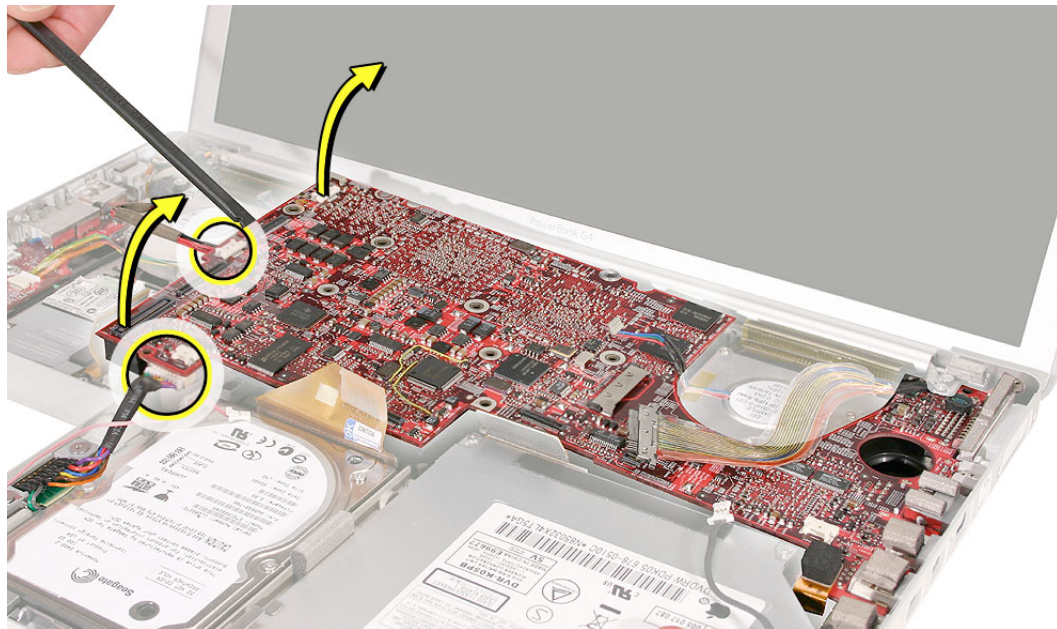

5. Carefully lift the left side of the board and pivot along the ports side. Support the board along its sides as it lifts to avoid flexing.

Warning: Again, do not allow the board to flex, and give special attention at the narrow neck of the blower cutout.

Important: Be careful not to touch or lose the thin metal washer stuck to the board at the screw hole notch along the top. Transfer the washer to the replacement board, if not present.

6. Carefully pull the port end of the board out of the port openings.

Note: If the DVI port may catch underneath, maneuver the board until it releases.

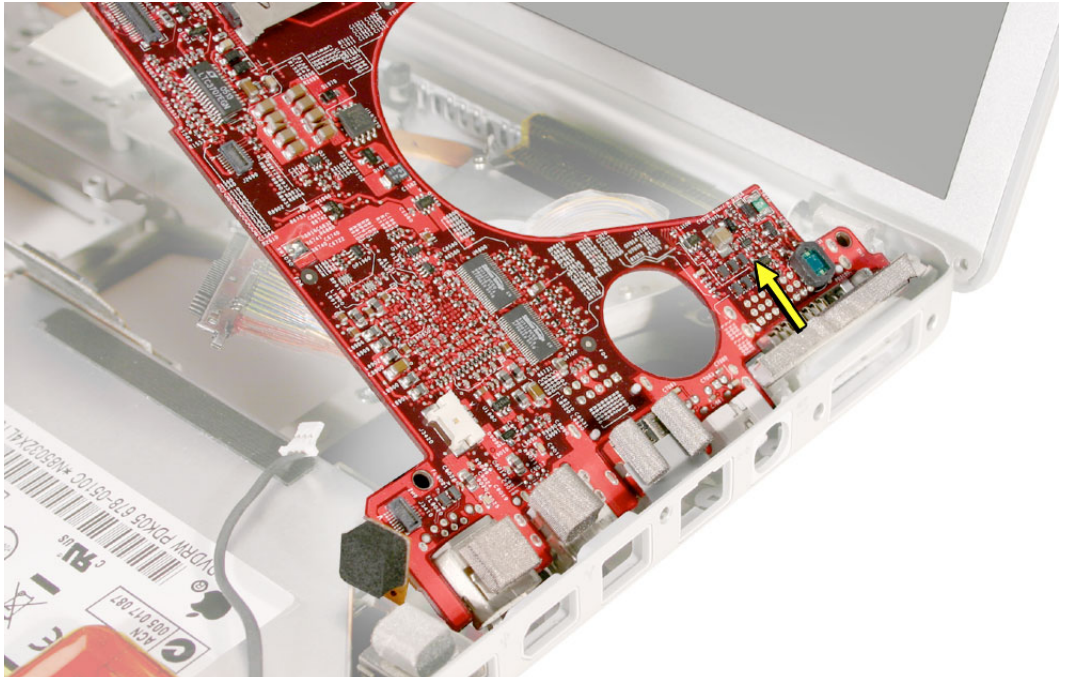

Warning: To avoid flexing the logic board, hold the board vertically along the wide sides. Do not hold the board by the ends or by the narrow neck at the blower cutout, or horizontally, as the board's weight can cause excessive flex.

Avoid touching the metal washer (if attached to board), shown, to prevent damage or dislodging.

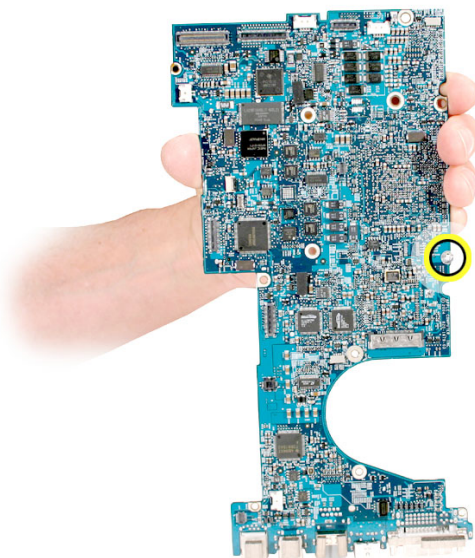

Replacement Procedure

1. Verify that the Mylar and rubber blocks are installed or transfer from the replaced board.

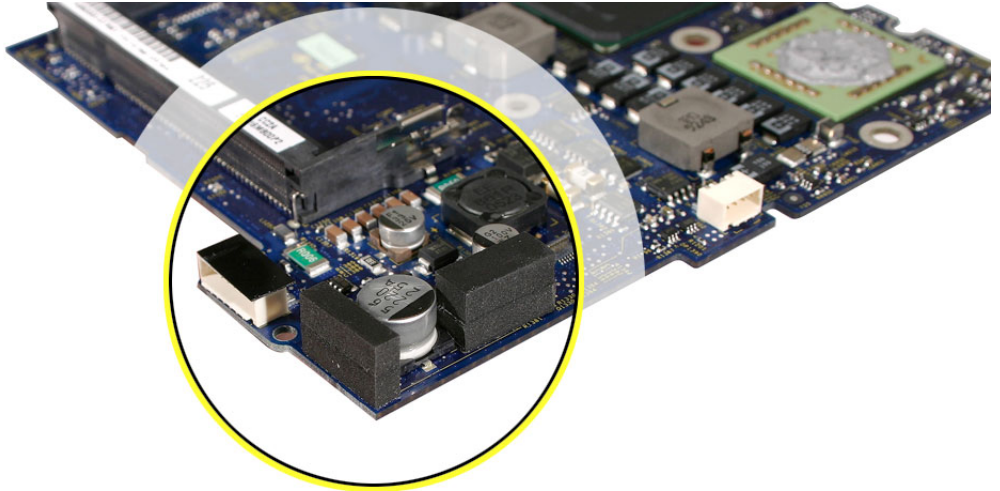

2. Install the EMI gaskets from the gasket kit (076-1201).

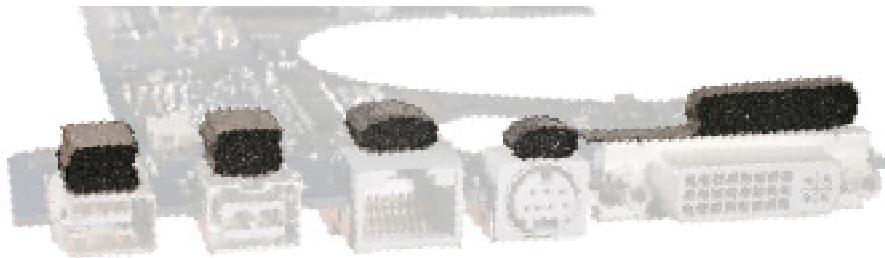

3. Install the modem flex cable. Remove any adhesive protector and secure to the board.

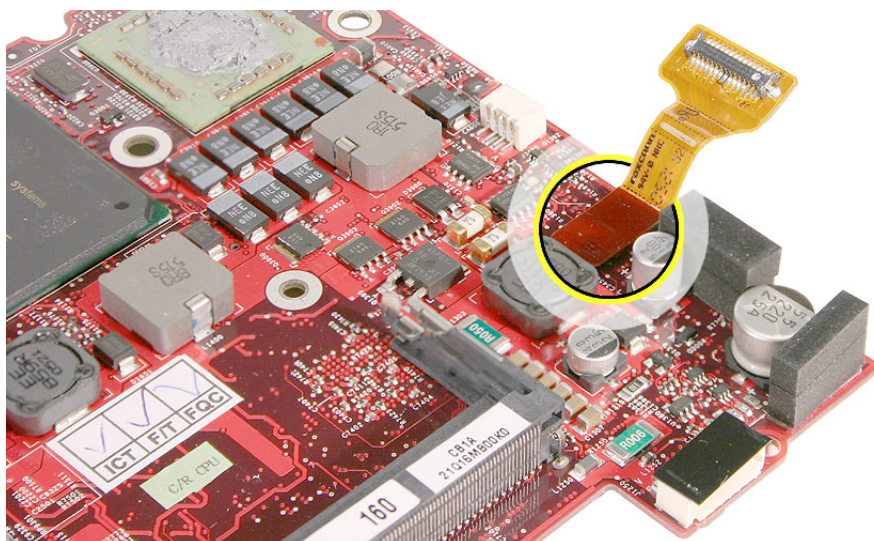

The following procedures show how to replace the thermal materials:

Warning: Whenever the logic board is separated from the heatsink, the thermal grease must be replaced. Failure to do so can cause the computer to overheat and be damaged.

When removing thermal material:

- Use a black stick to remove as much thermal grease as possible
- Use an alcohol wipes to clean the mating surface.

Important: Avoid unnecessary contact with new thermal material, as dirt and body oils reduce the thermal material's conductivity.

4. Put a 0.3cc daub of thermal grease (922-7144), in the center, on both the CPU and graphics chip mating surfaces, as shown below.

Note: One syringe of the thermal grease contains about 0.2 cubic centimeters (cc). So using about one and a half syringes should be needed per pad. If in doubt, use the picture below and apply a similar amount.

5. Verify that the center thermal pad is in place and in good condition. If not, replace the heatsink.

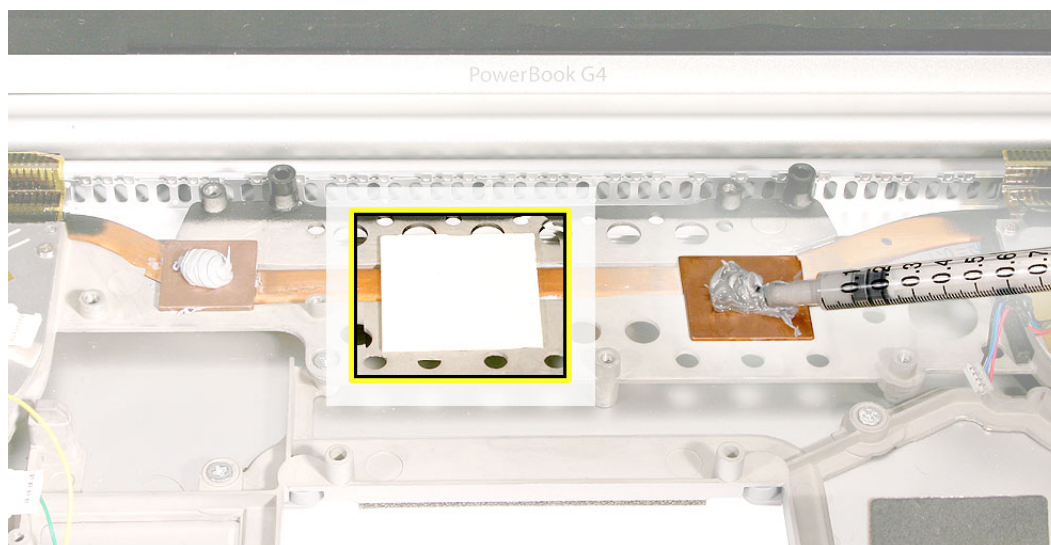

6. If the logic board was removed to facilitate another procedure and will be reinstalled, use a black stick and alcohol wipes to clean the thermal grease from the CPU and graphics chips:

Important: Use extreme care not to damage the chip or logic board components.

7. When replacing the logic board:
 - Verify that the right speaker chamber is installed.
 - Verify that the right USB board is installed.
 - Install the modem flex cable onto the logic board before installing the board.
 - Guide the logic board's port side into the port openings on the bottom case.
 - While lowering the board, connect the two cables that go under the logic board on the left side.
 - Verify that no cables are caught under the board when lowering into place.
 - Install the metal washer on the replacement logic board when securing its screw.

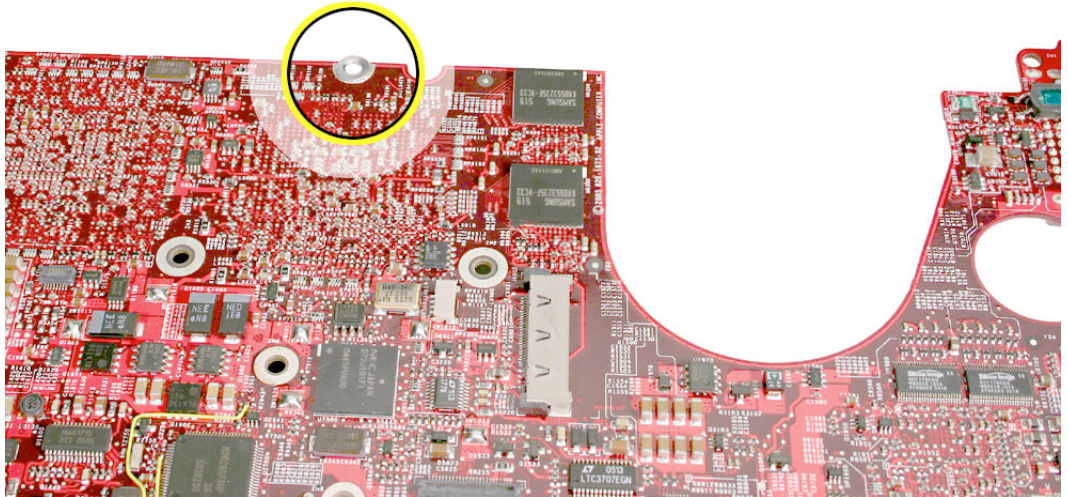

8. Attach the screws in the order shown.

922-6473
#1-3



6.9 mm

922-6472
#4-9



4.5 mm

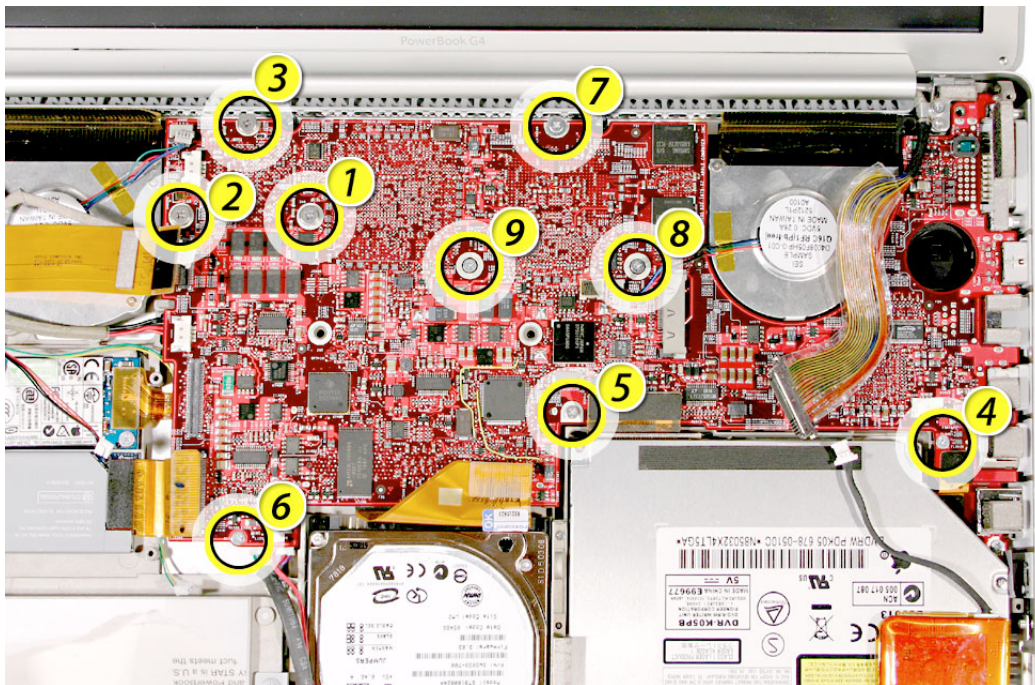

9. Reassemble and test all ports, components and functions of the computer.

Note: After installing new thermal material, if you must briefly re-separate the logic board from the heatsink, it is OK to retain the same, new thermal material, as long as they are not handled excessively.



Right Blower

Tools

This procedure requires the following tools:

- #0 Phillips screwdriver (magnetized)
- Black stick (or other nonconductive nylon or plastic flat-blade tool)

Part Location

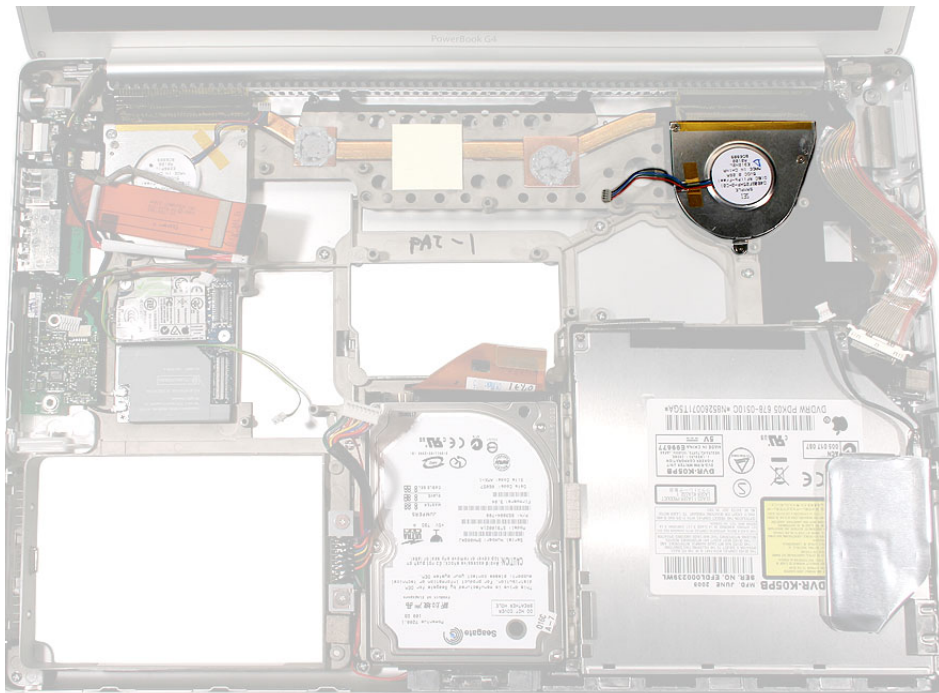

Preliminary Steps

Before you begin, remove the following:

- Battery
- Top case
- Logic board

Procedure

1. Remove the three screws, then lift off the blower.

922-6093



4.5 mm

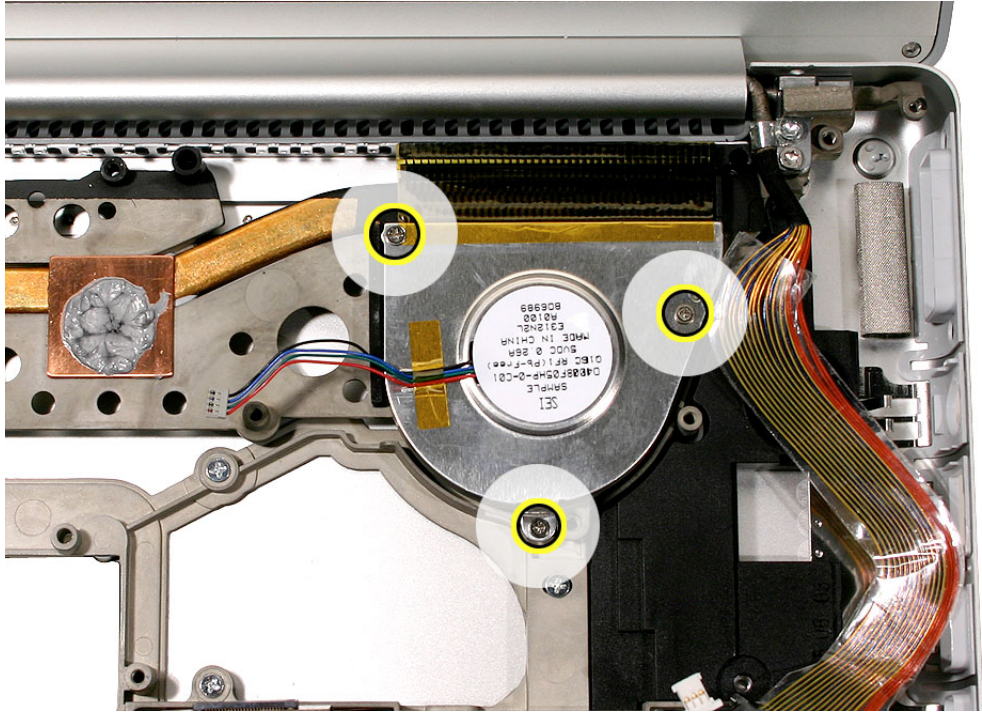

2. Install the replacement right blower.
3. Verify that Kapton tape covers the fins on the blower.

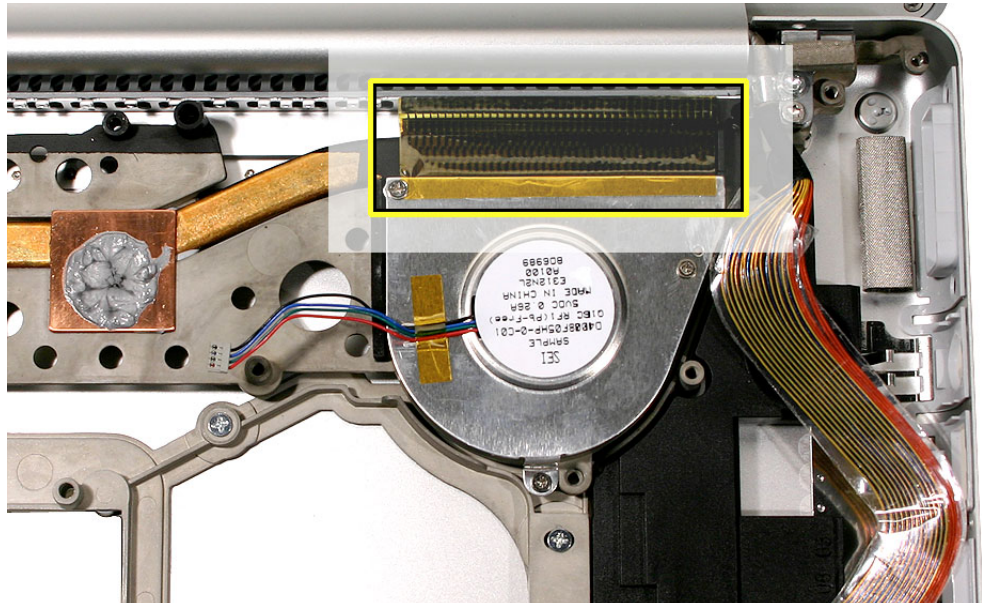

4. Reassemble the computer and test all ports, components and functions.



Right USB Board

Tools

This procedure requires the following tools:

- #1 Phillips screwdriver (magnetized)
- Black stick (or other nonconductive nylon or plastic flat-blade tool)

Part Location

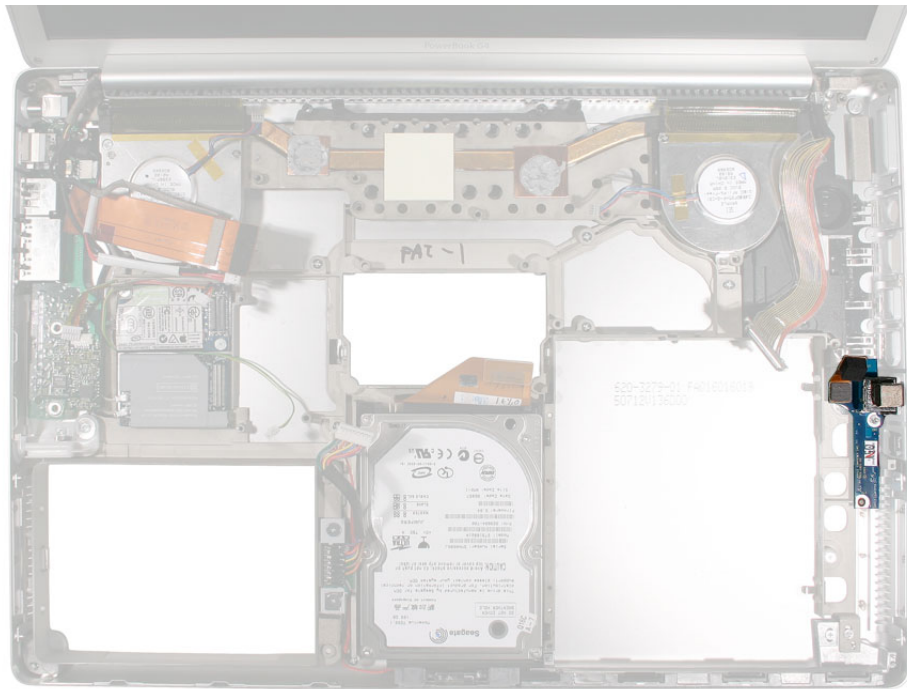

Preliminary Steps

Before you begin, remove the following:

- Battery
- Top case
- Optical drive
- Logic board

Procedure

1. Disconnect the flex cable.

Note: The flex cable can be replaced without removing the logic board.

2. Remove the two screws and guide the board out.

922-6472



4.5 mm

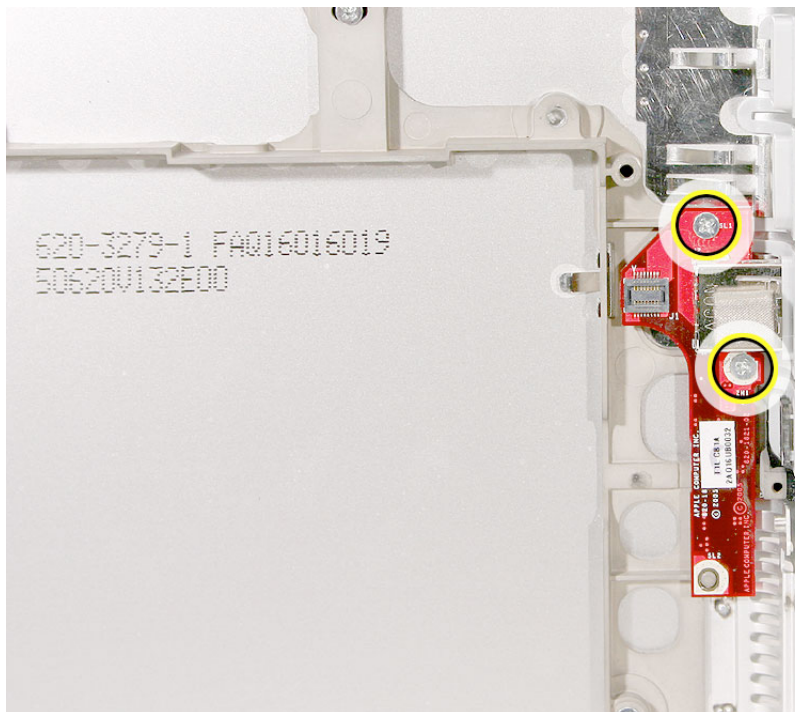

3. Install a new EMI gasket, as shown, or transfer the gasket to the replacement board.

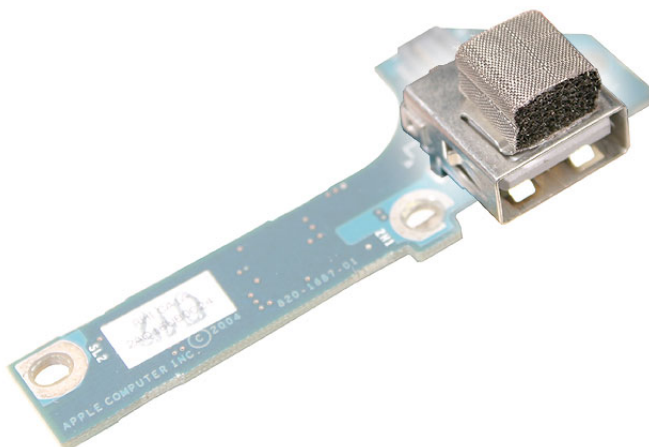

4. Install the replacement board and reassemble the computer.
5. Test all ports, components and functions of the computer.



Right Speaker Chamber

Tools

This procedure requires the following tools:

- #1 Phillips screwdriver (magnetized)
- Black stick (or other nonconductive nylon or plastic flat-blade tool)

Part Location

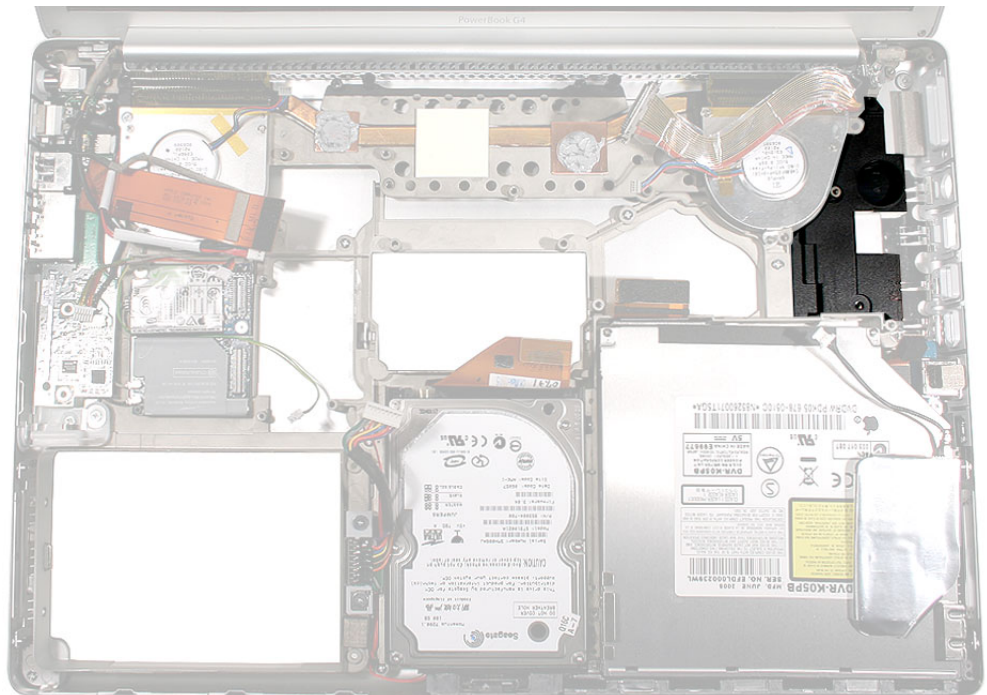

Preliminary Steps

Before you begin, remove the following:

- Battery
- Top case
- Logic board

Procedure

1. Remove two screws.

922-6474



5.5 mm

922-6472



4.5 mm

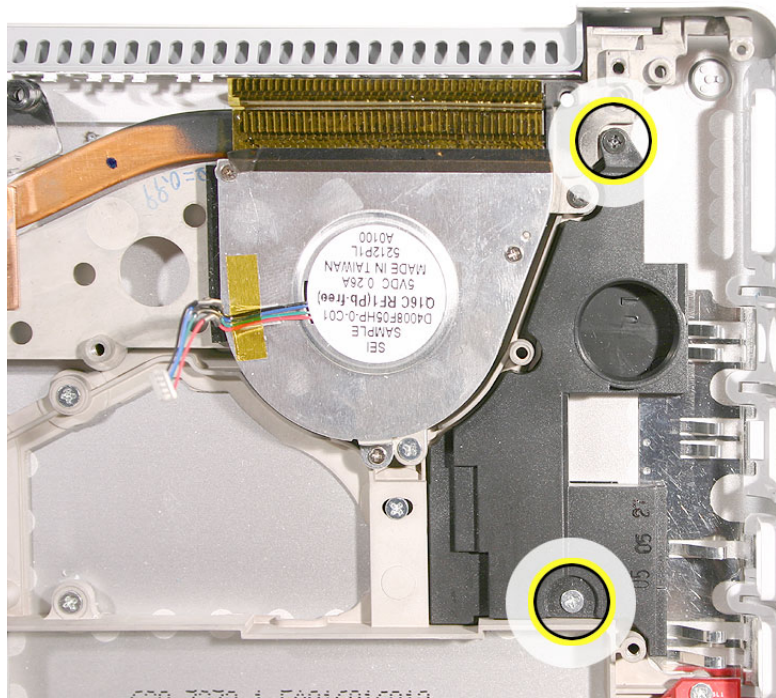

2. Reassemble the computer.
3. Test all ports, components and functions of the computer.



Heatsink and Blowers Assembly

Tools

This procedure requires the following tools:

- Torx T8 screwdriver (magnetized)
- #1 Phillips screwdriver (magnetized)
- Thermal grease (922-7144)
- Alcohol pads

Part Location

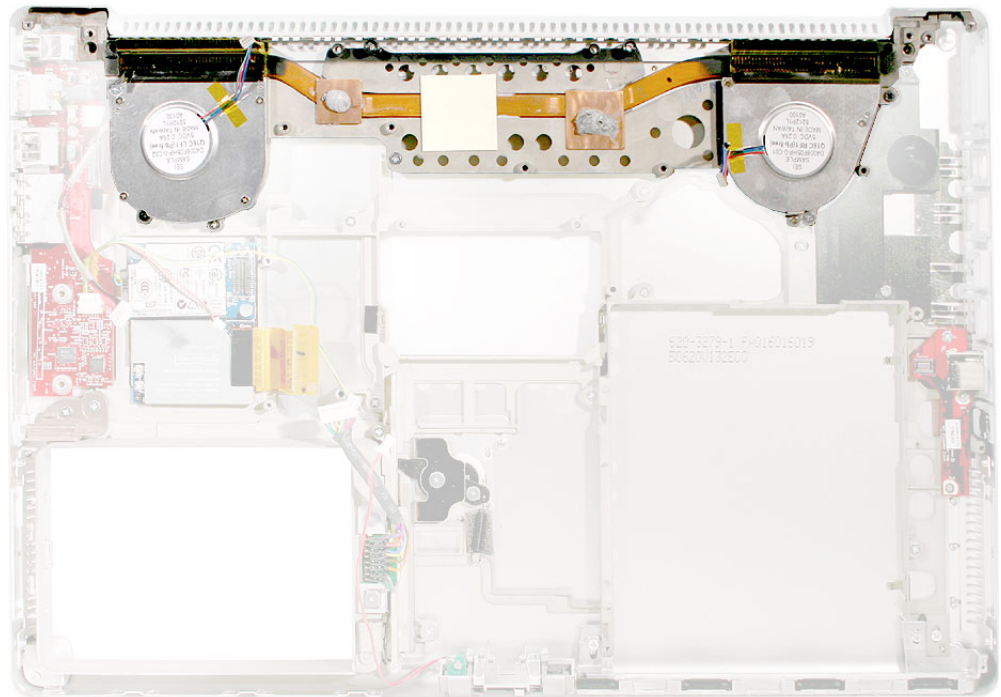

Preliminary Steps

Before you begin, remove the following:

- Logic board
- Right speaker chamber

Procedure

Note: The heatsink and blowers are one assembly part.

1. Remove the screws and lift out the heatsink and blower assembly.

922-6475



9.5 mm

922-6474



5.5 mm

922-6472



4.5 mm

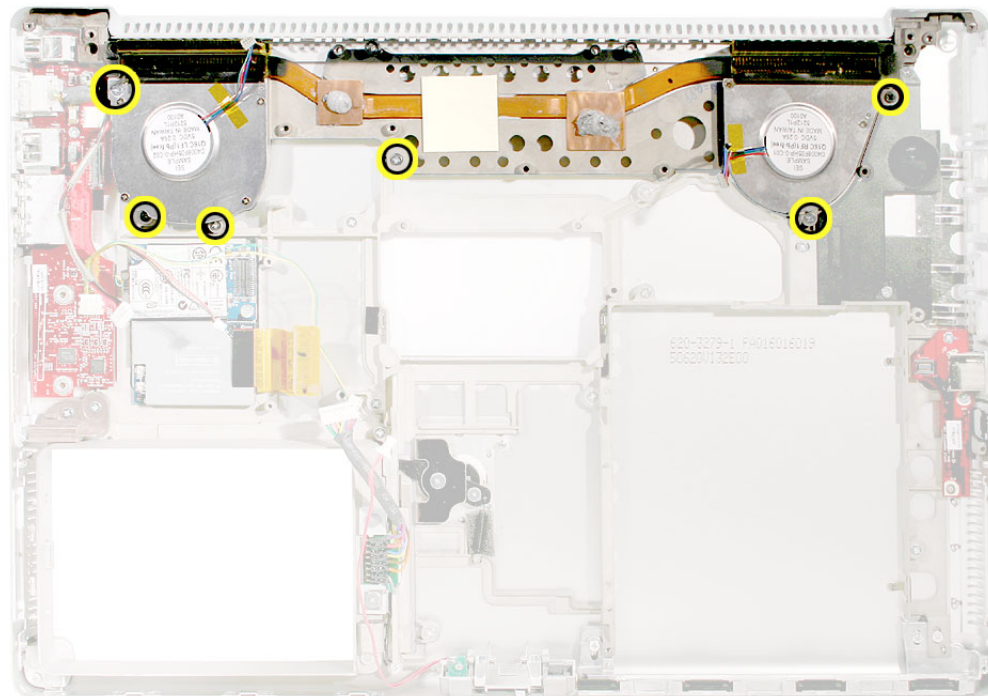

Important: Do not attempt to transfer blowers from one heatsink to another. This can create acoustic and heat issues.

2. If the heatsink was removed to facilitate another procedure and will be reinstalled, follow the procedures in the Logic Board chapter about replacement of thermal pads.
3. If installing a replacement heatsink, and the thermal pads are not pre-installed, follow the procedures in the Logic Board chapter to install the thermal pads.

Important: Do not install a heatsink with damaged or missing thermal pads.

4. Verify that Kapton tape covers the fins behind each blower, on the top and bottom.

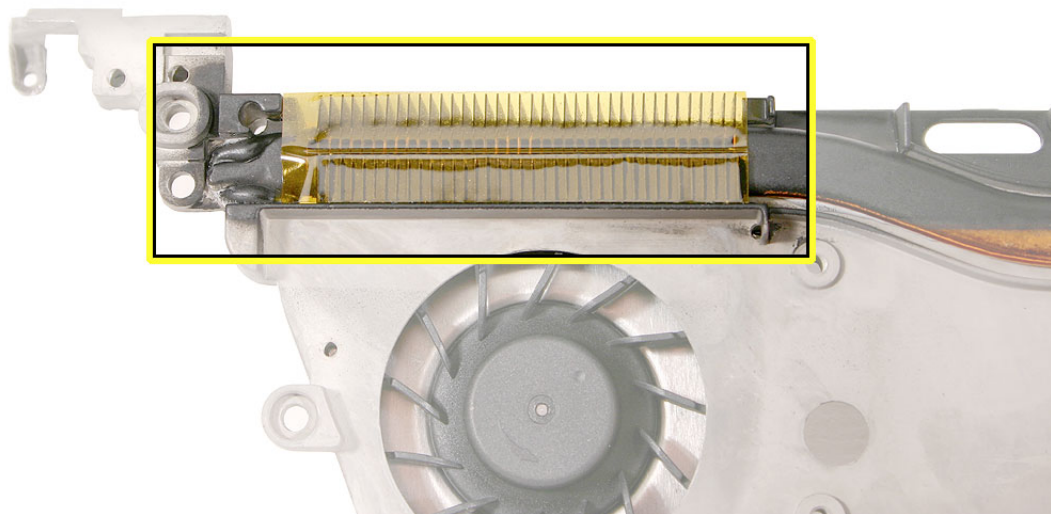
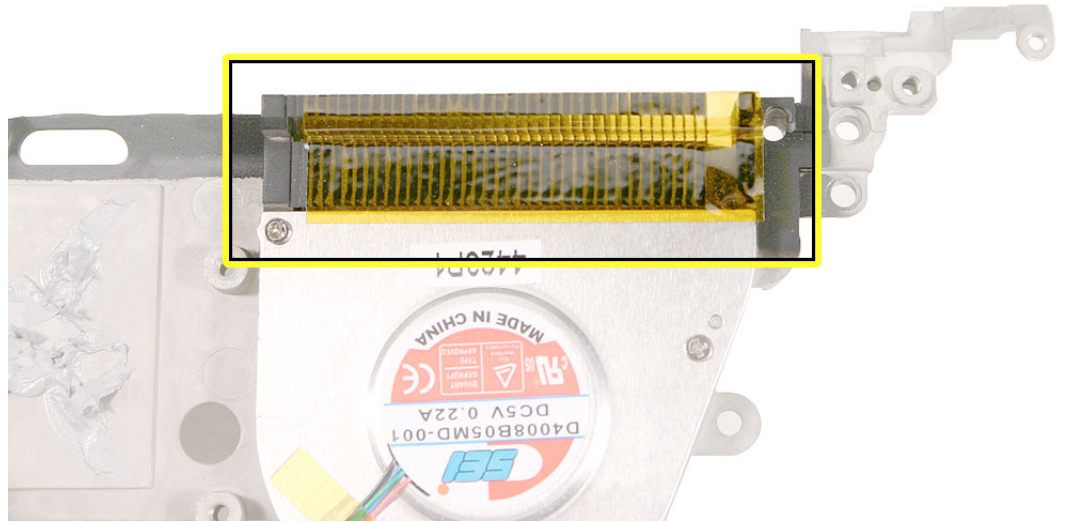

5. To install the replacement heatsink, install the screws in the order shown.

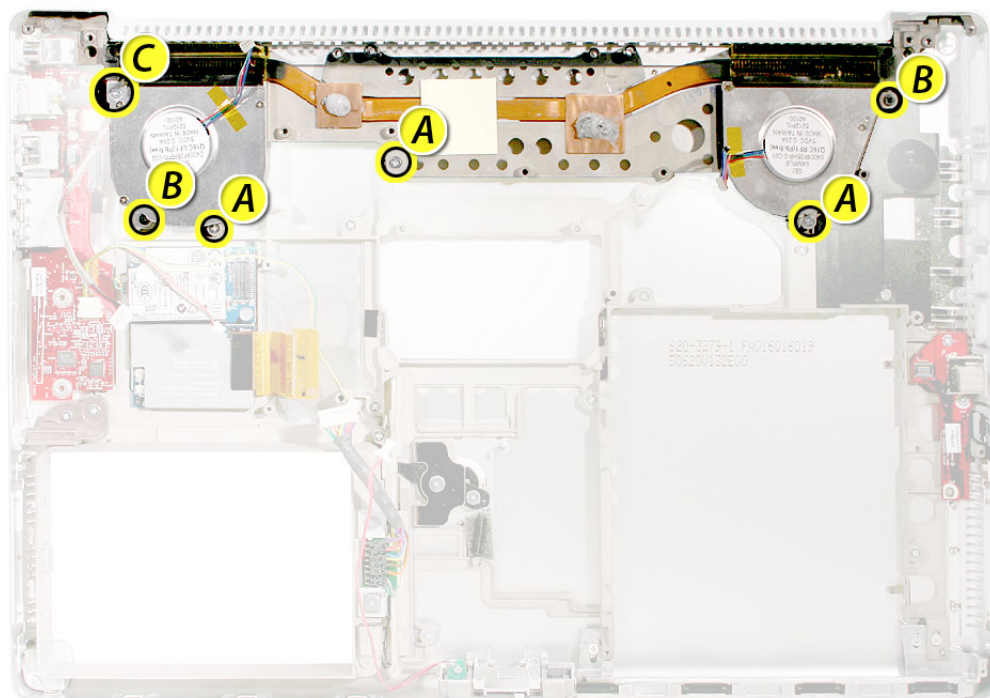

6. Reassemble and test all ports, components and functions of the computer.



Bottom Case Assembly

Part Location

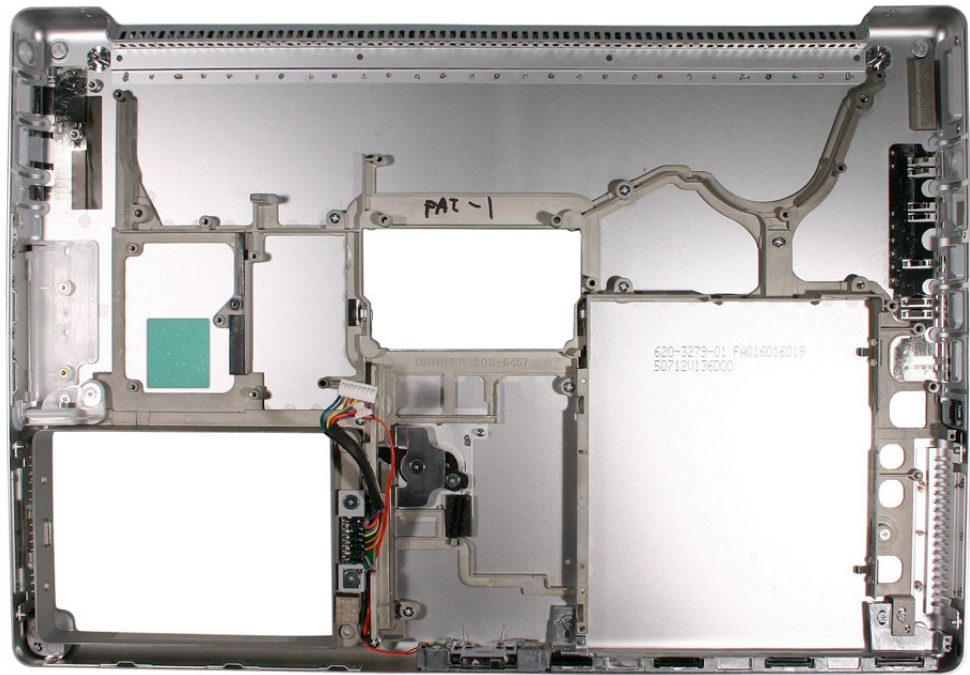

Preliminary Steps

Before you begin, remove the following:

- Battery
- Top case
- Optical drive
- Hard drive
- Right USB board
- AirPort Extreme/Bluetooth card
- Modem
- Sound/DC-in board
- Logic board
- Right speaker chamber
- Display panel assembly
- Heatsink

Procedure

1. Verify that the following items are on the replacement bottom case, transfer if needed:
 - Display latch assembly
 - Sleep LED and wire connector assembly
 - Battery latch assembly
 - Left hard drive holder
 - Foam support pad under AirPort Extreme w/ Bluetooth card location
 - Two rubber support pads for modem and AirPort Extreme w/ Bluetooth card

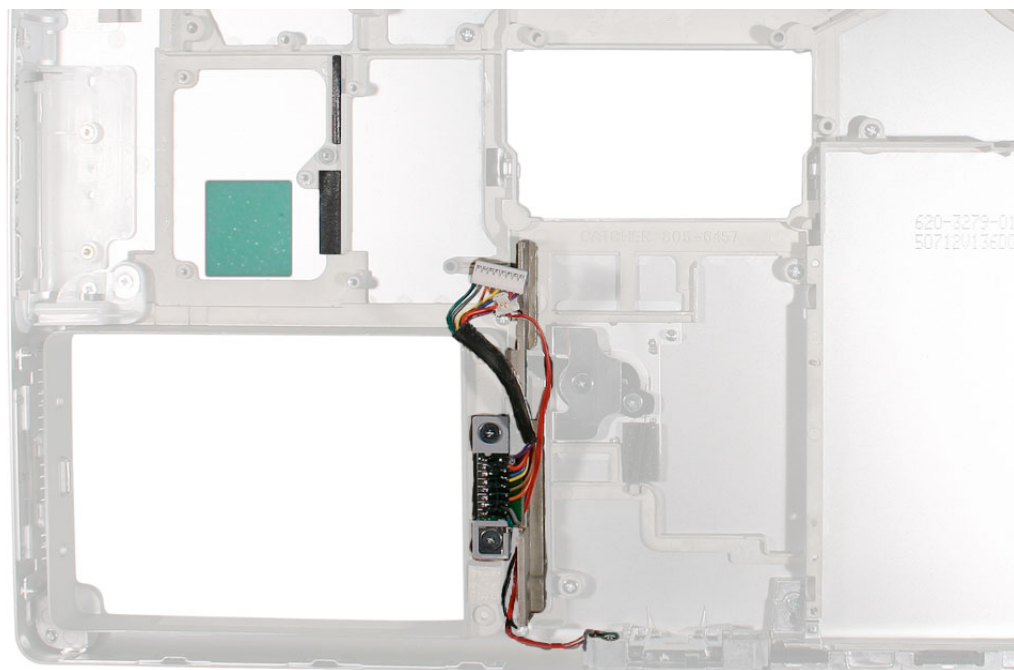

- EMI gasket under DVI port

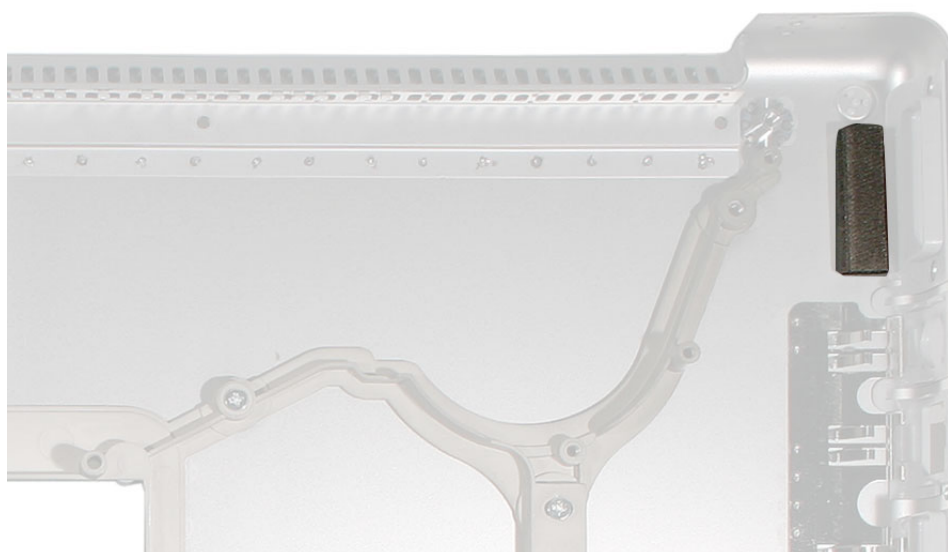

2. If not present on the replacement bottom case, transfer the battery connector and cable assembly by removing the two connector screws and one grounding screw.

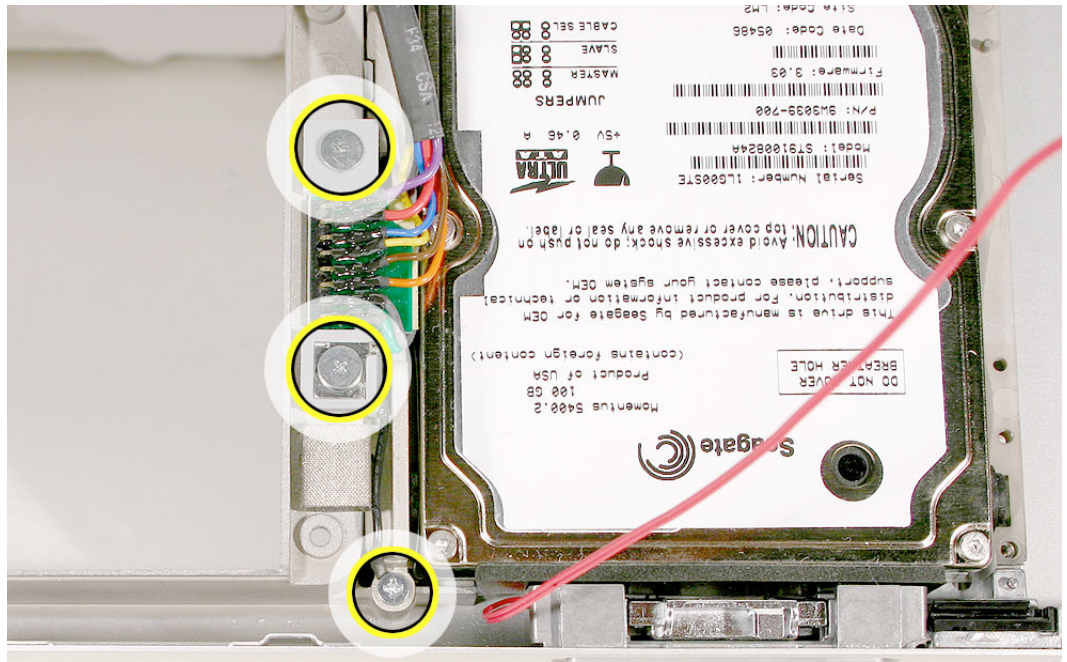

3. If not present on the replacement bottom case, transfer the left hard drive holder by removing the two screws.

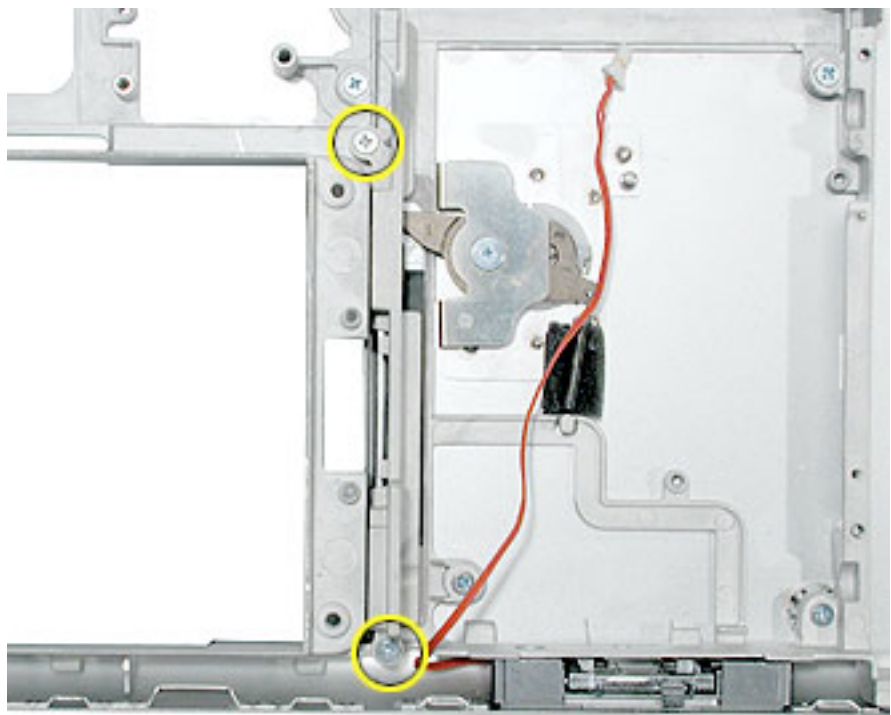
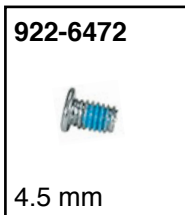

4. Install the EMI gasket on the replacement bottom case, as shown below, or transfer.

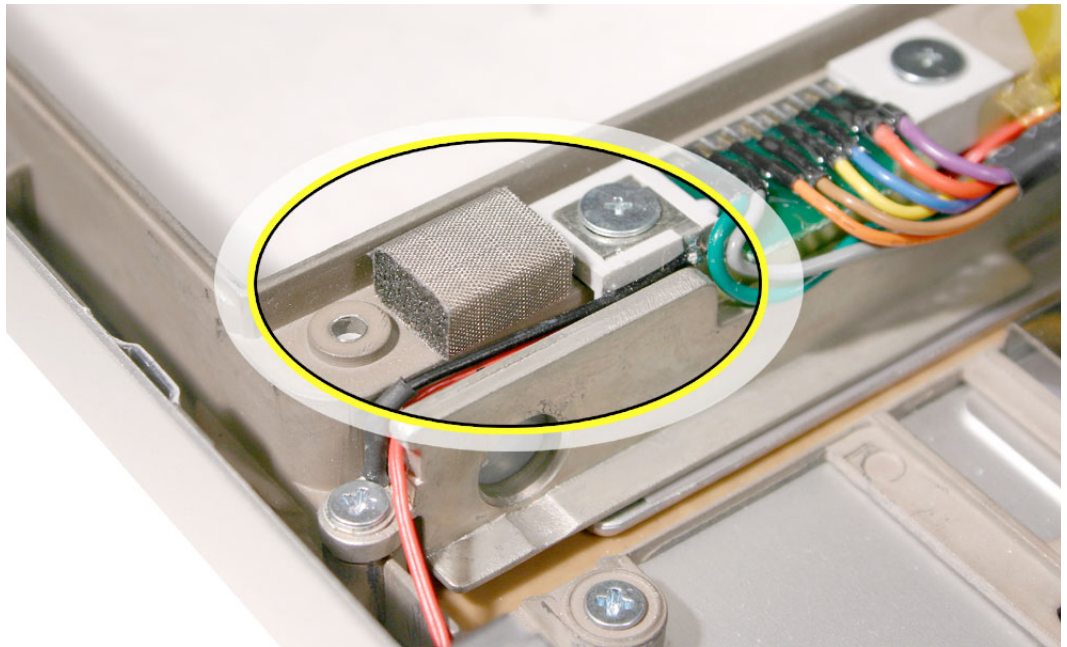

5. Reassemble and test all ports, components and functions of the computer, including battery operation.



Display Panel Assembly

Note: On this model, the Display Panel Assembly is not available as a stand alone part.

Tools

This procedure requires the following tools:

- Torx T8 screwdriver (magnetized)
- Black stick (or other nonconductive nylon or plastic flat-blade tool)

Part Location



Preliminary Steps

Before you begin, remove the following:

- Top case
- Left speaker
- PC card cage

Procedure

1. Remove the two screws along the back, closest to the bottom of the computer.

922-6100



5.3 mm



2. Open the computer display.
3. Disconnect the Sound/DC-in board flex and power cables.

Note: Peel up Kapton tape as needed.

4. Disconnect the inverter cable.
5. Disconnect the antenna cables.

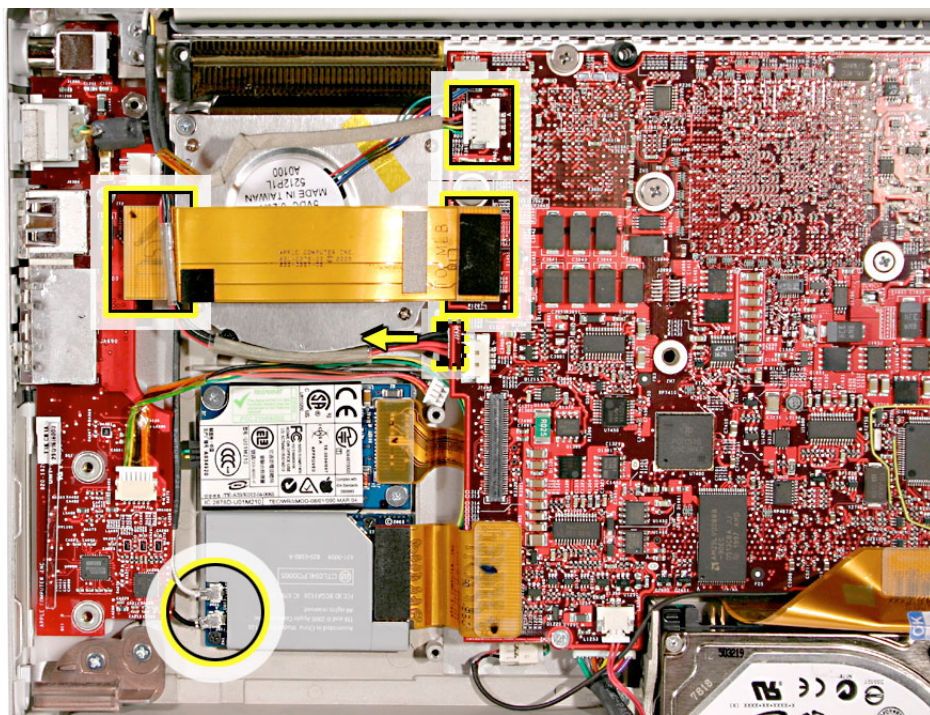

6. On the right side of the computer, disconnect the LVDS cable.

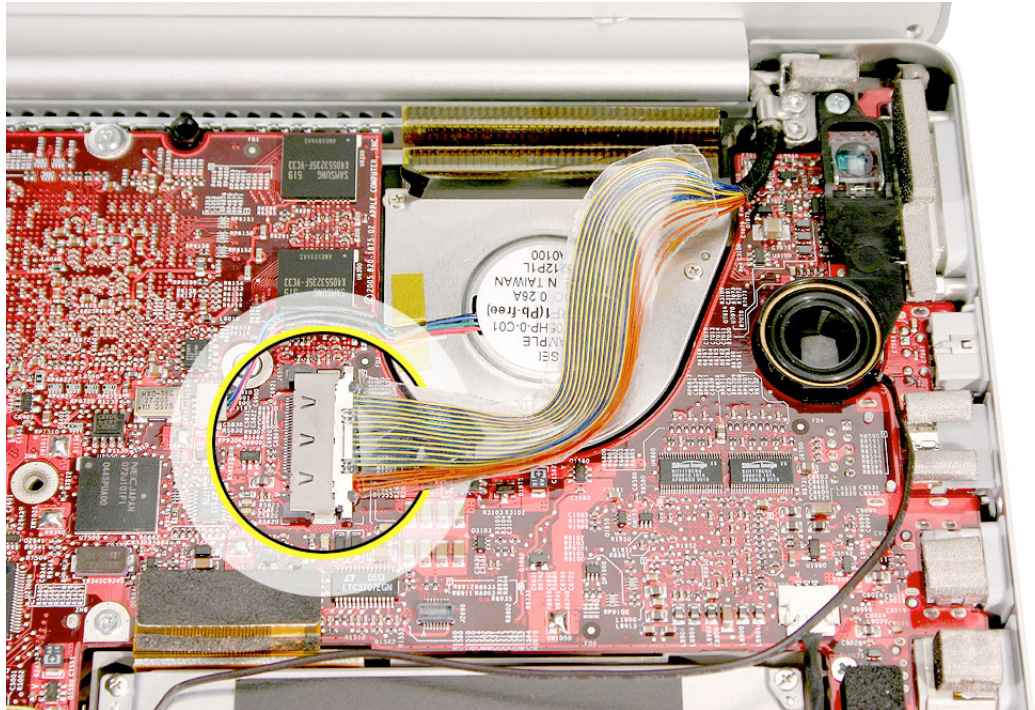

7. Move the display to a 90-degree angle and remove the four screws.

Important: Support the display from falling over before removing the last screw.

922-6471



10.25 mm

922-6098



13 mm

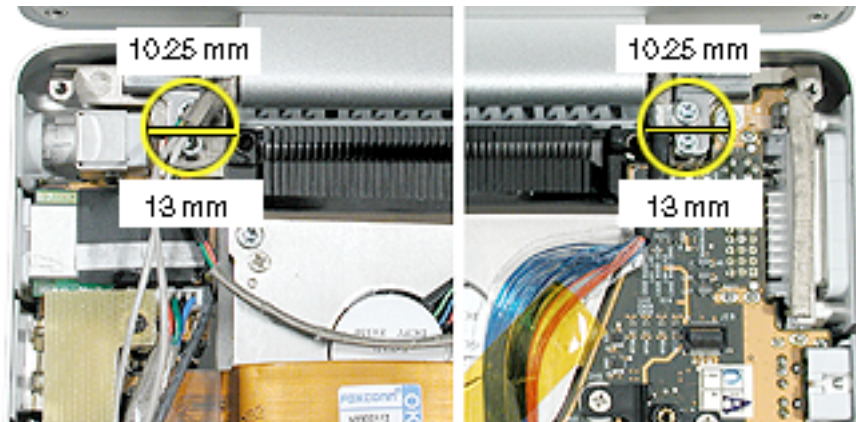

- Lift the display straight up and off of the computer without catching wires.

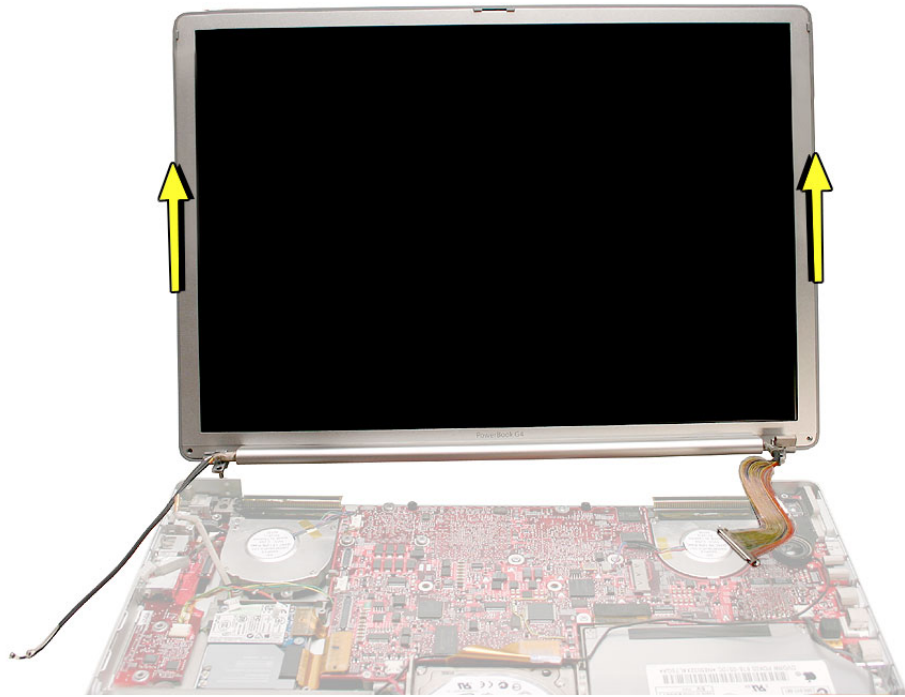

- Install the replacement display panel assembly.

Replacement Note: Make sure to capture the grounding loop with the back screw.

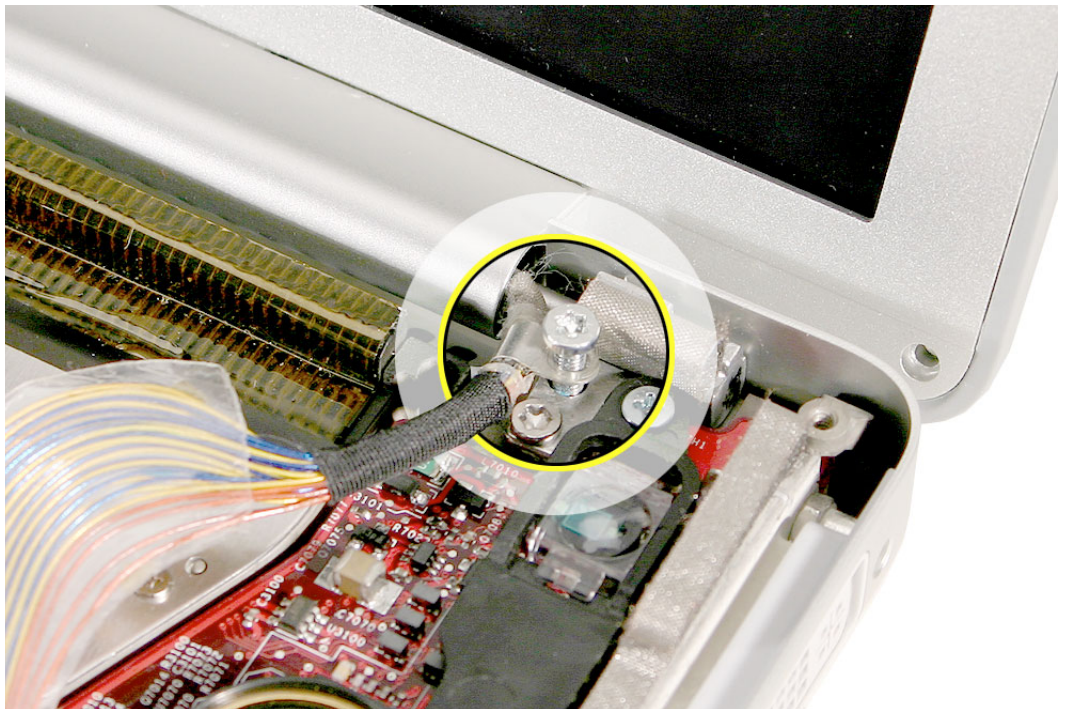

10. **Replacement Note:** Verify that the right clutch EMI gasket is securely in place.

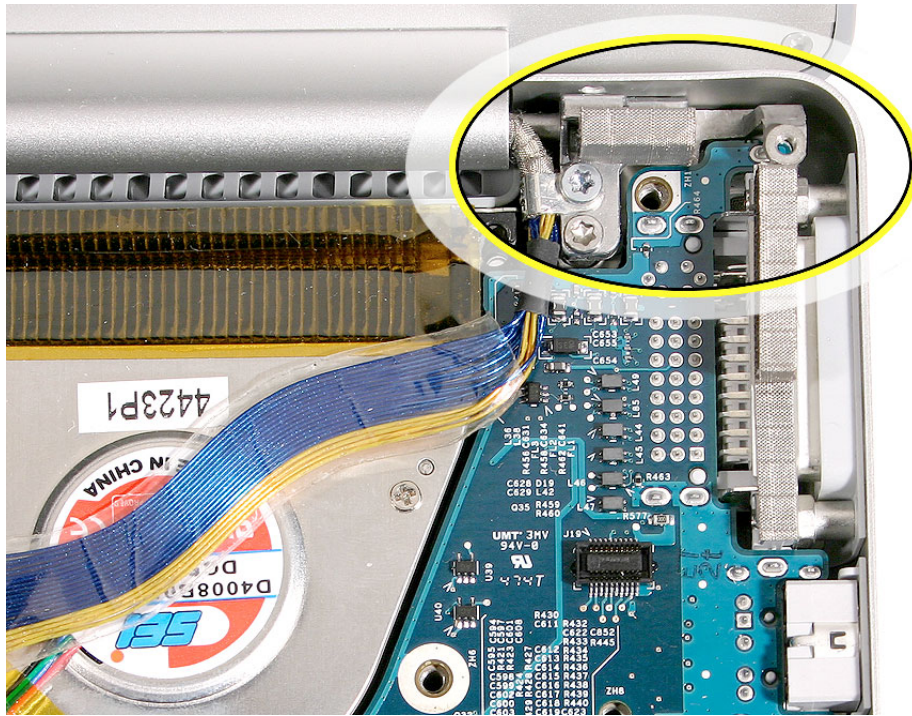

11. Reassemble and test the computer.
12. Testing the computer should include testing that the display panel functions properly. Use Apple System Profiler to check that the AirPort Extreme w/ Bluetooth card is recognized, test that AirPort Extreme and bluetooth are working, insert a PC card to check that it can be locked in and that the eject button works smoothly. Check that both speakers work, and that the trackpad and keyboard function properly. Check that the modem operates. Operate the computer in a darkened room to check for keyboard backlight function.



Display Rear Housing

Tools

This procedure requires the following tools:

- 1.5 mm Hex key (or Torx T6 screwdriver)
- Black stick (or other nonconductive nylon or plastic flat-blade tool)
- Soft cloth to protect the display face

Part Location



Preliminary Steps

Before you begin, remove the following:

- Battery
- Top case
- PC card cage
- Display panel assembly
- Clutch cover (after separating the display rear housing from the LCD/bezel assembly)

Procedure

1. Remove the two screws at the bottom corners of the display bezel.

922-6487



6.1 mm

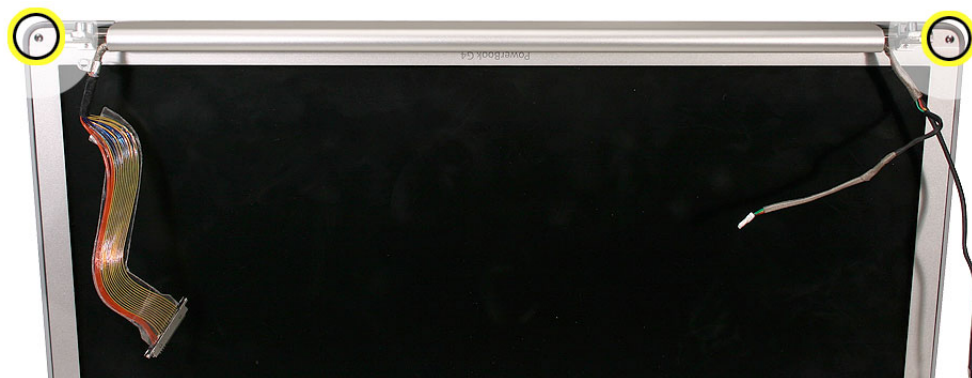

2. Hold the display assembly up on one side and carefully push with your thumbs on the edge bead to disengage the rear housing from three tabs on the side of the bezel.

Note: You will not fully disengage the housing from the bezel at this point.

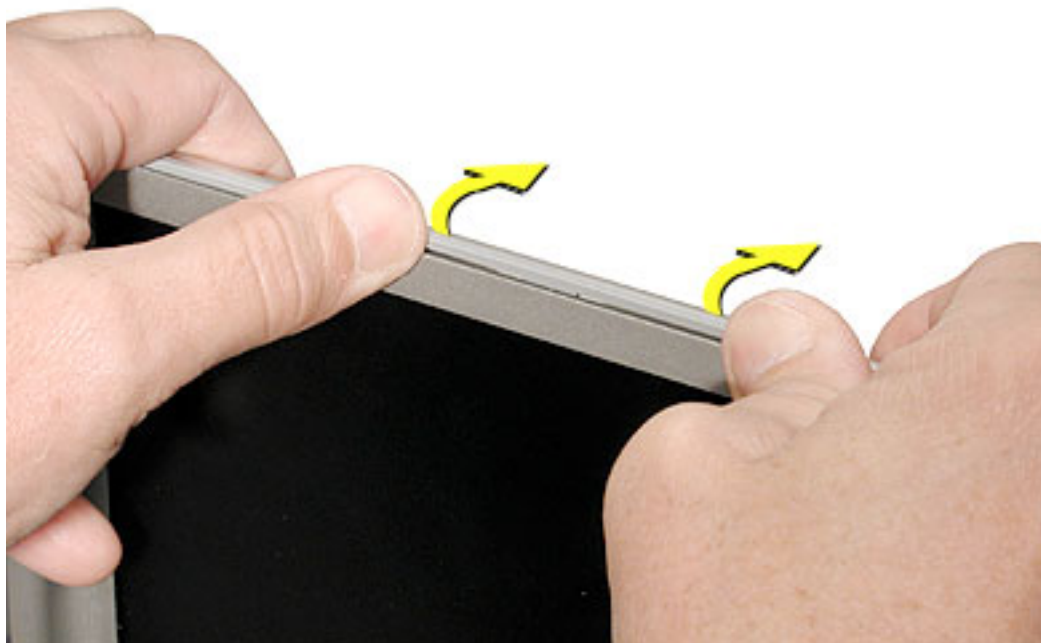

A black stick may also be helpful to disengage the housing from the tabs.

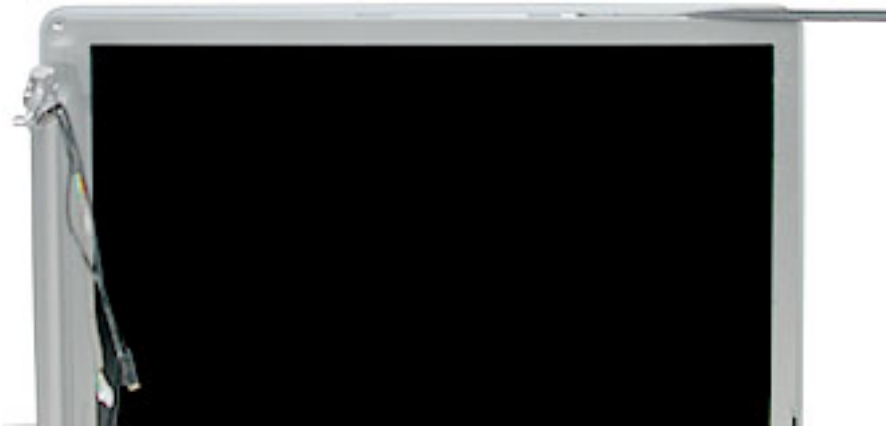

3. Repeat step 2 on the other side of the display.
4. Use a black stick to carefully work around the bottom corners (clutch side).

Important: The grey trim bead is part of the rear housing. Make sure to work the black stick on the correct side of the bead.

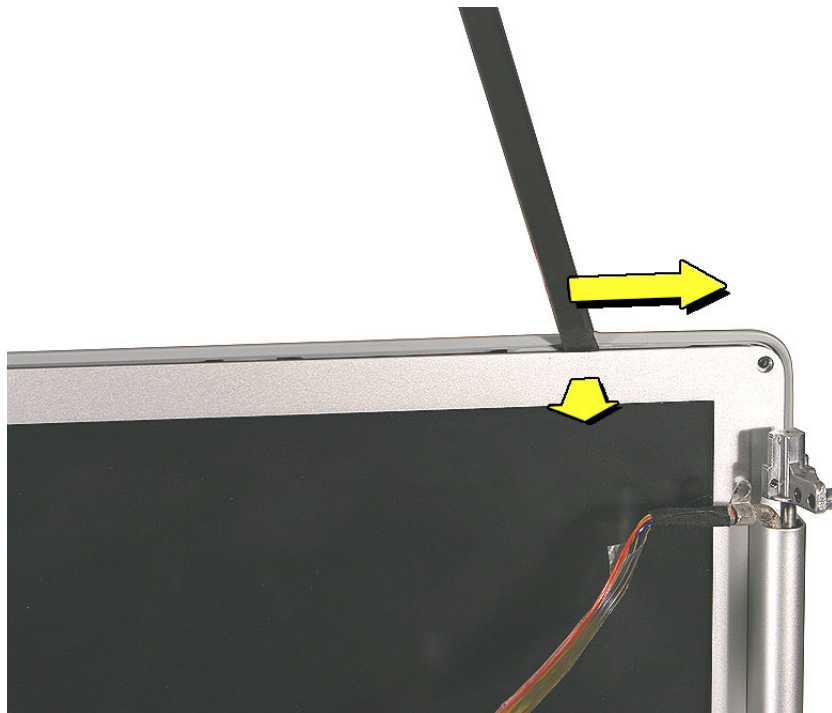

5. To help disengage the clips under the clutch cover, you may need to push down with your thumb over the clip locations on the clutch cover, while carefully disengaging the rear housing.

Important: The grey trim bead that is part of the rear housing continues as an insert along the bottom, where it secures clips under the clutch cover. The material is fragile, so do not use too much force with the black stick. Also, be careful that it does not separate from the rear housing.

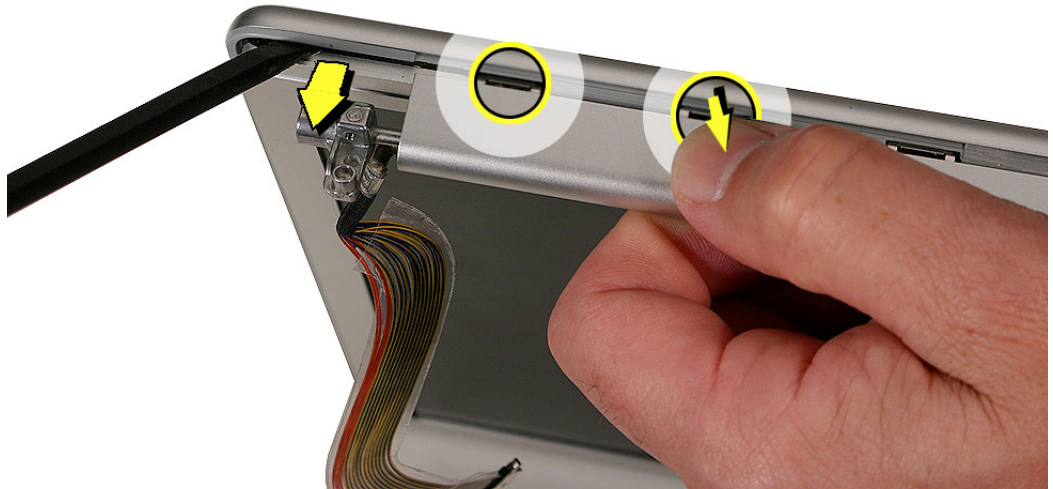

6. When the housing is loosened on sides and bottom, run a black stick along the gap at each bottom corner to slightly separate the rear housing from the display assembly.

Warning: The rear housing is connected to the display assembly with two antenna cables. Do not remove the rear housing or strain the cables. Carefully hold the rear housing and display assembly together to prevent damage.



-
7. Place the display with LCD facing down on a soft clean cloth.
 8. Lift the back of the rear housing up slightly and push it forward slightly to disengage the clips at the top of the housing from the bezel. Be careful not to strain the cables.

Important: Do not separate the rear housing from the display panel assembly. Antenna cables are still connected at the clutch area.



Important: At this point the sleep magnet, display hook assembly, or inverter can be removed without removing the rear housing.

But to do so, you must carefully hold the housing and panel assembly together to avoid unnecessary movement that may cause damage to the display panel or antenna cables.

Otherwise continue with these procedures to remove the rear housing.

- Carefully rotate the display housing open, pivoting along the bottom edge so not to strain the antenna cables, and lay the assemblies side-by-side.

Important: Handle the display assembly by the edges only. Avoid pressure on the back of the display (the white area of the LCD panel).

- Disconnect the antenna jumper couplings, as shown.

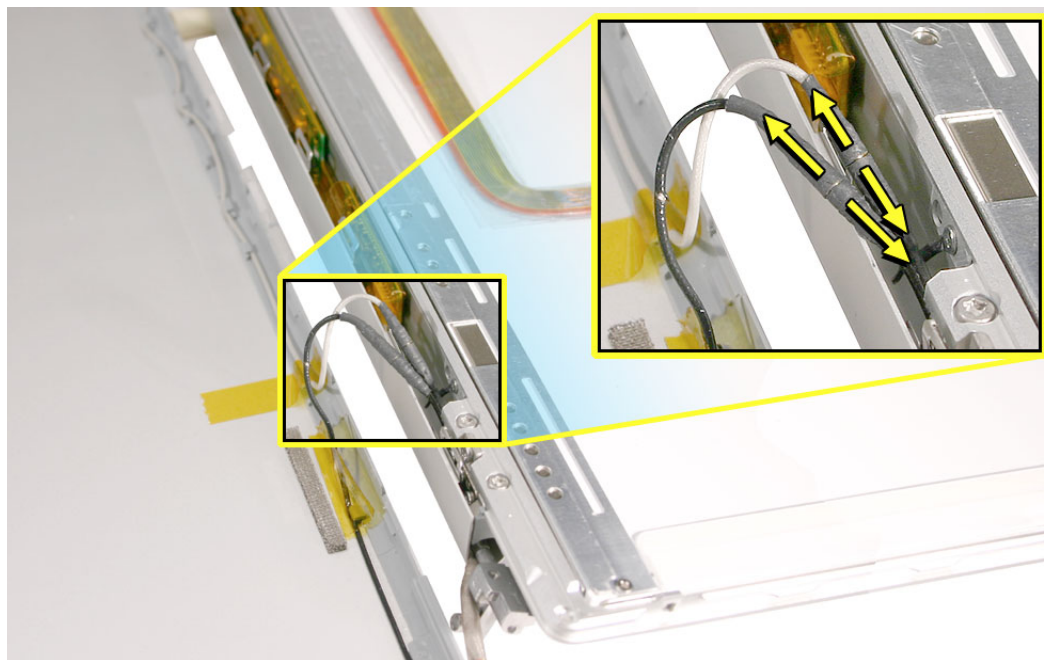

- Remove the rear housing.

Replacement Notes:

- If the replacement housing has the wireless antenna and inverter cable jumper assembly attached, remove it at the couplings, unless replacing. To replace the jumper assembly, the clutch cover must be removed.
- The rear display housing includes the housing, logo, and two antenna cables. Make sure the antenna cables are routed correctly, as shown.
- Before installing, make sure the housing is clean and there are no foreign particles on the inside of the housing, especially around the logo diffuser.

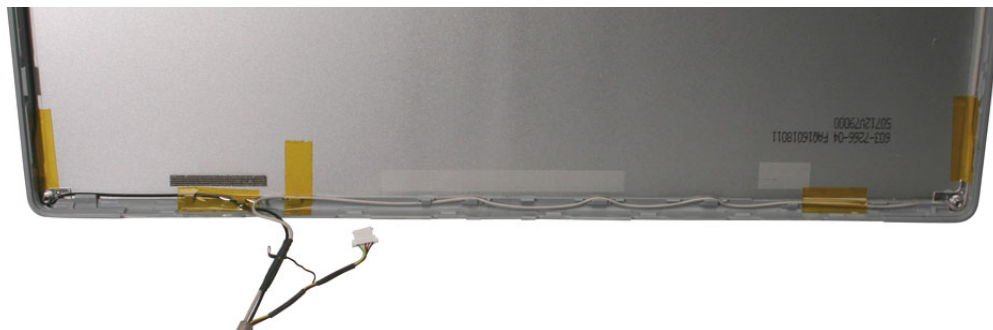

- When installing the rear cover, make sure that the clips on the clutch cover guide under the grey plastic trim on the rear housing.

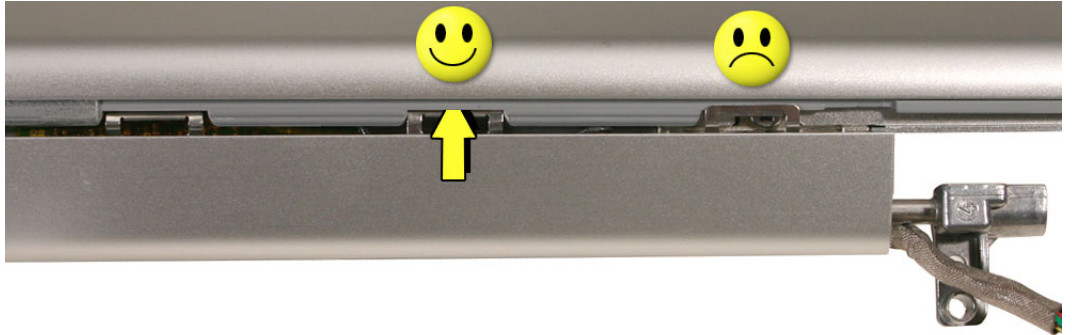

12. Reassemble and test the computer.



Display Hook Assembly

Tools

This procedure requires the following tools:

- #0 Phillips screwdriver (magnetized)
- Soft cloth to protect the display face

Part Location

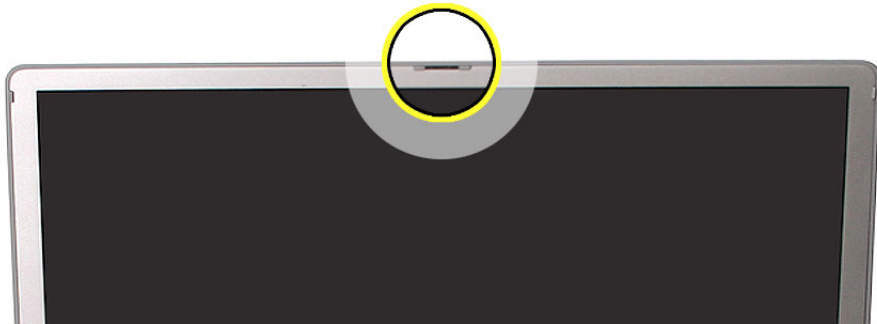

Preliminary Steps

Before you begin, remove the following:

- Battery
- Top case
- PC card cage
- Display panel assembly
- Display rear housing

Procedure

Important Note: Handle the display assembly by the edges only. Avoid pressure on the back of the display (the white area of the LCD panel).

1. Lay the display panel assembly on a soft cloth.

At the top edge of the display assembly, remove the four screws that secure the display hook assembly to the display bezel.

Important: The screws are quite delicate. To avoid stripping the screws, make sure that the screwdriver fits correctly and that steady pressure is applied when removing and reinstalling the screws.



2. **Replacement Note:** To install the replacement hook assembly, press down on the pivot point of the hook to make sure the hook assembly is balanced and stays flat against the display bezel while securing the screws.

Install the replacement hook assembly, and reassemble and test the computer.



Sleep Magnet

Tools

This procedure requires the following tools:

- Needlenose pliers
- Kapton tape
- Soft cloth to protect the display face

Part Location



Preliminary Steps

Before you begin, remove the following:

- Battery
- Top case
- PC card cage
- Display panel assembly
- Display rear housing

Procedure

Important Note: Handle the display assembly by the edges only. Avoid pressure on the back of the display (the white area of the LCD panel).

1. Lay the display assembly on a soft cloth.



2. Grab the magnet with needlenose pliers and remove.



3. Remove the adhesive protector from the replacement magnet and press into place.
4. Put Kapton tape over the magnet to secure. Do not let tape ride up onto bezel.





Inverter Board

Tools

This procedure requires the following tools:

- Black stick (or other nonconductive nylon or plastic flat-blade tool)
- Soft cloth to protect the display face

Part Location



Preliminary Steps

Before you begin, remove the following:

- Battery
- Top case
- PC card cage
- Display panel assembly
- Display rear housing

Procedure

Important Note: Handle the display assembly by the edges only. Avoid pressure on the back of the display (the white area of the LCD panel).

1. Slide a black stick behind the inverter to carefully loosen the adhesive at the back of the inverter board at the locations shown below.



2. Lift up the inverter board.

Important: The inverter board can be damaged if bent. Handle the board carefully to avoid bending the board.



3. Disconnect the inverter cables, shown here, and remove the board.

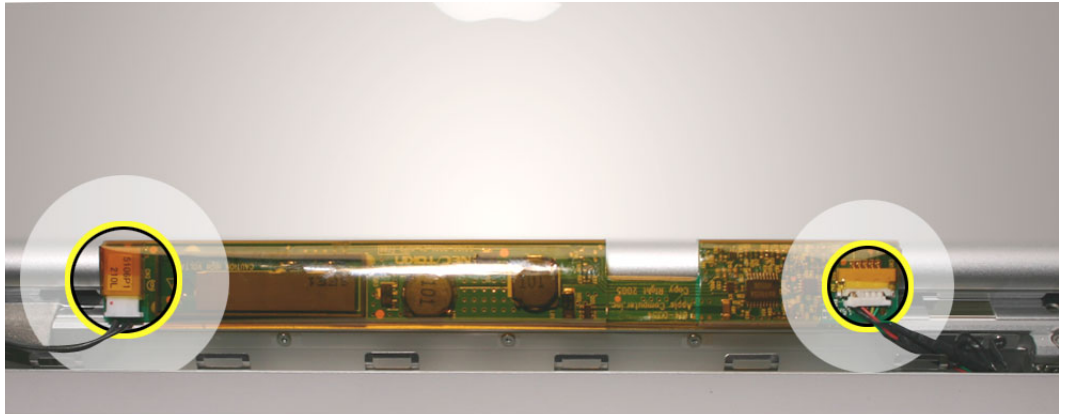

Replacement Note: The replacement inverter board is wrapped in an insulator. Do not unwrap the board. Handle the board carefully to avoid bending.

4. Remove the adhesive protectors from the insulator.



5. Reassemble and test the computer.



Clutch Cover

Tools

This procedure requires the following tools:

- #0 Phillips screwdriver (magnetized)
- Black stick (or other nonconductive nylon or plastic flat-blade tool)
- Soft cloth to protect the display face

Part Location

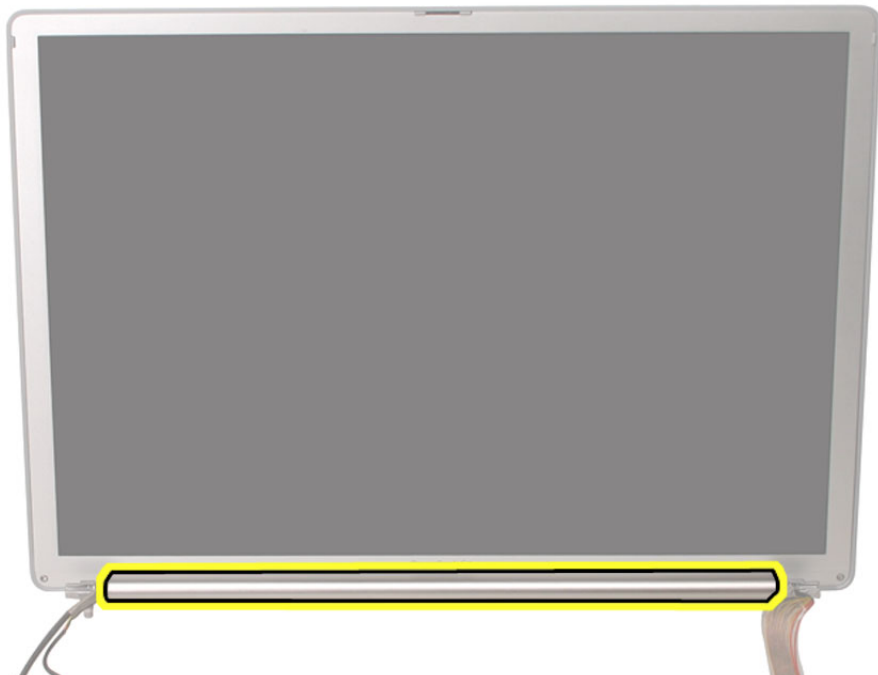

Preliminary Steps

Before you begin, remove the following:

- Battery
- Top case
- PC card cage
- Display panel assembly
- Display rear housing
- Inverter board

Procedure

Important Notes:

- Some photos in the following procedures show the display rear housing. For these procedures the rear housing should be fully removed and set aside.
 - Handle the display assembly by the edges only. Avoid pressure on the back of the display (the white area of the LCD panel).
1. With the display face down on a soft clean cloth, remove the five screws that attach the clutch cover to the bezel.

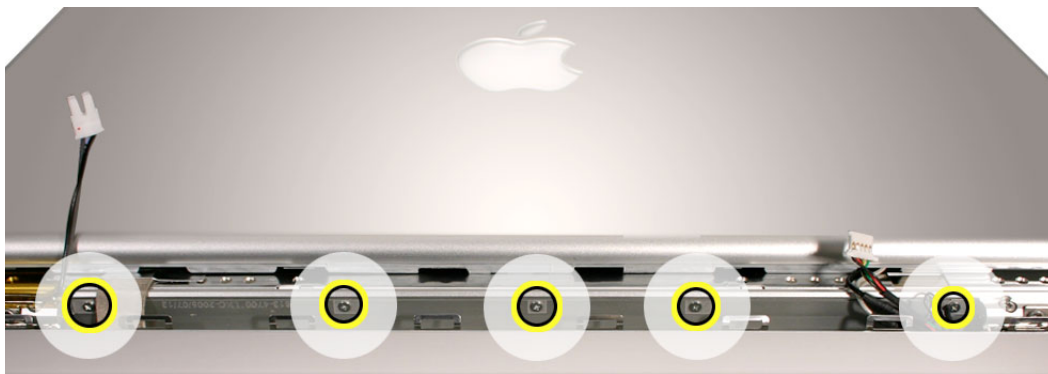

2. **Replacement Note:** Make sure to secure the ground wire of the cable assembly with the screw, as shown.



3. Place the display on its top edge so you can access the clutch cover.

Replacement Note: Notice the orientation of the cables at the ends of the clutch cover. When replacing the clutch cover, make sure the cables are in the same orientation.



4. Starting at one end of the clutch cover, pinch and squeeze the clutch cover with one hand while you use the other hand to press the clutch cover end off of the display assembly.

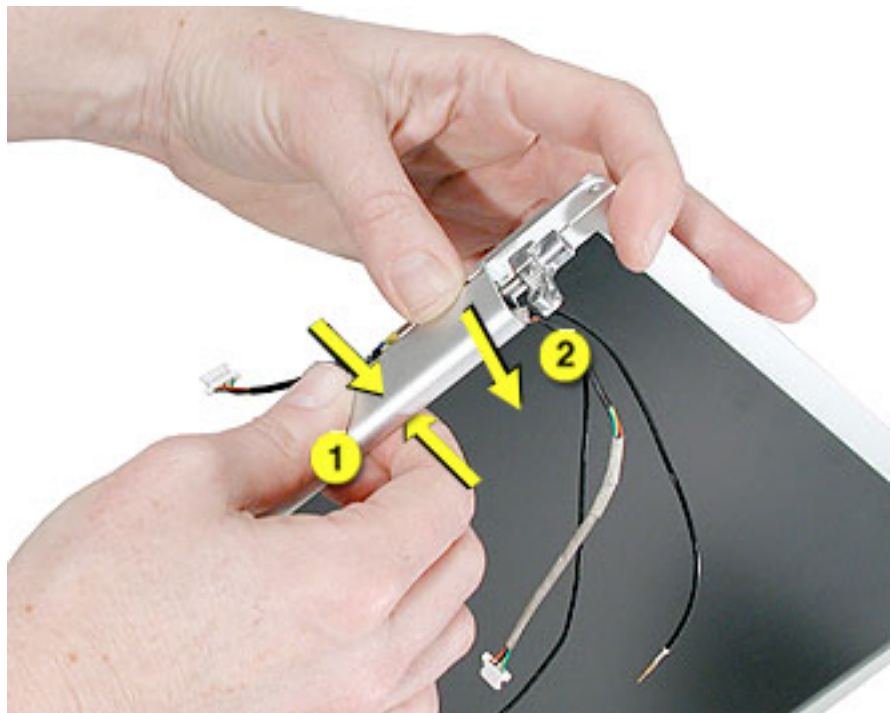

5. Support the assembly as you remove the other end of the clutch cover.
6. Note the routing of the cables around the clutches.
7. The inverter cable and antenna jumper cables assembly can now be removed.

Warning: The clutches on the display bezel are not self-aligning. Do not remove the bezel clutches or their screws (see Display Clutch chapter).

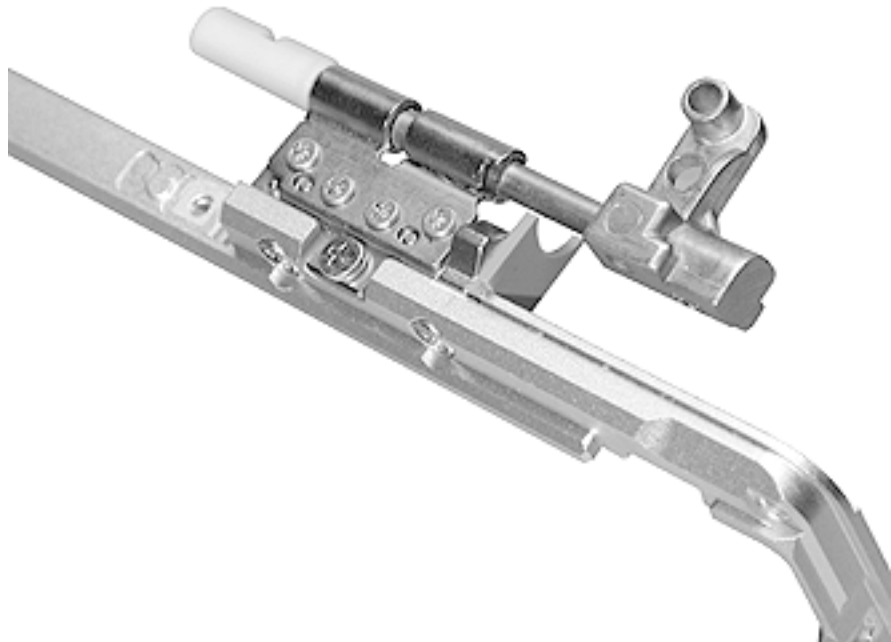

Replacement Notes:

- When installing the clutch cover, make sure the screw hole and the short pin on the bezel align with the holes in the cover.

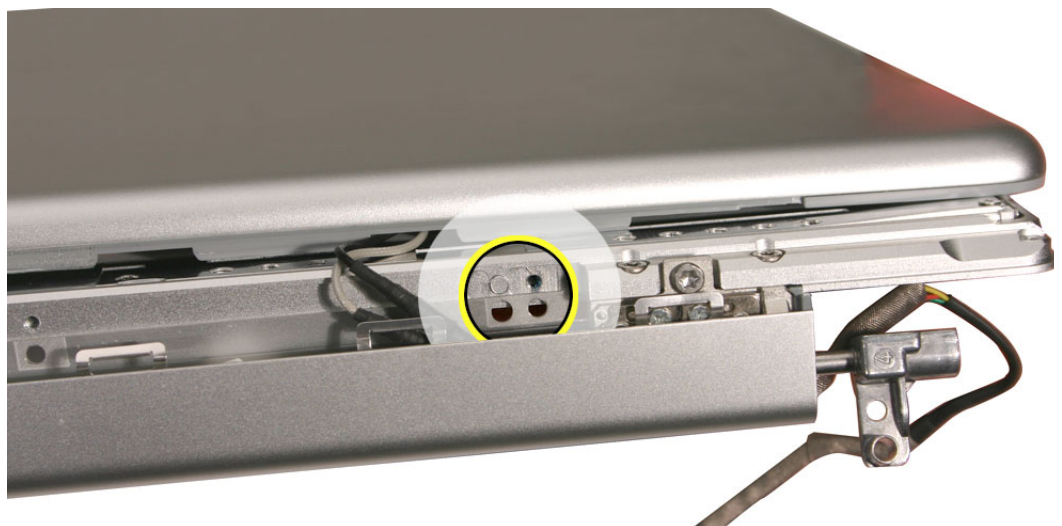

- It may help to use a black stick to push out the clutch cover to allow it to align with the plastic clutch block cover.

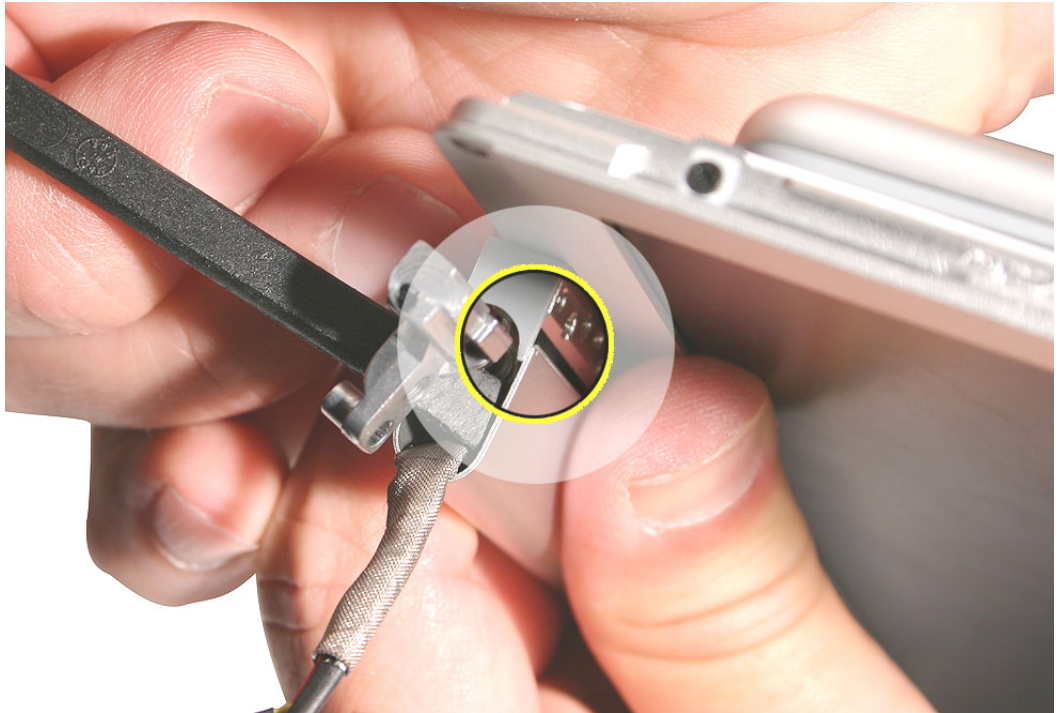

8. Reassemble and test the computer.



LVDS Cable

Tools

This procedure requires the following tools:

- Soft cloth to protect the display face
- Kapton tape
- Black stick (or other nonconductive nylon or plastic flat-blade tool)

Part Location

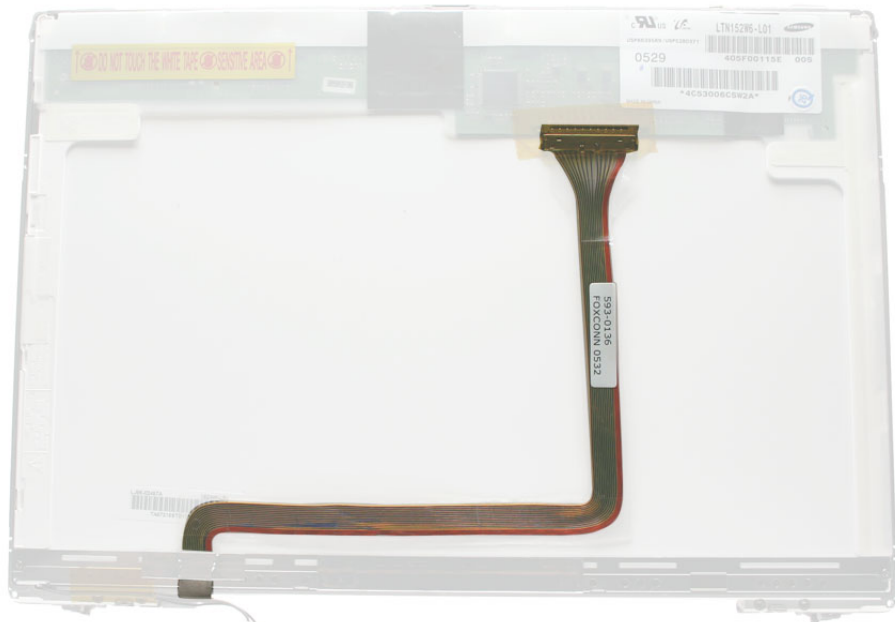

Preliminary Steps

Before you begin, remove the following:

- Battery
- Top case
- PC card cage
- Display panel assembly
- Display rear housing
- Inverter board
- Clutch cover

Procedure

Warning: To avoid damage, pooling, or white spots, handle the display assembly by the edges only. Avoid pressure on the back (white area) of the panel.

1. With the display assembly face down on a soft cloth, peel up the tape from the LVDS connector, and disconnect the cable from the LCD panel.

Important: When reconnecting the LVDS cable, make sure it is fully seated. Secure the cable with one layer of Kapton tape, as shown.



2. Peel up the metal tape securing the clutch end of the LVDS cable and reserve for reinstallation, or install new.



- Note the position of the LVDS cable on the clutch post. It is held in place with adhesive.

Replacement Note: Be sure to position the replacement LVDS cable under the clutch post as shown.

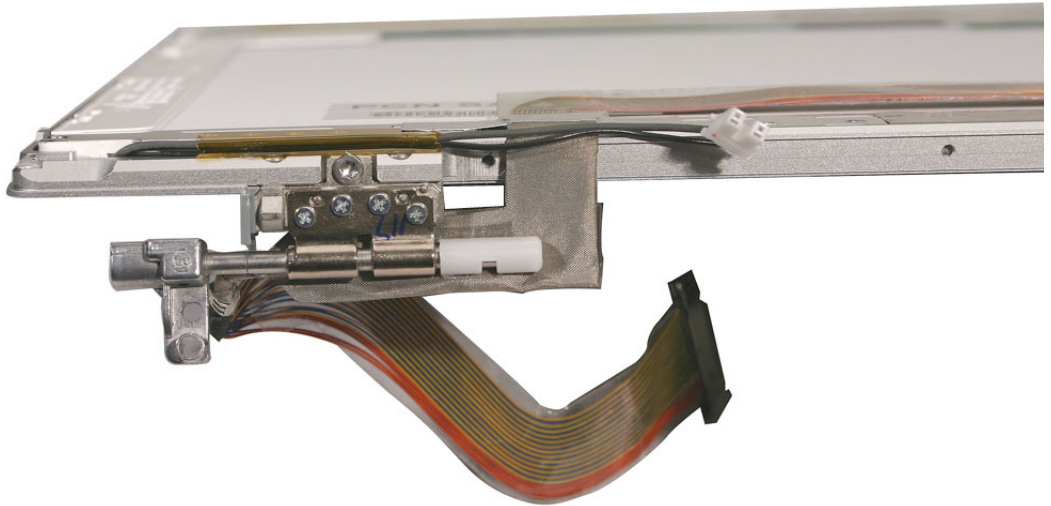

Replacement Note: Remove the protective strip covering the adhesive on the replacement LVDS cable before installing.

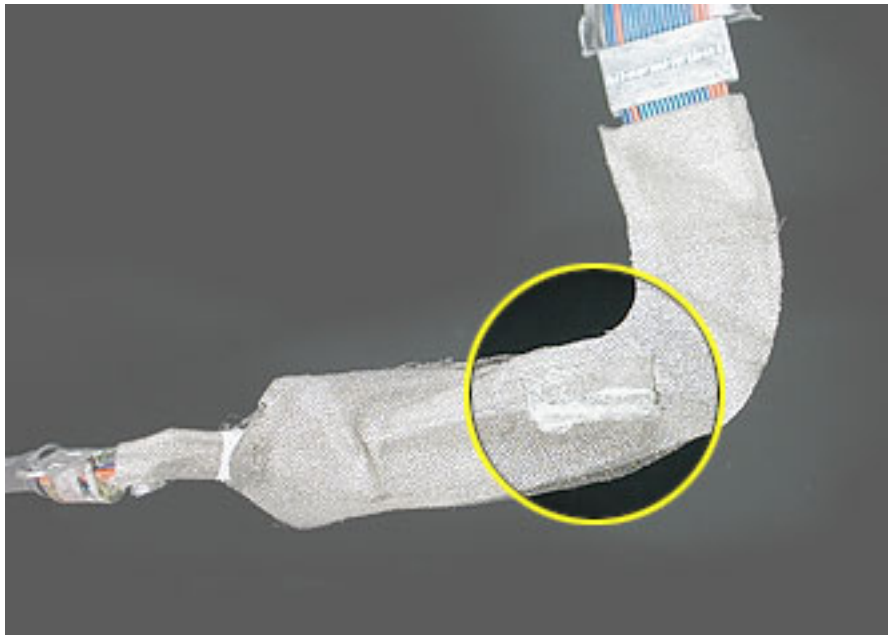

-
4. Remove the LVDS cable from the display assembly.



5. Reassemble and test the computer.



LCD Panel

Tools

This procedure requires the following tools:

- #0 Phillips screwdriver (magnetized)
- Black stick 922-5065 (or other nonconductive nylon or plastic flat-blade tool)
- Isopropyl alcohol wipes (for removing adhesive residue)
- Soft cloth to protect the display face
- LCD Panel Spacer Kit 076-1193 (if not installed/included with replacement LCD panel)
- Bezel Adhesive Strips 922-6733 (if not included with replacement LCD panel)

Part Location



Preliminary Steps

Before you begin, remove the following:

- Battery
- Top case
- PC card cage
- Display panel assembly
- Display rear housing
- Inverter board
- Clutch cover
- Sleep magnet (adhesive attached to LCD)
- LVDS cable

Procedure

Warning: Handle the LCD panel by the edges only. To avoid damage, pooling, or white spots, do not press on the front or back of the LCD panel.

1. Position the display face down on a clean soft cloth.
2. Remove the two screws from both sides of the display.



3. Remove the four screws at the top of the display.



4. Hold the LCD and bezel together and turn it so the LCD faces up.
5. Carefully lift up on the top of the bezel to separate it slightly from the LCD.

Warnings:

- Adhesive holds the bottom of the LCD and bezel together. Do not lift the bezel too far or damage to the LCD frame will result.
- If too much pressure is applied to the bezel, it can be bent out of alignment.

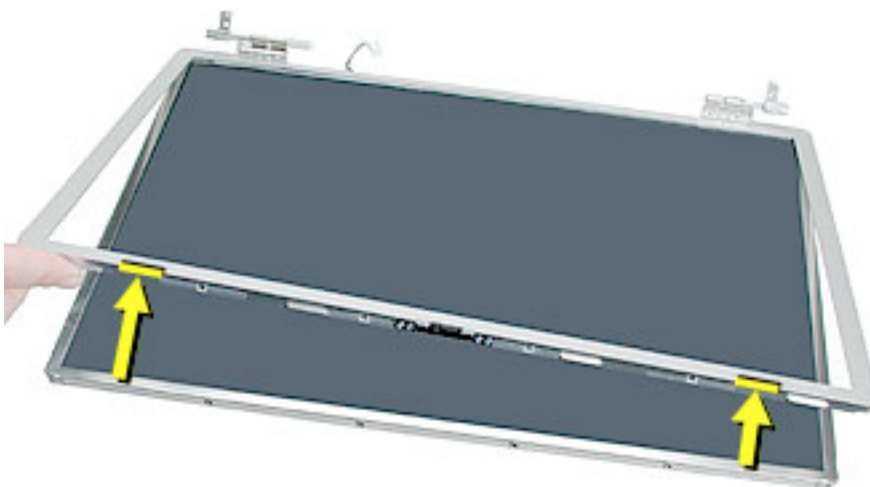

6. Guide a black stick into the gap between the metal LCD frame and the bezel. Carefully move it back and forth, gradually going deeper, to release the adhesive.

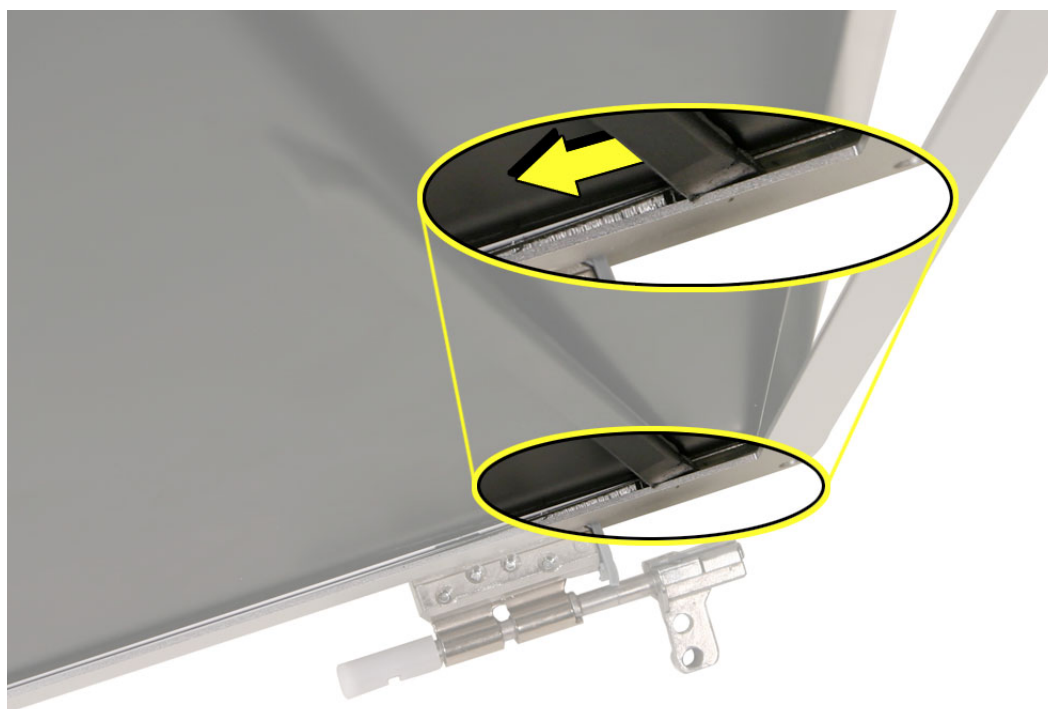

7. Lift the bezel off of the LCD panel.

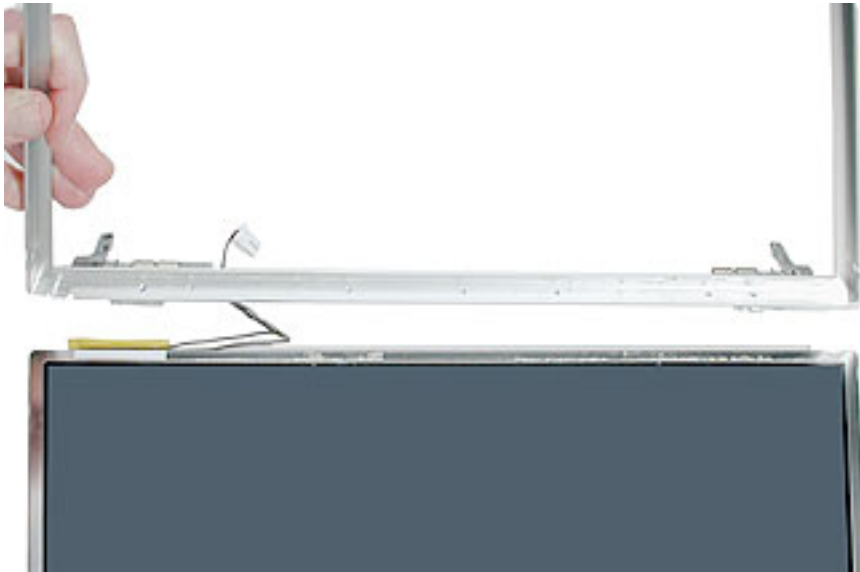

If installing a replacement LCD panel

1. Verify that three spacers are installed. If not, you need to install them—one along each side and one longer one along the top of the LCD panel.

Important:

- Do not install spacers if they are already installed on the LCD panel.
- When installing spacers, be careful to align them properly with the screw holes.



If reinstalling the bezel

1. Use Isopropyl alcohol wipes and a black stick to remove any residual adhesive along the lower inside edge of the bezel. Rub the wipes vigorously over the adhesive and scrape with the black stick. Verify that the adhesive is completely removed so that there are no clumps of adhesive remaining that will create an uneven surface.

Warning: Sharp edges may be present.

2. Install the two replacement adhesive strips along the inside bottom edge. Peel an adhesive strip from its backing, carefully position as shown below, and apply. Remove the protective material over the adhesive strips before installing the LCD.

Important: Do not allow anything to come in contact with the adhesive while positioning. The adhesive sticks to anything it touches, such as fingers, and will pull off its backing and stretch out of shape.

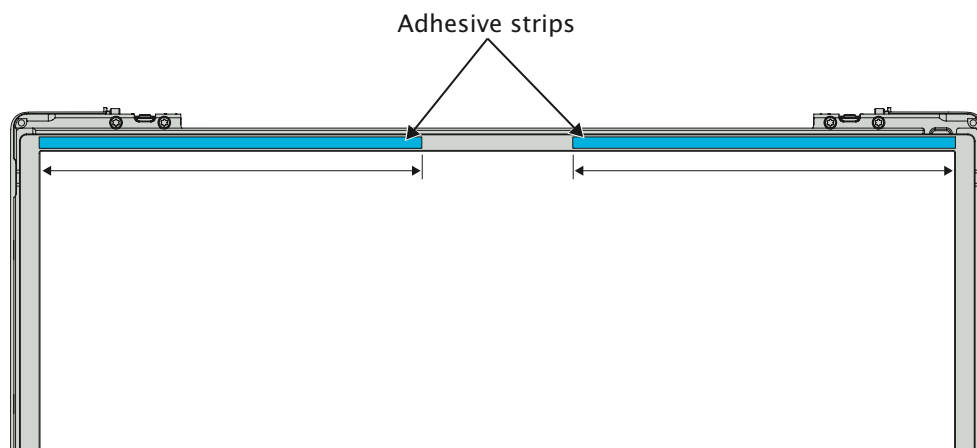

If installing a replacement bezel

1. Remove the protective material over the adhesive before installing the LCD. If adhesive is not present, install as instructed above.

Reassemble and test the computer

Replacement Note: Transfer the sleep magnet to the new LCD panel assembly. Refer to the Sleep Magnet section for correct installation.

After the computer is reassembled, testing should include closing the display while the computer is running to verify that the computer goes to sleep.



Display Bezel

Tools

This procedure requires the following tool:

- Torx T8 screwdriver (if transferring clutches to a replacement bezel)

Part Location

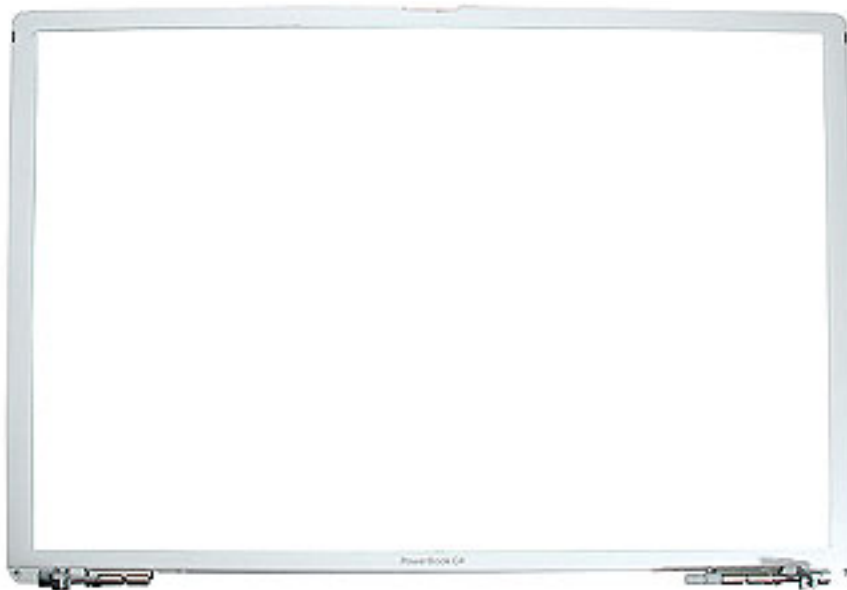

Preliminary Steps

Before you begin, remove the following:

- Battery
- Top case
- PC card cage
- Display panel assembly
- Display rear housing
- Inverter board
- Clutch cover
- Sleep magnet (adhesive attached to LCD)
- LVDS cable
- LCD panel

Procedure

Important: Do not remove or loosen screws on the clutches. The clutches are not self-aligning and even a 0.3 mm shift will be noticeable.

Important: If uneven pressure is applied to the bezel, it can be bent out of alignment. Avoid twisting the bezel.

With all preliminary steps performed, the bezel is the remaining part.

Replacement Procedure

If installing a replacement bezel

1. Remove the clutch block and clutch assembly on the replacement bezel, if present. They may not be aligned for the computer and will not be used.
2. Transfer the clutch blocks with clutches attached, to the replacement bezel, by removing the three T8 screws on each one.

Important: Do not remove or loosen screws on the clutches. The clutches are not self-aligning and even a 0.3 mm shift will be noticeable.

3. Remove the adhesive backing along the bottom inside bezel edge. If adhesive is not present, follow the procedure in the LCD chapter to install.

If reinstalling the bezel

1. Follow the procedure in the LCD chapter to remove the residual adhesive, and to install new adhesive.

To install the bezel

1. Place the bezel face down on a table with the clutches positioned over the edge.



Important:

- If installing a replacement LCD panel, verify that three spacers are installed (see LCD Panel chapter).
 - Handle the LCD panel by the edges only. Avoid pressure on the back of the panel (the white area of the LCD panel).
2. Holding the sides of the LCD panel and the sides of the bezel, carefully align the LCD panel over the inner edges of the bezel.



3. Lower the LCD panel and press its outside edges and the bezel into place.
4. Reassemble and test the computer.



Display Clutch

Tools

This procedure requires the following tools:

- #0 Phillips screwdriver (magnetized).
- Torx T8 screwdriver (if transferring to a replacement bezel)

Part Location

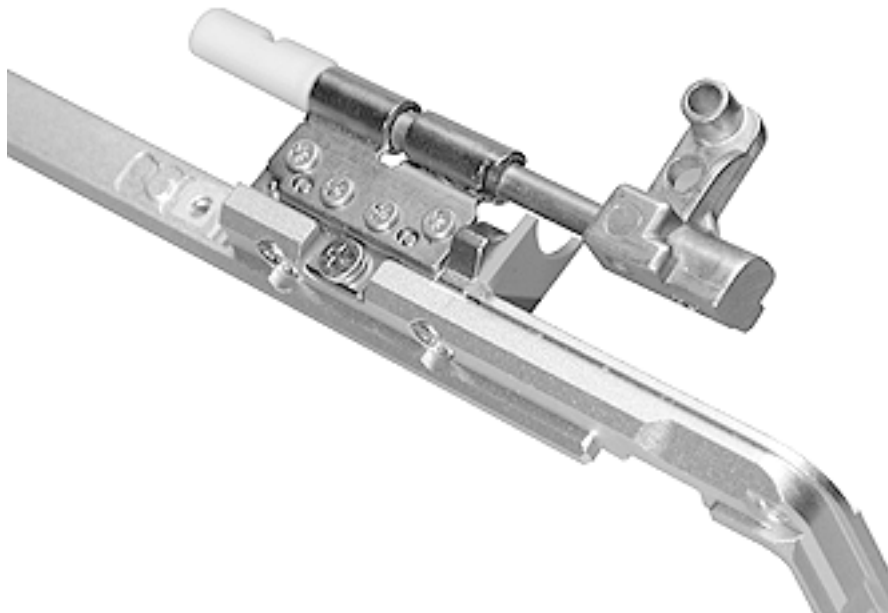

Preliminary Steps

Before you begin, remove the following:

- Battery
- Top case
- Display panel assembly
- Display rear housing
- Inverter board
- Clutch cover

Procedure

Important: Do not remove or loosen screws on the clutches, except in the manner described below. The clutches are not self-aligning and even a 0.3 mm shift will be noticeable.

Important: If too much pressure is applied to the bezel, it can be bent out of alignment. Avoid flexing the bezel.

If transferring clutches to a replacement bezel

Important: Do not remove or loosen screws on the clutches.

1. Remove the two clutch blocks (if installed) on the replacement bezel by removing the three T8 screws that secure each one. These will not be used.
2. Remove the corresponding three screws for each clutch block on the bezel being replaced, and transfer them with the clutches intact to the replacement bezel.

If replacing clutches

Important: To maintain factory alignment, remove and replace only one clutch at a time. Do not touch the screws of the other clutch, so that it maintains its alignment position from the factory.

When the replacement clutch is installed, place the display back into the bottom case and secure the clutch that was not removed. Check the replaced clutch for alignment. If needed, remove the display, adjust the installed clutch, and repeat until properly aligned.

Repeat this procedure for the other clutch, if replacing.

1. Remove the four screws from the display clutch.

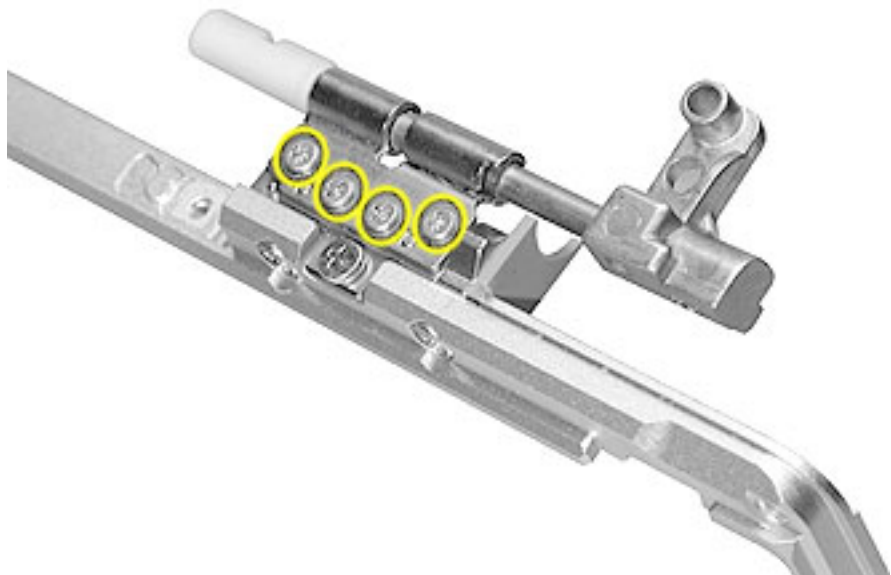

2. When installing the replacement clutch, be sure all openings align with the pins or holes on the shim and bezel.
3. Hold the clutch firmly against the bezel when installing the screws.

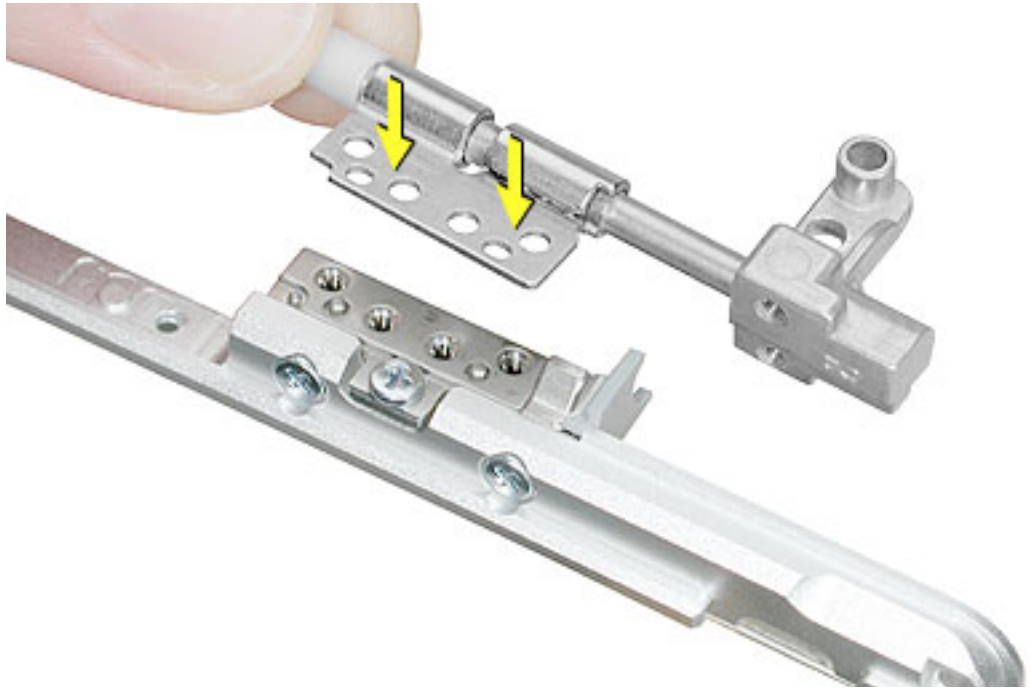

4. Reassemble and test the computer.



Troubleshooting

PowerBook G4 (15-inch Double-Layer SD)



General Information

Wire and Flex Cables

With the very thin enclosure design and dispersed circuit board, a large number of flex cables are used in this computer. In addition, there are a variety of wire cable harnesses as well. Many of these cables carry multiple types of signals.

Here is a list of the cables and the signals that run across them. If you notice a group of functions not working, it is likely that the cable is not properly inserted or the connector is damaged.

Cable or Flex Cable Name	Signal(s) Running Through It
Bluetooth antenna cable (to AirPort Extreme w/ Bluetooth card)	Bluetooth radio signal
AirPort Extreme antenna cable (to AirPort Extreme w/ Bluetooth card)	AirPort radio signal
AirPort Extreme/Bluetooth 2.0 Flex (to logic board)	AirPort/Bluetooth data / power
Ambient Light Sensor (Left) cable	Light data from left side
Blower, left cable (to logic board)	Power/control for left blower
Blower, right cable (to logic board)	Power/control for right blower
Hard drive flex (to logic board)	Hard drive control (cable select info), data, and power
Inverter cable (from display panel)	High voltage for backlight
Inverter/antenna cable (to logic board and AirPort Extreme w/ Bluetooth card)	Display backlight control AirPort radio signal Bluetooth radio signal
Keyboard backlight cable (on top case)	Power to keyboard backlight LEDs
Keyboard flex (from keyboard to trackpad)	Keyboard data and status lines
LVDS cable (from display housing)	Video data to display panel
Main battery cable	Connects main battery to logic board

Cable or Flex Cable Name	Signal(s) Running Through It
Modem flex (to logic board)	Modem control and data
SuperDrive flex (to logic board)	SuperDrive data, power, and control signals (cable select info)
PC Card cage flex (to logic board)	PC card data and power
Power Button cable	Power-on signal
RJ-11 cable (to modem)	Analog phone signal
Right USB flex	Right USB data and power
Sleep LED cable (to logic board)	Power to sleep LED
Sound/DC-in board flex (to logic board)	Left USB connector Left ambient light sensor Digital audio in/out
Sound/DC-in board cable harness (to logic board)	Power to system and main battery
Main speaker-cable assembly	Left speaker audio Right speaker audio Internal microphone audio
*Left speaker assembly wire harness	Left speaker audio Internal microphone audio
Right speaker assembly wire harness	Right speaker audio
Trackpad flex (to logic board)	Trackpad data and power Power on button Keyboard backlight power Sleep sense signal Keyboard data

*The following diagram of the left speaker assembly and wire harness is for reference only, but can be used to check the speaker and microphone wiring.

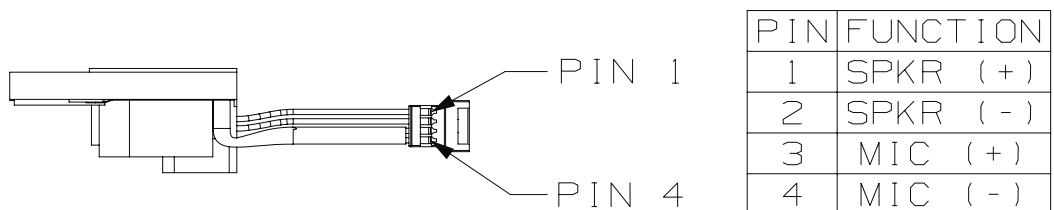

Hardware Troubleshooting Tools and Tips

Apple Hardware Test (AHT) 2.5.2

Notes:

- AHT 2.5.2 is backwards compatible.
- Starting with Apple Hardware Test 2.5.2, the customer must first select a language.
- Starting with the PowerBook G4 (17-inch), the Apple Hardware Test software will be incorporated into the Software Install and Restore DVD. There is no separate CD for this diagnostic.
- Currently, the test image is now posted on Service Source online.
- Apple Hardware Test 2.0.1 and later is not backward compatible with PowerBook computers prior to the PowerBook G4 (1GHz/867MHz).

Previously, the C key was held down to boot into the diagnostics. With the combined DVD, this action will boot into the software restore section of the disk. In order to access the AHT on the DVD follow these steps:

1. Insert the DVD named “PowerBook G4 15-inch and 17-inch Software Install and Restore” that came with your computer.
2. Hold down the Option key and restart the computer.
3. Click Apple Hardware Test volume in the startup manager.

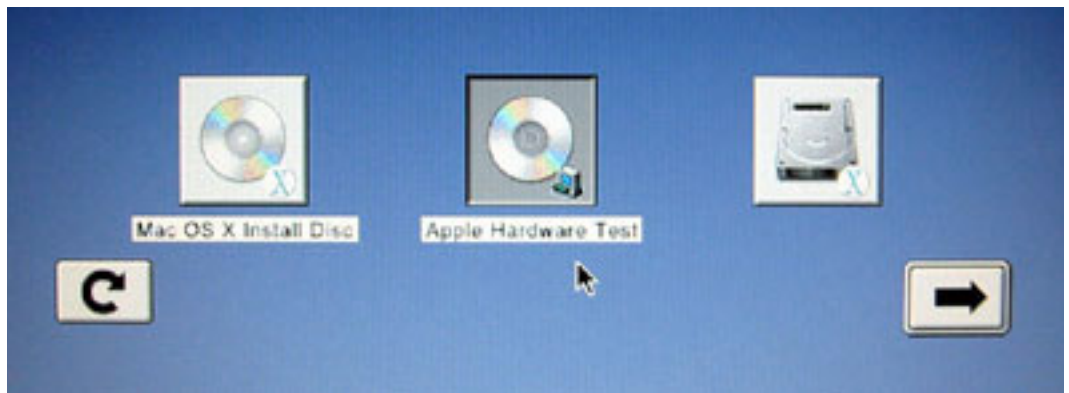

4. Click the arrow that points to the right.
5. Follow the on-screen instructions.

Apple Service Diagnostic (ASD) 2.6.3

MacTest Pro software does not work on this computer since the PowerBook G4 (15-inch FW 800) and forward are Mac OS X only systems. ASD is the replacement and can be downloaded from Knowledge Base article 112125: Service Diagnostics Matrix.

Important: ASD 2.6.3 is backwards compatible to the PowerBook G4 (1GHz/867MHz) and later.

Apple Service Diagnostic Main screen:

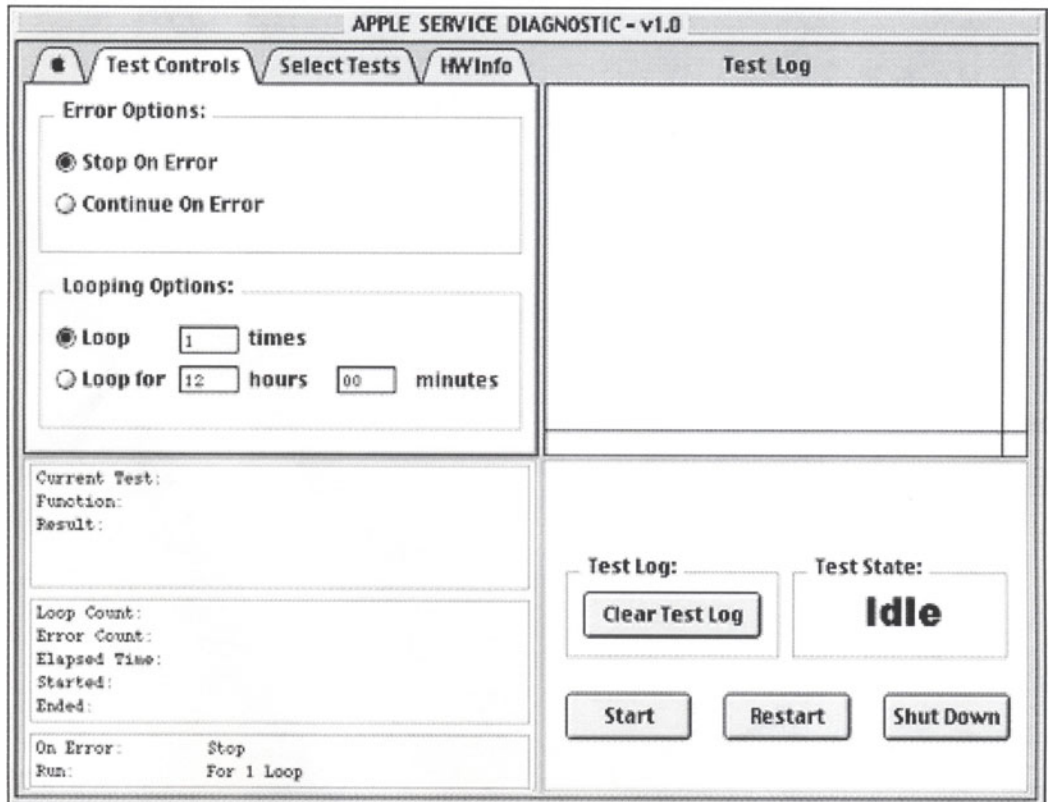

Apple Service Diagnostic Select Tests tab:

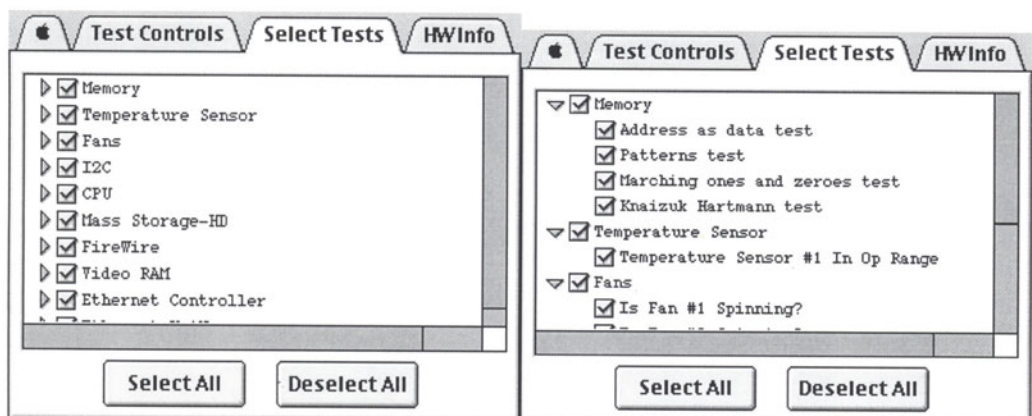

Apple Service Diagnostic Hardware Info tab:

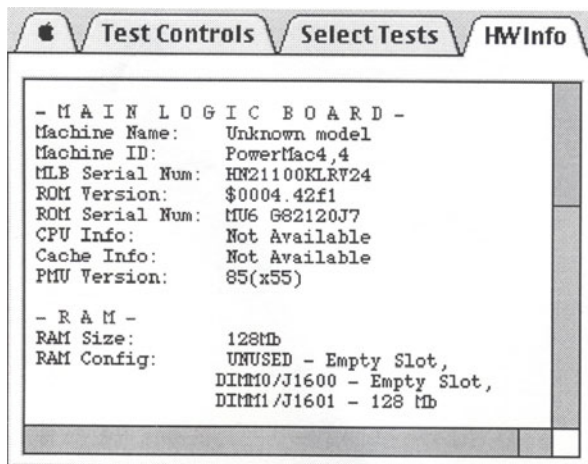

Apple Service Diagnostic Test Log tab:

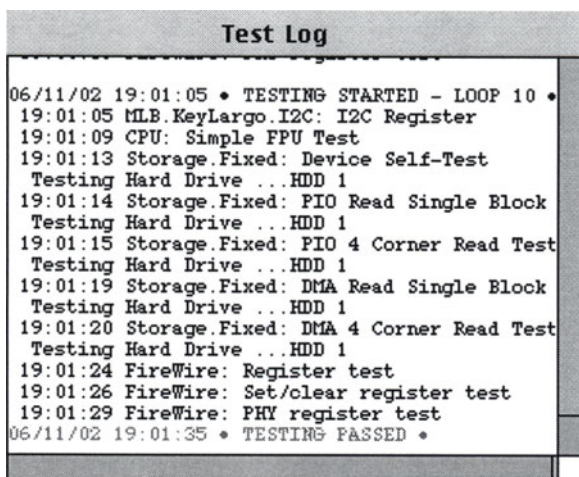

Power Button pads on logic board

With the top case removed, the power button is disconnected. Instead of having to reconnect the top case to turn on the system, there are two pads on the logic board that can be shorted across (with a tool like a flat blade screwdriver) to act as the power button.

These pads are located near the edge of the logic board, just above center of the hard drive. It is marked POWER BUTTON. The pads are separated with a vertical white line.

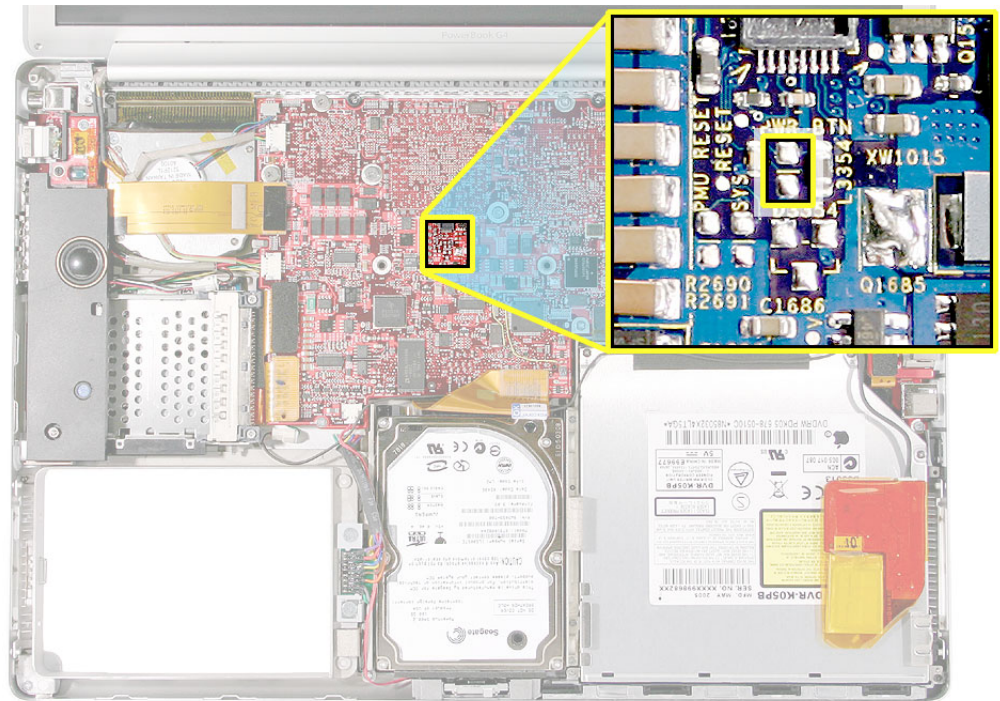

Resetting the Power Manager Unit (PMU)

The PMU reset key sequence has been changed. Use the following procedure or the PMU Reset pad (see PMU RESET pads on logic board, below).

1. If the computer is on, turn it off.
2. Disconnect the power adapter and remove the main battery.
3. Hold the power button down for five seconds, then release.
4. Install the main battery and connect the power adapter.
5. Press the power button to restart the computer.

PMU RESET pads on logic board

In addition to the power button pads on the logic board, there are pads for PMU RESET, which work when their pads are shorted together (with a tool like a flat blade screwdriver). The pads are separated with a white horizontal line between the pads.

The pads are located near the edge of the logic board, just above center of the hard drive.

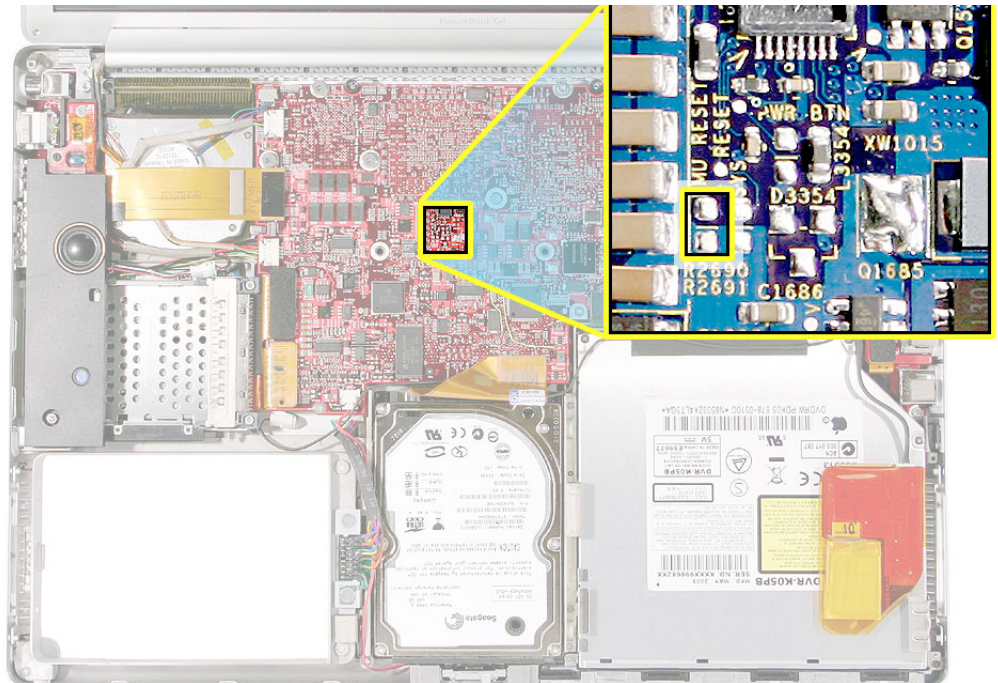

Sleep indicator — Solid light during booting

Starting with the PowerBook G4 Double-Layer SD models, the sleep indicator light in the lid button has a new behavior during startup.

When you first turn the PowerBook G4 on, the sleep indicator will turn on. As the computer starts up, the indicator stays on until the display turns on. This light can be used as a diagnostic to determine at startup whether the main logic board is getting power.

This new indicator will help troubleshoot "dead unit" issues versus "no video" issues:

If you see the sleep light turn on at startup but you see no video, it is likely that the power system is not the issue. The focus of your troubleshooting should be on the video system.

If you see the sleep light turn on, stay on, and not turn off, try booting in Safe Mode off a bootable disc. The computer may be hanging before the video goes on. This situation may occur if the software is corrupted or the hard drive is not responding.

If the issue persists when started up to a valid bootable disc, there may be a hardware issue. If the sleep light never turns on at startup and there is no audible boot chime or drive noise, proceed with troubleshooting the hardware.

Caps lock LED power check (partial)

There are situations when the system is giving indications that it is shut down (no sleep light, no hard drive access, screen is dark, no blower, and so on). However, the logic board may still be running. In this case, the logic board is drawing power and generating heat.

Warning: In this situation, if the computer is put in an enclosed environment like a carrying bag, the computer can overheat.

Check this situation by pressing the caps lock key. If the LED glows, the PMU is running on the logic board. After pressing the caps lock key and perhaps other methods of waking it up fails, including closing the lid to go to sleep and try waking again, hold the power button down for six seconds to force a shut down of the computer. Restart the system to check if it boots up normally.

Note: Previously when the keyboard was connected directly to the power manager this method worked under all conditions, however as a USB device, the OS may be hung and the keyboard cannot respond. So if the caps lock light does not come on, the computer may be drawing power. If in doubt, hold the power button down for six seconds to force a shut down of the computer.

Software Troubleshooting Tips and Tools

Mac OS X only

Starting with the PowerBook G4 (17-inch), the system will no longer boot into Mac OS 9. Mac OS 9 applications can still be used, but only in the Mac OS X classic mode.

In locations such as the Startup Disk system preference pane, a Mac OS 9 folder will not show up as an option.

Login window and account

Mac OS X requires at least one user account to be established. This is the Administrator's account. By default, the Accounts system preference pane has the "Log in automatically [Admin's name]" check. This automatic login setting allows the system to boot into the Finder without having a log-in prompt.

However, if this box is not checked, you will need a password to get to the Finder. In addition, you will need to create a user account after you re-install system software.

Customer forgot password

If the customer forgot the password for the computer:

1. Insert the Software Install and Restore DVD.
2. Restart the computer while holding down the C key on the keyboard.

-
3. When the installer appears, chose Reset Password from the Installer menu
 4. Follow the on-screen instructions.

Safe Mode

The Mac OS X that shipped since the PowerBook G4 (15-inch FW 800), has a new startup state called Safe Mode.

Safe Mode is the state Mac OS X is in after a Safe Boot. A Safe Boot is a special way to start Mac OS X when troubleshooting. Starting up into Safe Mode does three things to simplify the startup and operation of your computer:

1. It forces a directory check of the startup (boot) volume. It is identical to using Disk Utility's Repair Disk or the `fsck -fy` terminal command.
2. It loads only required kernel extensions (some of the items in `/System/Library/Extensions`).
3. It runs only Apple-installed startup items (some of the items in `/Library/Startup Items` and `/System/Library/Startup items` - and different than login items).

Taken together, these changes can work around issues caused by software or directory damage on the startup volume.

To start up into Safe Mode (to Safe Boot), do this:

1. Be sure the computer is shut down.
2. Press the power button.
3. Immediately after you hear the startup tone, press and hold the Shift key.

Note: The Shift key should be held as soon as possible after the startup tone but not before.

4. Release the Shift key when you see the screen the gray Apple and progress indicator (looks like a spinning gear).

During the startup, you will see "Safe Boot" on the Mac OS X startup screen (shown below). To leave Safe Mode, restart the computer normally, without holding any keys during startup.



Knowledge Base Articles

These troubleshooting articles can be searched from <http://www.apple.com/support>.

106692 Mac OS X: Troubleshooting Installation and Software Updates

106693 Mac OS X: Troubleshooting Installation From CD-ROM



Hardware Symptom Charts

How to Use the Symptom Charts

The Symptom Charts included in this chapter will help you diagnose specific symptoms related to the product.

The steps to solve a symptom are listed sequentially. You might not need to perform every step before the symptom is solved. Start with the first step, and then test for the symptom. If the symptom persists, replace any modules you removed, go to the next step, and test again. Continue down the list until the symptom is solved.

Power Adapter Note

The system was designed to use the Apple 65-Watt Portable Power Adapter that came with your computer. The previous 45-Watt Apple power adapter for PowerBooks is plug compatible, but it may not provide sufficient power during some activities and power may be drawn temporarily from the battery. You can identify the Apple 65W Power Adapter by its markings (see photo).



Under low battery or no battery situations, the 45 watt power adapter may not be able to provide enough power to properly support the system.

Startup

The computer will not power on (no blower movement, hard drive spin up and display is not lit)

1. Remove any connected peripherals and eject any PC card.
2. Check that the battery has enough charge to start the computer by pressing the button next to the LEDs on the battery. At least one LED must light solid (not flashing).
3. Connect a known-good Apple 65W Portable Power Adapter and power cord or plug to a known-good power outlet; make sure the DC plug is firmly inserted. The DC plug should light up, if not, replace Sound/DC-in board.

Important: The Apple 65W Portable Power Adapter is highly recommended to be used with the PowerBook G4 (15-inch FW 800) or later computer. The adapters can be identified by 65W in the name and markings, and the metal securing-stud on the plug connector. Although previous 45W power adapters (see Knowledge Base article 88231 PowerBook and iBook: Apple Power Adapter) are plug compatible with the PowerBook G4 (15-inch FW 800) or later, it may not provide sufficient power during some activities and power may be drawn temporarily from the battery.

4. Try powering up without the battery installed (only works with 65W power adapter). If it boots, replace battery connector cable.
5. Reset the power manager. See new procedures under the “Resetting the Power Manager Unit (PMU)” heading in the Hardware Troubleshooting Tools and Tips section.

Warning: Resetting the power manager will permanently remove a RAM disk, if present, and all of its contents. You will also need to reset the date and time (using the Date & Time system preference pane).

6. Boot up the system and check the sleep indicator. If it turns on solid and turns off, the main logic board is getting power and completing the boot cycle. If no video appears, there is an issue turning the video turn-on or system software is corrupted. Try booting off the DVD. If the light does not turn off, the boot cycle is not being complete. This may be cause by the hard drive not being seen by the system, system software corrupted or possibly a hardware issue.
7. Press Caps Lock key to see if key light comes on. If it does, hold power button down for six seconds to shut down the computer and restart.
8. If it still doesn't start, verify power button cable is connected properly to top case flex cable assembly and that the flex cable is connected correctly to the logic board, if power button is not functioning correctly or damaged, replace the top case.
9. Disconnect keyboard completely. Inspect connectors. Restart with keyboard disconnected.
10. Remove any additional RAM.

-
11. Try disconnecting the AirPort Extreme flex connector from the logic board and start the computer. If it starts, shut it down and check the flex cable connector and the connector on the logic board and replace the damaged parts.
 12. Reseat these flex cables:
 - Sound/DC-in flex cable
 - Hard drive flex cable (will boot to flashing folder)
 - Optical drive flex cable
 - PC card cage flex cable
 - Trackpad flex cable
 - Right USB flex cable
 - Modem flex cable

If the computer starts up, inspect the flex cable connector and its connector on the logic board for damage and replace the damaged parts.
 13. Remove AirPort Extreme Card.
 14. Try known-good Sound/DC-in board.
 15. Replace logic board.

Memory error message “The built-in memory test has detected an error” appears on the screen

1. Run Apple Service Diagnostic Test. Note: If the failure is intermittent, run Apple Service Diagnostic Test in loop mode (check looping options under Test Controls tab and select only the RAM test under the Select Tests tab) for an extended time to test the memory.
2. If the test can't find the memory or finds bad memory, inspect the bad DIMM. Verify proper memory is being used. The PowerBook G4 (15-inch Double-Layer SD) uses PC4200 DDR2 SDRAM SO-DIMMs, with a maximum height of 1.25-inch (30 mm). These modules are keyed differently than previous PowerBook G4 1.25-inch RAM. If improper memory is being used replace it. Otherwise, try reseating the DIMM and retest. If still reported as bad, replace it.
3. Check the memory connector for damage (retention arms broken, connectors bent or missing, connector lifted from logic board). If damage is detected replace the logic board.

**Blue screen appears (a spinning disc cursor may also be visible),
Prohibitory Sign appears,
Restart dialog box appears (Mac OS X 10.2 kernel panic window), or
Gray screen during startup**



Prohibitory Sign

You need to restart your computer. Hold down the Power button for several seconds or press the Restart button.

Veillez redémarrer votre ordinateur. Maintenez la touche de démarrage enfoncée pendant plusieurs secondes ou bien appuyez sur le bouton de réinitialisation.

Sie müssen Ihren Computer neu starten. Halten Sie dazu die Einschalttaste einige Sekunden gedrückt oder drücken Sie die Neustart-Taste.

コンピュータを再起動する必要があります。パワーボタンを数秒間押し続けるか、リセットボタンを押してください。

Kernel Panic dialog box

1. Make sure all external devices are disconnected and any PC card ejected. If kernel panic goes away, troubleshoot the external device by reconnecting each device until the panic occurs.
2. If there are two RAM cards installed in the expansion slots, remove the top card and restart.
 - If symptom repeats, replace bottom card with known-good RAM card.
 - If symptom does not repeat, replace top RAM card with known-good RAM card and restart.

For assistance in software troubleshooting, go to Knowledge Base article 106464: Mac OS X: Troubleshooting a Startup Issue.

Flashing question mark appears on the screen

Note: This system will only boot the Mac OS X system that shipped with this computer or later. It does not support booting into Mac OS 9.

1. Start up from the software install and restore DVD that came with the computer (hold down the "C" key during restart).
2. When the Installer opens, from the Installer menu, select Open Disk Utility.
3. When the Disk Utility opens, on the left hand side, all disk and volumes are listed. If you don't see the internal hard drive, the system is not recognizing it. Skip to step 4. Otherwise, select the First Aid tab and follow the instructions to verify the hard disk, and repair if needed. Restart the computer.
4. If the hard drive is not recognized, check the hard drive flex cable for damaged connectors (connector peeled off the flex cable, for example), and if bad replace the hard drive flex cable.
5. Reseat the hard drive flex cable. If still not recognized, replace the hard drive.

Important: If the computer is under warranty and data recovery is required, refer to Knowledge Base article 31077: DriveSavers: Hard Drive Data Recovery & Warranty Implications, for important information.

6. Reinstall system software using the software install and restore disc.

Note: Don't forget to install both the Mac OS X and Applications and Classic software. This operation is completed with two separate installs. Restore disc images are available at <http://service.info.apple.com>. Select "Disc Images."

Computer begins to power up, the blowers and hard drive are spinning, pressing caps lock key and LED turns on, but there is no startup chime or video

1. Reset the power manager. See new procedures under the "Resetting the Power Manager Unit (PMU)" heading in the Hardware Troubleshooting Tools and Tips section.

Warning: Resetting the power manager will permanently remove a RAM disk, if present, and all of its contents. You will also need to reset the date and time (using the Date & Time system preferences pane).

2. Check all cable and flex connections to the logic board. Try restarting.
3. Replace the logic board.

System shuts down intermittently

Important: This issue can be a result of not using the 65W power adapter with the PowerBook G4 (15-inch FW 800) or later computers. Confirm with the customer which adapter they were using when having this problem. The adapter can be identified by 65W in the name and markings, and the metal securing-stud on the plug connector.

1. Disconnect all external peripherals and eject any PC card.
2. Make sure a known-good fully charged battery is fully inserted. Check that the battery latch is fully engaged and is not broken or getting caught before fully catching. Check battery connection to logic board.
3. Make a visual inspection of the battery connector in the battery bay. Make sure all blades are visible and not bend. If damaged replace the battery connector.
4. Make sure system is not over heating, the air vents are clear and unit was not used on a soft surface.
5. Check that the blower cables are connected and the blowers are operational.
6. Make sure all feet are still on the system bottom. If not, order foot replacement kit.
7. Check that the thermal material between the heat exchanger and logic board is in contact with both by unscrewing the logic board screws and gently pulling up on the left side of the board to verify resistance caused by adhesion from the thermal material. If not, new thermal materials for the processor, control ASIC, and video chip must be reinstalled (see Logic Board Take Apart chapter).
8. Remove the battery and connect known-good 65W power adapter and power cord or plug to a known-good power outlet; make sure the DC plug is firmly inserted. The DC plug should light up, if not, replace Sound/DC-in board.
9. Verify Sound/DC-in board cable is securely connected and cable shows no signs of wear.
10. Try known-good Sound/DC-in board.
11. Replace the logic board.

System shuts down almost immediately after startup

1. Disconnect all external peripherals and eject any PC card.
2. Make sure a known-good battery is fully inserted. Check battery charge and make sure that at least two LED charge indicators light, otherwise connect the adapter. The adapter should light amber when plugged in. If not, replace the adapter.
3. After charging for a while, if battery does not seem to charge, or if charged up but quickly discharges, replace the battery. Verify known-good battery.
4. Check battery connection to logic board, and check wire attachment to connectors.
5. If known-good battery does not charge, replace Sound/DC-in board.
6. Replace the logic board.

Application Quits, Kernel panic or other booting problems

1. If a specific application quits, replace the application. Verify the application is compatible with OS X.
2. Clear parameter RAM. Hold down Command-Option-P-R during startup until you hear a second startup chime.
3. Run Disk Utility from the Software Install and Restore DVD.
4. Perform a clean install of system software with the software install and restore disc that came with the computer.

Note: Restore disc images are available at <http://service.info.apple.com>. Select “Disc Images.”

5. Reboot system.
6. Run Apple Service Diagnostic in loop mode (Control-L) for an extended time to test the memory. If the test finds bad memory, replace the DIMMs one at a time and test until all bad DIMMs are replaced with known-good modules.
7. Replace the logic board.

Error Beeps

The computer automatically performs a power-on self test when it is turned on after being fully shut down (not a restart). This section describes what to do if beeps are heard during the startup. When this occurs, the sleep LED will stay on—occasionally flashes.

Note: The PowerBook G4 (15-inch Double-Layer SD) uses PC4200 DDR2 SDRAM SO-DIMMs, with a maximum height of 1.25-inch (30 mm). These modules are keyed differently than previous PowerBook G4 1.25-inch RAM. Refer to Memory Card Take Apart chapter for removal and installation.

Computer beeps once at startup

1. One beep means that no RAM is detected.

Note: There is no RAM on the logic board itself, so the computer will beep if no memory is installed in at least one of the RAM slots.
2. Put the original RAM that came with the computer back in, or put in known-good and compatible RAM and restart.
 - If symptom does not repeat, replace RAM card(s).
 - If symptom repeats, replace logic board.

Computer beeps twice at startup

1. Two beeps means that EDO memory is installed in the RAM expansion slot. The PowerBook does not accept EDO memory.
2. Replace RAM card(s) with known-good and compatible RAM and restart.
 - If symptom repeats, replace logic board.

Computer beeps three times at startup

1. Three beeps means that no RAM banks passed memory testing.
2. If a RAM card is installed in the upper expansion slot (if not, skip to next step), remove it and restart.
 - If symptom does not repeat, replace RAM card.
 - If symptom repeats, replace RAM in lower RAM slot with known-good and compatible RAM card and restart. If symptom repeats, replace logic board.
3. If a RAM card is not installed in the upper expansion slot, replace RAM in lower RAM slot with known-good and compatible RAM card and restart.
 - If symptom repeats, replace logic board.

Computer beeps four times at startup

1. Four beeps indicates a bad checksum for the remainder of the boot ROM. The ROM (which is located on the logic board) is bad.
2. Replace RAM card(s) with known-good and compatible RAM and restart.
 - If symptom repeats, replace logic board.

Related Knowledge Base articles:

58442: Power On Self-Test Beep Definition - Part 2

95132: PowerBook G4: Installing or Replacing Memory

AirPort Extreme

Note: For the PowerBook G4 (15-inch Double-Layer SD), the AirPort Extreme and Bluetooth 2.0 functions are combined on a single card.

AirPort Extreme not recognized

1. In Mac OS X, use Software Update in system preferences or see the Apple Software Updates web page to make sure the latest version of AirPort Extreme software is installed.
2. Restart the computer.
3. Open AirPort in system preferences and make sure AirPort is on and Base Station is selected.
4. Check the AirPort Extreme w/ Bluetooth card flex cable connection to the logic board.
5. Remove and reinstall the AirPort Extreme software.
6. Replace with known-good AirPort Extreme w/ Bluetooth card.
7. Replace logic board.

AirPort connection is slow

1. Move computer closer to AirPort Base Station or other AirPort device.
2. Too many users are accessing network at the same time causing heavy network traffic. To improve network connection speed, add additional AirPort Base Stations.
3. Check for other changes in the environment that may cause interference with the AirPort signal.
4. Use Software Update in system preferences or see the Apple Software Updates web page to make sure the latest version of AirPort Extreme software is installed.
5. Restart the computer.
6. Check the AirPort Extreme w/ Bluetooth card flex cable connection to the logic board.
7. Replace with known-good AirPort Extreme w/ Bluetooth card.
8. Check AirPort Extreme antenna wire coming from display panel for nicked insulator or crimped wire. If bad, replace the display rear housing (which includes the wireless antenna jumper assembly, or replace separately if available).
9. Replace logic board.

Battery

Battery will not pop up

1. Flip over the unit and turn the battery latch clockwise.
2. If the battery does not pop up, use a small plastic flat-blade tool to pry up the battery around the battery latch.
3. Verify proper latch operation, by exercising the latch. If it does not move smoothly or evenly, replace the bottom case.
4. If the latch does exercise correctly, verify that the customer is not installing the battery with excessive force or the body of the battery has not been deformed around its perimeter.

Warning: If the battery plastic housing has been damaged, or the two halves of the plastic housing have separated, the battery is unsafe for use.

Note: If there is no sign of abuse (dents, scratch marks) replace the battery under warranty.

5. Try a new battery.
6. Replace bottom case.

The battery won't charge

1. Remove any externally connected peripherals.
2. Try known-good power outlet.
3. Connect known-good 65W power adapter and power cord or plug; make sure the DC plug is firmly inserted. The DC plug should light up, if not, replace Sound/DC-in board.

If the power adapter light is green, turn over the computer and press the battery button. The battery lights should glow green and stay on if the power adapter is operating correctly.

Important: The Apple 65W Power Adapter is highly recommended be used with the PowerBook G4 (15-inch FW 800) or later computer. The adapters can be identified by 65W in the name and markings, and the metal securing-stud on the plug connector. Although previous 45W power adapters (see Knowledge Base article 88231 PowerBook and iBook: Apple Power Adapter) are plug compatible with the PowerBook G4 (15-inch FW 800) or later, it may not provide sufficient power to operate the system during some activities and may draw power from the battery.

4. Try known-good battery. If it charges, replace the battery. If doesn't charge, check the battery connector and its connection to the logic board.
5. Replace the battery connector assembly (requires removing the logic board).

-
6. Reset the power manager. See new procedures under the “Resetting the Power Manager Unit (PMU)” heading in the Hardware Troubleshooting Tools and Tips section.

Warning: Resetting the power manager will permanently remove a RAM disk, if present, and all of its contents. You will also need to reset the date and time (using the Date & Time system preference pane).

7. Make sure the Sound/DC-in cable is firmly connected. Look for damaged insulation or wires.
8. Replace Sound/DC-in power cable.
9. Replace Sound/DC-in board.
10. Replace logic board.

Battery won't charge completely

If the battery appears to stop charging between 95 and 99 percent, this is normal operation. Refer to Knowledge Base article 88344: PowerBook G4, iBook: battery does not show full charge in Mac OS X.

Short battery life

Useful Knowledge Base articles:

- 86440, PowerBook, iBook: Battery Life, for tips on extending battery life and explanations of some concepts of battery use.
- 88231, PowerBook and iBook: Apple Power Adapter.
- 50666, Tips for maximizing your PowerBook and iBook battery charge
- 86284, Calibrating your computer's battery for best performance

Three categories to consider:

- There is a system issue (not the battery).
 - If you have the customer's power adapter, plug it into a known good outlet and verify that it can charge the system. Also make sure it is the correct 65W adapter.
 - Plug a known good 65W adapter into a known good outlet. Verify that the DC connector is fully seated into the computer.
 - Check whether the customer's system is setup for heavy battery power use (AirPort on, optical media always in drive, Energy Savings set to Highest Performance, etc.)
 - Test the computer with all third-party devices (printers, hubs, third-party keyboard or mouse) removed.
 - Reset the power manager. See new procedures under the “Resetting the Power Manager Unit (PMU)” heading in the Hardware Troubleshooting Tools and Tips section.

-
- The battery needs calibration, or it is nearing the end of its useful life.
 - Calibration should be done when you first use the battery, and every few months after. It allows the battery to properly calculate how much power is left in the battery.
 - The battery is a consumable part. It can be charged and discharged only so many cycles before it becomes depleted and can no longer hold a charge.
 - **Note:** The battery calibration procedure has been changed for the PowerBook G4 aluminum 15-inch series. The PowerBook G4 (15-inch Double-Layer SD) system introduced a main battery with a new controller chip. The following new procedure works for both old and new battery designs. Also refer to Knowledge Base article 86284, [Calibrating your computer's battery for best performance](#).
 1. Plug in the power adapter and fully charge your PowerBook battery until the light on the power adapter plug changes to green and the onscreen meter in the menu bar indicates that the battery is fully charged.
 2. Allow the battery to rest in the fully charged state for two hours or longer. You may use your computer during this time as long as the adapter is plugged in.
 3. Disconnect the power adapter with the PowerBook on and start running it from the battery. You may use your computer during this time. When your battery gets low, you will see the low battery warning dialog on the screen.
 4. Continue to keep your computer turned on until it goes to sleep. Save all your work and close all applications when the battery gets low and before the system goes to sleep.
 5. Turn off the computer or allow it to sleep for five hours or longer.
 6. Connect the power adapter and leave it connected until the battery is fully charged again.
 - The battery has a defect.
 - Symptoms include, but are not limited to, a relative new battery that will not charge at all, reports an “X” in the menu bar icon, status light on its case that will not go out. In the first two cases, the battery may need calibration—try this first. In addition, after troubleshooting at the system level, if it is demonstrated that the battery is causing abrupt shut-downs or goes to sleep without warning, the battery can be considered severely degraded and follow the criteria below.
 - After recalibrating the battery, test it under the performance test specified in Knowledge Base article 86440. If the battery lasts less than two hours, it is considered to have severely degraded performance.
 - **Warranty Note:** If the battery was purchased (either with the computer or as a standalone part) in the last 90 days and exhibits severely degraded performance (as defined above) provide an in-warranty replacement. If the battery was purchased between the last 90 to 365 days, have the customer calibrate their battery. If after recalibration, the battery still exhibits severely degraded performance, then provide an in-warranty replacement. If the battery was purchased more than 365 days ago, the customer will need to purchase a new battery.

Bluetooth

Note: For the PowerBook G4 (15-inch Double-Layer SD), the AirPort Extreme and Bluetooth 2.0 functions are combined on a single card.

Bluetooth system preferences does not show up under Hardware system preferences

1. Check for software/firmware updates on the web.
2. Check the AirPort Extreme w/ Bluetooth card flex cable. Make sure the cable is not damaged and fully seated.
3. Replace AirPort Extreme w/ Bluetooth card.
4. Replace the logic board.

Bluetooth Card not recognized by other devices

1. Open Bluetooth in system preferences and make sure under the Settings tab that Discoverable is checked.
2. Check the Bluetooth antenna is connected to AirPort Extreme w/ Bluetooth card.
3. Replace with known-good AirPort Extreme w/ Bluetooth card.
4. Replace logic board.

Display

Display latch not working

Note: When the display is being closed, a latch hook in the top of the display housing should be magnetically pulled down through the slot in the top case and secured by the latch mechanism. When the latch button is pushed, the hook should release and retract into the display housing.

1. See the Latch Adjustment chapter in the Adjustments section of this service manual to verify the latch mechanism and latch hook operation and make adjustments, if necessary.
2. If the latch hook is broken, replace the display latch hook assembly.

When displaying a single color over the screen area, the LCD panel shows one or more pixels that are not properly lit

To determine whether or not the display has an acceptable number of pixel anomalies, follow the steps below:

1. Set the display image to one of the following colors: all-white display, all-red display, all-green display, or all-blue display. Knowledge Base article 112125: Service Diagnostics Matrix, has the LCD Tester Diagnostic Utility that will generate these patterns on the screen.
2. Using a jeweler's loupe, pocket microscope, or other magnifying device, identify and count each pixel anomaly:
 - Bright subpixel anomaly = subpixel that is always on
 - Dark subpixel anomaly = subpixel that is always off
3. The number of acceptable pixel anomalies for this system is:

Acceptable Number of Subpixel Anomalies

Bright	Up to 3
Dark	Up to 5
Combination	Up to 7

4. If the number of subpixel anomalies exceeds the acceptable number listed in the above chart, replace the display panel assembly.

Replace

Bright	4 or more
Dark	6 or more
Combination	8 or more

-
5. If the number of subpixel anomalies is acceptable, explain to the customer that the pixel anomalies are within specifications, and no repair is necessary.

Important: Do not release the specifications to customers. Instead, inform them that a certain number of subpixel anomalies are considered acceptable, and these factors apply to all manufacturers using LCD technology—not just Apple products.

When speaking with customers, please use the following explanation:

Active-matrix LCD technology uses rows and columns of addressable locations (pixels) that render text and images on screen. Each pixel location has three separate subpixels (red, green, and blue) that allow the image to be rendered in full color. Each subpixel has a corresponding transistor responsible for turning the subpixel on or off.

There are typically millions of these subpixels on an LCD display. For example, the LCD panel used in the Apple Cinema HD display is made up of 2.3 million pixels and 6.9 million red, green, and blue subpixels. Occasionally, a transistor does not work perfectly, which may result in the affected subpixel being turned on (bright) or turned off (dark). With the millions of subpixels on a display, it is quite possible to have a low number of faulty transistors on an LCD. Therefore, a certain number of subpixel anomalies are considered acceptable. Rejecting all but perfect LCD panels would significantly increase the retail price for products using LCD displays. These factors apply to all manufacturers using LCD technology—not just Apple products.

Hard Drive

Internal hard drive will not initialize:

1. Make sure the hard drive is a cable select drive set as a master (0). Using the previous Apple hard disk drives in this machine may cause problems at start up.
2. Start up from the software install and restore disc that came with the computer (hold down the "C" key during restart).
3. When the Installer opens, from the Installer menu, select Open Disk Utility.
4. If the hard drive is recognized, format it under the Erase tab.
5. If the hard drive is not recognized, reseal the hard drive flex cable, or replace if needed.
6. If still not recognized, replace the hard drive.
7. Reinstall system software using the software install and restore disc.

Important: If the computer is under warranty and data recovery is required, refer to Knowledge Base article 31077: DriveSavers: Hard Drive Data Recovery & Warranty Implications, for important information.

Keyboard

No response from any key on keyboard

1. Remove any connected peripherals and eject any PC card.
2. Attach an external USB keyboard, if it doesn't work, go to step 6.
3. Turn off the computer. Check the keyboard flex cable connection to the trackpad, and the trackpad flex cable connection to the main logic board (especially check the connectors for damage).
4. Start up from the software install and restore disc that came with the computer (hold down the "C" key during restart, if possible) to verify that it is not a software problem.
5. Replace keyboard.
6. Replace top case.
7. Replace logic board.

No keyboard illumination

1. Go to Keyboard system preference pane and make sure the "Illuminate keyboard in low light conditions" check box is checked. Try using system in a dimly lit environment.

Note: The keyboard illumination is not bright enough to be seen in most well lit spaces. In order to view the key being illuminated, the ambient light needs to be dim.

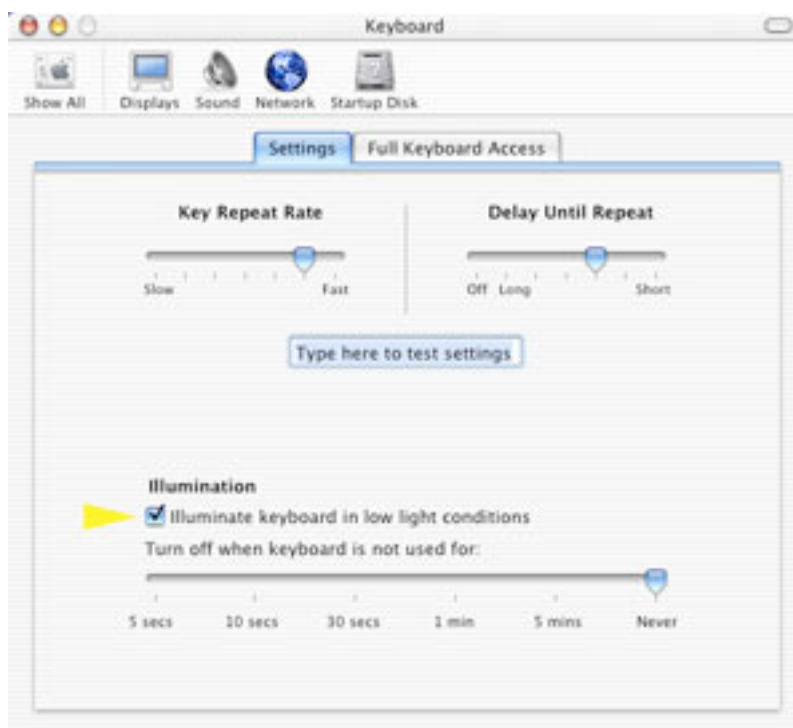

-
2. Check the keyboard backlight cable connection to the trackpad, if bad, replace the top case.
 3. Replace the left and right ambient light sensors.
 4. Replace logic board.

Keyboard is partially illuminated.

1. Check the keyboard backlight cable connection to the trackpad assembly and the trackpad flex cable connection to the logic board. If the connections look good, replace the keyboard.
2. Replace keyboard.

Microphone

The microphone is not working

1. Check the Sound system preference pane and verify the selection under the Input tab is for the built-in microphone.
2. Check the signal level and level meter and adjust the gain.
3. Reset PRAM (Press the power button, then hold down the Option-Command-P-R keys until you hear the startup chime at least one additional time after the initial startup chime).

Warning: Resetting the PRAM will permanently remove a RAM disk, if present and all of its contents. You will also need to reset the date and time (using the Date & Time system preference pane).

4. If there is no sound output from the internal speaker as well as the microphone not working, verify cable connections.
5. Replace the speaker assembly (which contains the microphone).
6. Replace sound/DC-in board flex cable.
7. Replace the sound/DC-in board.
8. Replace the logic board.

Modem

No modem dial tone

1. Check that the correct modem is selected in the Network Port Configuration section of the Network system preferences.
2. Verify known-good analog (not digital) telephone line.
3. Verify known-good RJ-11 telephone cable.
4. Verify RJ-11 cable is not plugged into Ethernet port (should not be physically possible with this PowerBook).
5. Inspect RJ-11 connector for pin damage.
6. Verify RJ-11 telephone cable is firmly installed in the modem port.
7. Open Apple System Profiler, and under the Software tab look at Extensions. Check to see that the MotorolaSM56K and AppleI2SModem Family files are listed and loaded. If not, restart the system and check again. If still not visible replace system software.
8. Open Apple System Profiler, and under the Hardware tab look at Modem. It should show the modem presence by indicating the Modem as Jump. If not visible, start checking modem card connection.
9. Check RJ-11 wires to modem board. Replace the RJ-11 cable assembly, if bad.
10. Check modem flex cable is properly installed between the modem card and main logic board. Replace cable if needed.
11. Replace modem card.
12. Replace logic board.

Modem does not respond (can hear dial tone)

1. Check that the correct modem is selected in the Network Port Configuration section of the Network system preferences.
2. Check modem application is properly configured.
3. Open Apple System Profiler, and under the Software tab look at Extensions. Check to see that the MotorolaSM56K and AppleI2SModem Family files are listed and loaded. If not, restart the system and check again. If still not visible replace system software.
4. Check modem flex cable is properly installed between the modem card and main logic board. Replace cable if needed.
5. Replace modem card.
6. Replace logic board.

Modem intermittently disconnects or low performance

1. Verify known-good RJ-11 telephone cable (for example, the retaining clip is not broken off) and it is firmly installed when used. If telephone cable is bad, replace it.
2. Ask if issue happens with only one particular phone line, but not another. The problem may be an issue with that particular phone line. Under bad line condition, try setting the modem script to start with a slower connect rate such as “Apple Internal 56K Modem (v.34).”
3. If the customer indicates the system disconnects under very high CPU loads such as burning DVDs and/or working with video editing software such as Final Cut Pro, try connecting the modem without any application running and see how the modem performs. Use Knowledge Base article 106642: “Mac OS X: Using Apple PPP Test Server” to test the modem. If OK, ask the customer if the task of connecting the modem can be done separately or with less applications running simultaneously.
4. Check RJ-11 wires to modem board. Replace the RJ-11 cable assembly if there is signs of damage.
5. Check modem flex cable is properly installed between the modem card and main logic board. Replace cable if needed.
6. Replace modem card.
7. Replace the logic board.

Optical Drive

Optical Drive not recognized

1. Make sure the optical drive is a cable select drive set as a slave (1). Although previous Apple optical drives will fit in this machine, their address configurations will cause problems at boot up.
2. Make sure the optical drive flex cable is undamaged and properly installed. If bad, replace.
3. Replace optical drive.

The optical drive does not accept CD or DVD disc (mechanical failure)

1. Verify disc is not warped and is a 12 cm circular disc.
2. Check that a small disc is not stuck inside, or other foreign objects. Remove drive from system to extract disc.
3. Verify disc is pushed almost all the way into the slot.
4. Check the optical drive flex cable.
5. Replace optical drive.

The optical drive does not eject CD or DVD disc

1. Verify disc is not in use by quitting any applications that may be using the disc.
2. Press and hold Media Eject key at top right corner of keyboard. If that does not work, hold down Function (fn) key and Media Eject key.
3. Drag disc icon to trash or select it and press Command-E.
4. Choose Restart from Apple menu while holding down trackpad button.
5. Reseat the optical drive mechanism. Make sure the drive is biased toward the back of the computer.
6. Replace optical drive. (See “How to remove a stuck disc from the optical drive” heading of the Optical Drive chapter in the Take Apart section of this manual.)

The disc icon does not show up on desktop, or a dialog box appears to initialize disc, when inserting a read-only disc

1. Verify the correct type of disc is being used.
2. Use Software Update system preference pane to check if there is updated firmware.
3. Try cleaning the disc. If it is dirty or scratched, it may not mount.
4. Try a different disc.
5. Replace optical drive cable.
6. Replace optical drive.

Difficulty writing to optical media

1. Verify the correct type of disc is being used.
2. Try a different brand or speed of CD-R disc.

Note: Some brands of 24x or 32x CD-R media may not work with the SuperDrive.

Note: There are two factors in the ability for the optical drive to write to media. First, there are varying qualities of blank optical media. Some media are made to such low specifications that the ability for the drive to write to it is marginal.

There are variations in optical media even under the same brand. Some brands source their optical media from a variety of manufacturers, so there may be variations in the quality.

Second, an optical drive that supports writing to a CD-R/RW or DVD-R/RW disc requires a special writing algorithm for discs from different disc manufacturers. There are hundreds of disc manufacturers, it is impossible to implement writing algorithms for each disc manufacturer. Usually, drive manufacturers implement special writing algorithms for discs from major disc manufacturers. For discs that are not supported by the drive with special writing algorithms, the drive will use a generic writing algorithm to write the disc. In this case, the writability and readability may not be optimal.

3. Replace optical drive flex cable.
4. Replace optical drive.

PC Card

PC Card will not insert into the PC Card slot

1. Make sure the PC Card eject button is in, before attempting to insert a PC Card, and there is no foreign object lodged in the card cage.
2. Make sure the PC Card is right side up (cards are keyed and cannot be inserted upside down).
3. Verify the PC Card is not warped or damaged in any way; if so replace the card.
4. Try a different PC Card.
5. Carefully raise the PC Card slot cover and check for a foreign object inside the slot.
6. If the slot cover is preventing the card from being inserted, replace the top case.
7. Replace PC Card Cage.

PC Card does not mount to the desktop

1. Make sure the PC Card has its drivers installed.
2. Check if a known-good PC card works in this slot. The PC card may be bad.
3. Check the PC card cage flex cable connection to the logic board.
4. Replace the PC card cage.
5. Replace the logic board.

Ports

A USB port is not recognizing devices

1. Completely shut down, then press the power button to start the computer.
2. Use Software Update system preferences to verify that the latest software is installed.
3. For USB, test ports with an Apple keyboard or mouse. If the left port is not recognized check the Sound/DC-in flex cable's condition and connection. If the right port is not recognized check the right USB flex cable's condition and connection.
4. If the USB flex cables are fine, replace the Sound/DC-in board for the left USB port or the backup battery board for the right port.
5. Use Apple System Profiler to verify that the computer is recognizing the bus. If not replace the logic board.

A USB device not recognized by computer

Note: If you are trying to use a serial device with a USB/Serial adapter, check with the manufacturer of the adapter for compatibility.

1. Completely shut down, then press the power button to start the computer.
2. Verify current driver for the device is installed.
3. If a camera, turn on camera after initiating download with camera application.
4. Try the other USB port.
5. Try different USB device on same port.
6. Eliminate chain by plugging in only one peripheral.
7. Try known-good Apple USB keyboard or mouse to verify the port is working properly. If the left port is bad, check the Sound/DC-in board flex cable and connections. If the right port is bad, check the backup battery flex cable and connections.
8. If the USB flex cables are fine, replace the Sound/DC-in board for the left USB port or the backup battery board for the right port.
9. Replace logic board.

A FireWire port is not recognizing devices

1. Test the FireWire 400 and FireWire 800 ports by connecting to another computer using FireWire Target Disk Mode.

Refer to Knowledge Base article 58583: How to Use FireWire Target Disk Mode.

Important: When in FireWire Target Disk Mode, use only one FireWire port at a time. Otherwise you risk corrupting the internal hard drive volume.

2. Verify that drivers are installed properly for third party, if needed.
3. Make sure the cables are firmly attached.
4. Try a different cable.
5. If self powered make sure that the power supply is connected and device's LED indicates that it is getting power.
6. Replace logic board.

Sound

No sound heard and the Speakers section of the Sound system preference pane indicates that an external device is plugged in (to the headphone jack or USB ports)

1. If there is nothing plugged into the headphone jack or USB ports, under the Output tab of the Sound system preference pane should be set to the internal speakers.
2. If not, and if nothing is plugged in, try plugging in headphones or external speakers. Restart the computer. Remove the device.
3. Reset PRAM (Press the power button, then hold down the Option-Command-P-R keys until you hear the startup chime at least one additional time after the initial startup chime).

Warning: Resetting the PRAM will permanently remove a RAM disk, if present, and all of its contents. You will also need to reset the date and time (using the Date & Time system preferences pane).

4. Check the sound board flex cable to see if the cable is properly seated, the connection is good, and there is no cable damage.
5. Replace sound board.
6. Replace logic board.

No sound from speaker(s)

1. Use the Software Update system preference pane to verify that the latest audio update has been installed.
2. Press the F3 key (with the fn key pressed and not pressed) to verify that mute mode is not enabled.
3. Press the F4 or F5 key (with the fn key pressed and not pressed) to check the volume setting.
4. Verify no external speakers or headphones are plugged in.
5. Check the speakers tab on the Sound control panel to confirm that the software is correctly seeing that there are no external speakers or headphones connected.
6. Shutdown computer and restart.
7. Reset PRAM (Press the power button, then hold down the Option-Command-P-R keys until you hear the startup chime at least one additional time after the initial startup chime).

Warning: Resetting the PRAM will permanently remove a RAM disk, if present, and all of its contents. You will also need to reset the date and time (using the Date & Time system preference pane).

8. Verify that the speaker cable is connected properly to sound board.

-
9. Check speaker cable. Verify left and right cable connections.
 10. Check with headphones or external speaker, if audio is heard, replace speaker assembly.
 11. Replace sound board flex cable.
 12. Replace sound board.
 13. Replace the logic board.

Distorted sound from speakers

1. Verify sound is correct with external speakers/headphones. If sound is correct, check speaker wire and connections.
2. In Sound system preference pane, check balance.
3. Compare same sound with two different units to make sure that sound is actually distorted.
4. Check speaker wire. If damaged, replace speaker assembly.
5. Replace sound board.
6. Replace sound board flex cable.
7. Replace logic board.

Trackpad

The cursor does not move when you are using trackpad

1. Verify that no USB device is connected.
2. Boot from the Software Install and Restore DVD to verify that it is not a software problem. If the trackpad works, restore the system software.
3. Reset the power manager. See new procedures under the “Resetting the Power Manager Unit (PMU)” heading in the Hardware Troubleshooting Tools and Tips section.
4. Check trackpad flex cable connection to the logic board.
5. Replace top case.
6. Replace logic board.

The cursor intermittently does not move or moves erratically

Notes:

- User must touch with the surface of only one finger at a time and point directly down on the trackpad surface.
 - When running Apple Hardware Test or Apple Service Diagnostic, the trackpad will respond in very small movements of the cursor. This behavior is normal.
1. Clean trackpad surface (with computer off, using a non-static-inducing material).
 2. Completely shut down, then press the power button to start the computer.
 3. Reset the power manager. See new procedures under the “Resetting the Power Manager Unit (PMU)” heading in the Hardware Troubleshooting Tools and Tips section.
 4. Try unit on battery power. If problem goes away, replace power adapter.
 5. Place the Software Install and Restore DVD in the optical disc drive, press the start button and hold down the "C" key. Check the cursor movement, to see if the problem is software.
 6. Check trackpad flex cable connection to the logic board.
 7. Replace top case.
 8. Replace logic board.

Video

No display, or dim display, but computer appears to operate correctly

1. Remove any connected peripherals.
2. Make sure F1 key is not stuck down.
3. Press the F2 key (with the fn key pressed and not pressed) to increase the screen brightness settings.
4. Reboot the computer—hold down the Control and Command keys and press the Power button to restart the computer. Or, press and hold the Power button for 5 to 10 seconds to shut down the computer, then press the Power button to restart.
5. **Important:** The Apple 65W Power Adapter is highly recommended be used with the PowerBook G4 (15-inch FW 800) or later computer. The adapters can be identified by 65W in the name and markings, and the metal securing-stud on the plug connector. Although previous 45W power adapters (see Knowledge Base article 88231 PowerBook and iBook: Apple Power Adapter) are plug compatible with the PowerBook G4 (15-inch FW 800) or later, it may not have sufficient power to operate the system during some activities and may draw power from the battery.
6. Verify inverter cable and LVDS cable connections are seated properly and that the cables are not damaged.
7. Replace inverter board.
8. Replace the display rear housing (which includes the inverter cable assembly, or replace separately if available).
9. Replace logic board.
10. Replace LCD panel.

Computer appears to work, but no video on external device connected to the TV out port (S-video out port)

1. The device must be connected to the S-video port while the PowerBook is sleeping or off for the device to be recognized.
2. Verify monitor that is used in testing is known-good and is supported by this computer.
3. Try different cable(s).
4. Replace logic board.

No video on an external VGA device connected to the external monitor (DVI) port

1. Verify monitor that is used in testing is known-good and is supported by this computer.
2. Try another DVI-to-VGA adapter cable.
3. Restart the computer and test again.
4. Replace logic board.

No display, or dim display, but can display external video

1. Remove any connected peripherals.
2. Open Display system preference panel and check brightness. If works, replace keyboard.
3. Check connection of the inverter cable to the main logic board.
4. Check inverter cable connection to the inverter board and the inverter to the LCD cable connection.
5. Replace inverter board.
6. Replace display rear housing (which includes the inverter cable assembly, or replace separately if available)
7. Replace display panel.
8. Replace logic board.

Display has repetitive patterns

1. Check the LVDS connection on the logic board.
2. Replace logic board.

Display shows shifted color patterns

1. Replace LVDS cable.
2. Replace logic board.

Display has permanent vertical or horizontal lines.

1. Replace display panel.
2. Replace logic board.

Misc. Symptoms

The Date and Time settings reset all the time

Note: Resetting the power manager or PRAM resets the date and time.

1. Do a backup battery test:
 - Set the date and time.
 - Perform a Shut Down from the Apple menu.
 - Remove the main battery and disconnect the power adapter for 10 minutes.
 - Connect the power adapter, insert the battery, and power on the computer.
 - If the date and time were lost the backup battery may be dead or discharged.
 - Remove the main battery from the unit and leave the PowerBook plugged in for at least 5 hours.

Note: If a discharged main battery is installed in the computer, recharging the backup battery may take up to 48 hours to completely charge. It is okay to use it while it is charging.

- If the date and time still reset, replace the backup battery cable.

2. Replace backup battery board.
3. Replace the logic board.

Feet came off the bottom case

Replace the missing foot.

Sleep LED does not come on when lid is closed

1. Put the computer to sleep using the menu option. If the sleep LED goes on, there is a problem with sensing the closed display. If the LED does not go on, skip to step 3.
2. With the display housing removed, check the sleep magnet location on the LCD panel: (See the LCD Panel chapter in the Take Apart section of this manual.)
 - If it is not positioned correctly, reposition it.
 - If the magnet is missing, replace it with a new magnet.
3. Check that the sleep LED is plugged into the logic board.
4. Connect a USB mouse. Short the power on pads on the logic board to boot the system and use the mouse to sleep from the menu. Measure the voltage at the LED connector. If power is present, replace bottom case.
5. Replace logic board.

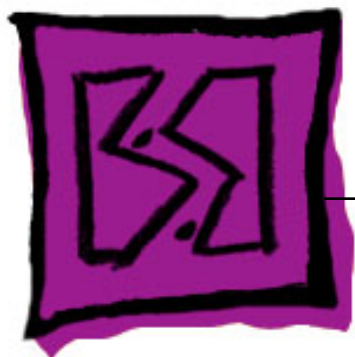

Views

PowerBook G4 (15-inch Double-Layer SD)

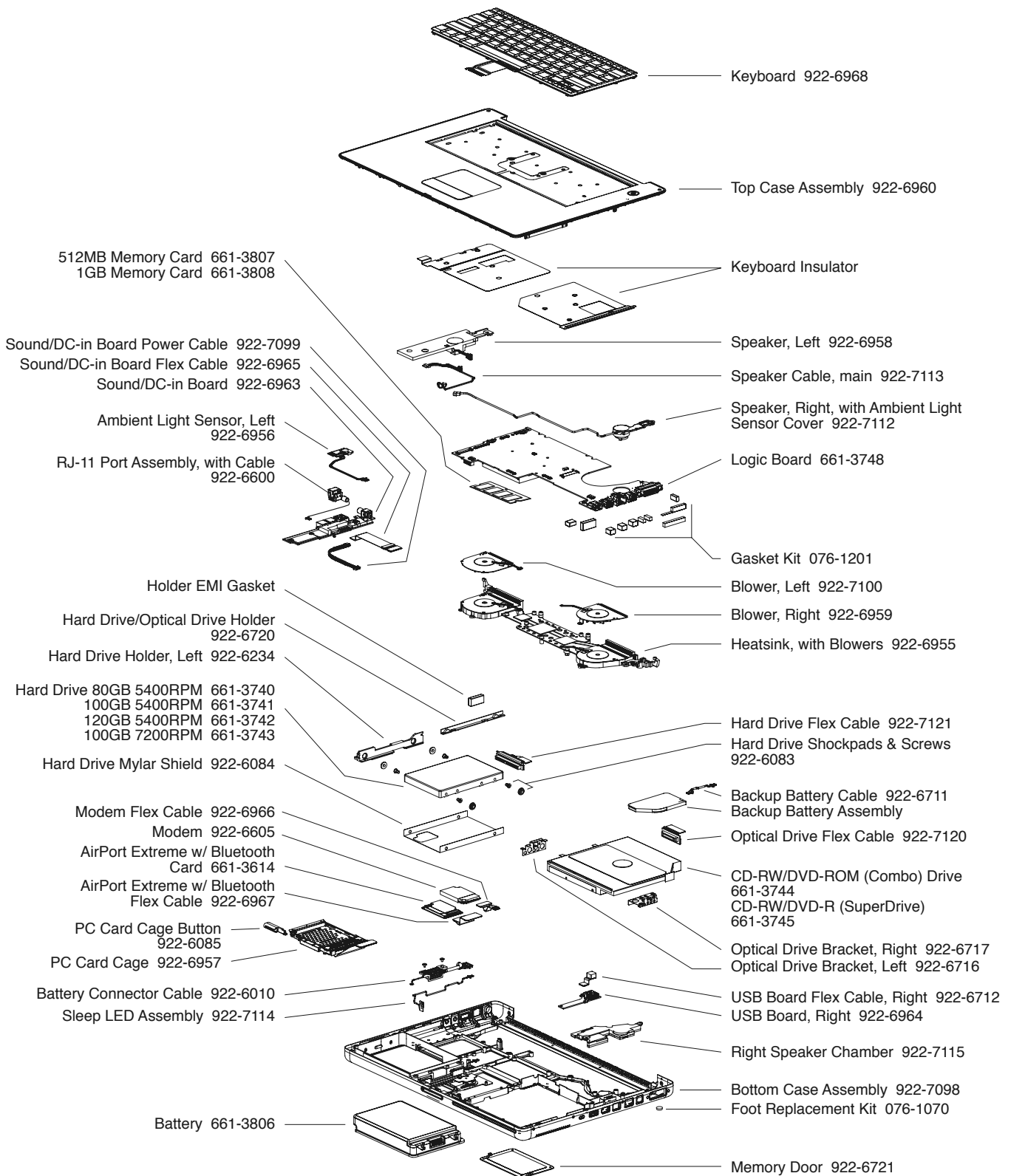

Display Rear Housing, with Logo, Diffuser, and AirPort Extreme and Bluetooth antennas 922-6970

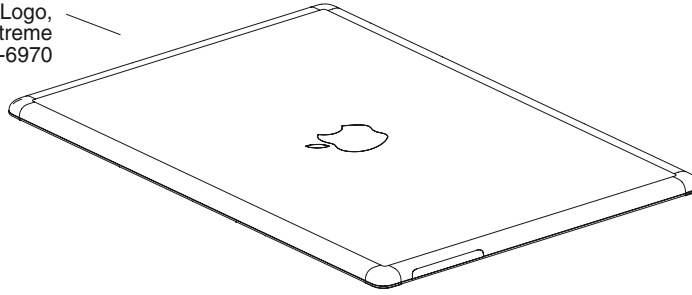

LVDS Cable 922-6961

LCD Panel 661-3749

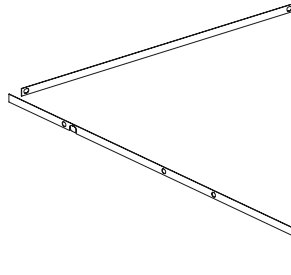
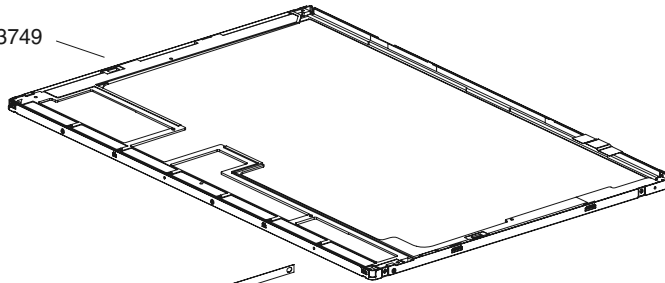

LCD Panel Spacer Kit 076-1196

Clutch, Left 922-6022

Clutch Cap, Left 922-6118

Display Bezel 922-6969

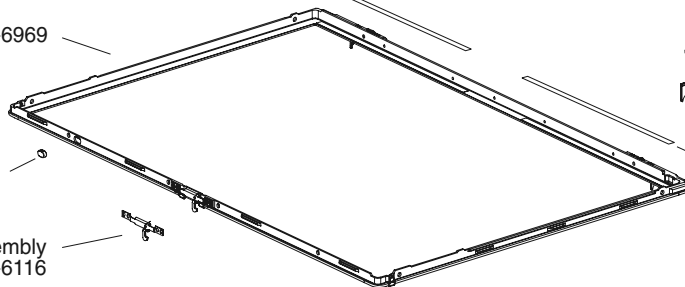

Clutch, Right 922-6021

Clutch Cap, Right 922-6117

Bezel Adhesive Strips 922-6733

Sleep Magnet 922-7117

Display Latch Hook Assembly 922-6116

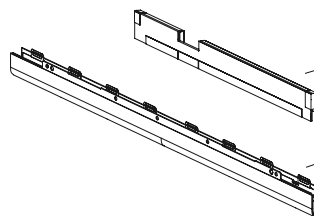

Inverter Board 922-6962

Clutch Cover 922-6020

<p>922-5840 Hexnut 4 mm</p>  <p>Speaker</p>	<p>922-5838 #0 Phillips 1.25 mm</p>  <p>Keyboard</p>	<p>922-6488 #0 Phillips 2.15 mm</p>  <p>Optical Drive Brackets</p>	<p>922-6090 #0 Phillips 3.2 mm</p>  <p>AirPort Chamber ALS Boards Modem Optical Drive, Right Speaker (Left) Bezel to LCD</p>
<p>922-6091 #0 Phillips 3.4 mm</p>  <p>Battery Well Bottom Case (Side) RAM Door</p>	<p>922-6490 3.5 mm</p>  <p>Modem</p>	<p>922-6092 #0 Phillips 3.5 mm</p>  <p>Battery Connector Battery Latch</p>	<p>922-6096 1.5 mm Hex 4.4 mm</p>  <p>Top Case</p>
<p>922-6093 #0 Phillips 4.5 mm</p>  <p>PC Card Cage (Left) Blowers Clutch to Bezel Block</p>	<p>922-6472 #1 Phillips 4.5 mm</p>  <p>Main Logic Board AirPort Card Flex Right USB Board Heatsink</p>	<p>922-6100 #0 Phillips 5.3 mm</p>  <p>Bottom Case (Rear)</p>	<p>922-6474 #1 Phillips 5.5 mm</p>  <p>Right Speaker Heatsink</p>
<p>922-6083 #1 Phillips & Stopper 5.8 mm</p>  <p>Hard Drive</p>	<p>922-6487 1.5 Hex 6.1 mm</p>  <p>Bezel (Bottom Corners)</p>	<p>922-6097 #0 Phillips 6.4 mm</p>  <p>Mass Storage Bracket</p>	<p>922-6470 #0 Phillips 6.6 mm</p>  <p>PC Card Cage (Right)</p>
<p>922-6473 #1 Phillips 6.9 mm</p>  <p>Logic Board</p>	<p>922-6475 #1 Phillips 9.5 mm</p>  <p>(R) ALS to Logic Board Heatsink (Top Left)</p>	<p>922-6719 #0 Phillips 12.6 mm</p>  <p>Bottom Case (under RAM Door)</p>	<p>922-6471 T8 Torx 10.25 mm</p>  <p>Clutch (Rear)</p>
<p>922-6098 T8 Torx 13 mm</p>  <p>Clutch (Front) Sound/DC-In Board</p>	<p>5 mm Hexnut Standoff, 11 mm</p>  <p>Sound/DC-In Board</p>	<p>922-6095 #0 Phillips 16.4 mm</p>  <p>Bottom Case (Bottom)</p>	