

Acer Ferrari 3000 Series

Service Guide

Service guide files and updates are available on the ACER/CSD web; for more information, please refer to <http://csd.acer.com.tw>

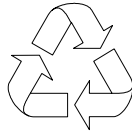

100% Recycled Paper

PART NO.: VD.FR1V7.001

PRINTED IN TAIWAN

Revision History

Please refer to the table below for the updates made on Ferrari 3000 service guide.

Date	Chapter	Updates
2003/11/17	Chapter 4	Add POST codes

Copyright

Copyright © 2003 by Acer Incorporated. All rights reserved. No part of this publication may be reproduced, transmitted, transcribed, stored in a retrieval system, or translated into any language or computer language, in any form or by any means, electronic, mechanical, magnetic, optical, chemical, manual or otherwise, without the prior written permission of Acer Incorporated.

Disclaimer

The information in this guide is subject to change without notice.

Acer Incorporated makes no representations or warranties, either expressed or implied, with respect to the contents hereof and specifically disclaims any warranties of merchantability or fitness for any particular purpose. Any Acer Incorporated software described in this manual is sold or licensed "as is". Should the programs prove defective following their purchase, the buyer (and not Acer Incorporated, its distributor, or its dealer) assumes the entire cost of all necessary servicing, repair, and any incidental or consequential damages resulting from any defect in the software.

Acer is a registered trademark of Acer Corporation.

Intel is a registered trademark of Intel Corporation.

Pentium and Pentium II/III are trademarks of Intel Corporation.

Other brand and product names are trademarks and/or registered trademarks of their respective holders.

Conventions

The following conventions are used in this manual:

SCREEN MESSAGES	Denotes actual messages that appear on screen.
NOTE	Gives bits and pieces of additional information related to the current topic.
WARNING	Alerts you to any damage that might result from doing or not doing specific actions.
CAUTION	Gives precautionary measures to avoid possible hardware or software problems.
IMPORTANT	Reminds you to do specific actions relevant to the accomplishment of procedures.

Preface

Before using this information and the product it supports, please read the following general information.

1. This Service Guide provides you with all technical information relating to the BASIC CONFIGURATION decided for Acer's "global" product offering. To better fit local market requirements and enhance product competitiveness, your regional office MAY have decided to extend the functionality of a machine (e.g. add-on card, modem, or extra memory capability). These LOCALIZED FEATURES will NOT be covered in this generic service guide. In such cases, please contact your regional offices or the responsible personnel/channel to provide you with further technical details.
2. Please note WHEN ORDERING FRU PARTS, that you should check the most up-to-date information available on your regional web or channel. If, for whatever reason, a part number change is made, it will not be noted in the printed Service Guide. For ACER-AUTHORIZED SERVICE PROVIDERS, your Acer office may have a DIFFERENT part number code to those given in the FRU list of this printed Service Guide. You MUST use the list provided by your regional Acer office to order FRU parts for repair and service of customer machines.

Chapter 1	System Specifications	1
	Features	1
	System Block Diagram	3
	Board Layout	4
	Top View	4
	Bottom View	5
	Outlook View	6
	Front Open View	6
	Front Panel	7
	Left Panel	8
	Right Panel	9
	Rear Panel	10
	Bottom Panel	11
	Indicators	12
	Using the Keyboard	13
	Lock Keys	13
	Embedded Numeric Keypad	14
	Windows Keys	15
	Hot Keys	16
	The Euro Symbol	18
	Launch Keys	19
	Touchpad	20
	Touchpad Basics	20
	Hardware Specifications and Configurations	22
 Chapter 2	 System Utilities	 31
	BIOS Setup Utility	31
	Navigating the BIOS Utility	32
	Info.	33
	Main	34
	Advanced	36
	Security	38
	Boot	42
	Exit	43
	BIOS Flash Utility	44
	System Diagnostic Diskette	44
 Chapter 3	 Machine Disassembly and Replacement	 45
	General Information	46
	Before You Begin	46
	Disassembly Procedure Flowchart	47
	Removing the Battery Pack	50
	Removing the Optical Module/HDD Module/ Wireless Lan Card and LCD module	51
	Removing the Optical Module	51
	Removing the HDD Module	51
	Removing the Wireless LAN Card	51
	Removing the LCD Module	52
	Disassembling the Main Unit	53
	Remove the function key board and the keyboard	53
	Separate the main unit into the logic upper and the logic lower assembly	53
	Disassembling the logic upper assembly	54
	Disassembling the logic lower assembly	55
	Disassembling the LCD Module	57

Table of Contents

Disassembling the External Modules	59
Disassembling the HDD Module	59
Disassembling the Optical Drive Module	59
Chapter 4 Troubleshooting	61
System Check Procedures	62
External Diskette Drive Check	62
External CD-ROM Drive Check	62
Keyboard or Auxiliary Input Device Check	62
Memory check	63
Power System Check	63
Touchpad check	64
Power-On Self-Test (POST) Error Message	65
Index of Error Messages	66
POST Codes	68
Index of Symptom-to-FRU Error Message	72
Intermittent Problems	76
Undetermined Problems	77
Chapter 5 Jumper and Connector Locations	79
Top View	79
Bottom View	80
Chapter 6 FRU (Field Replaceable Unit) List	81
Exploded Diagram	82
Appendix A Model Definition and Configuration	90
Ferrari 3000 Series	90
Appendix B Test Compatible Components	91
Microsoft® Windows® XP Home Environment Test	92
Appendix C Online Support Information	97
Index	99

System Specifications

Features

This computer was designed with the user in mind. Here are just a few of its many features:

Performance

- AMD™ XP-M processor at available in 2500+ and higher
- Memory upgradeable up to 2GB with 2 slots (only one slot for user accessible)
- Internal removable DVD drive (AcerMedia bay)
- High-capacity, Enhanced-IDE hard disk
- Li-Ion main battery pack
- Microsoft Windows XP operating system

Display

- Thin-Film Transistor (TFT) liquid-crystal display (LCD) displaying 32-bit high colour up to 1400X1050 Super eXtended Graphics Array (SXGA+) resolution for 15.0"
- 3D graphics engine
- Simultaneous LCD and CRT display support
- S-video for output to a television or display device that supports S-video input
- "Automatic LCD dim" feature that automatically decides the best settings for your display and conserves power
- DualView™

Multimedia

- AC'97 stereo audio
- Built-in dual speakers
- Built-in microphone
- High-speed optical drive
- Built-in optical drive (DVD dual)
- 15.0" TFT SXGA+ (1400x1050 resolution) panel
- Audio input and output jacks

Connectivity

- High-speed fax/data modem port
- Ethernet/Fast Ethernet port
- Fast infrared wireless communication
- Four USB 2.0 (Universal Serial Bus) ports
- IEEE 1394 port
- InVilink 802.11g wireless LAN (manufacturing optional)
- Bluetooth ready (manufacturing optional)
- SD/MMC/SM/MS memory slot (manufacturing optional)

Keyboard and Pointing Device

- 86-/87-key Windows keyboard
- Sleek, smooth and stylish design
- Acer FinTouch full-sized curved keyboard
- Ergonomically-centered touchpad pointing device with four-way scroll button

Expansion

- One type II CardBus PC Card slot
- Upgradeable memory

I/O Ports

- One Card bus type II slot
- One RJ-11 jack for 56Kbps fax/modem
- One RJ-45 jack for LAN
- One DC-in jack for AC adapter
- One ECP/EPP compliant 25-pin parallel port
- One external 15-pin VGA port
- One speaker/headphone/line-out jack
- One audio line-in jack
- One microphone-in jack
- Four USB 2.0 ports
- One IEEE 1394 port
- One S-video (NTSC/PAL) output port
- 4-in-1 Card Reader (Manufacture optional)
- FIR (Fast Infrared) port

System Block Diagram

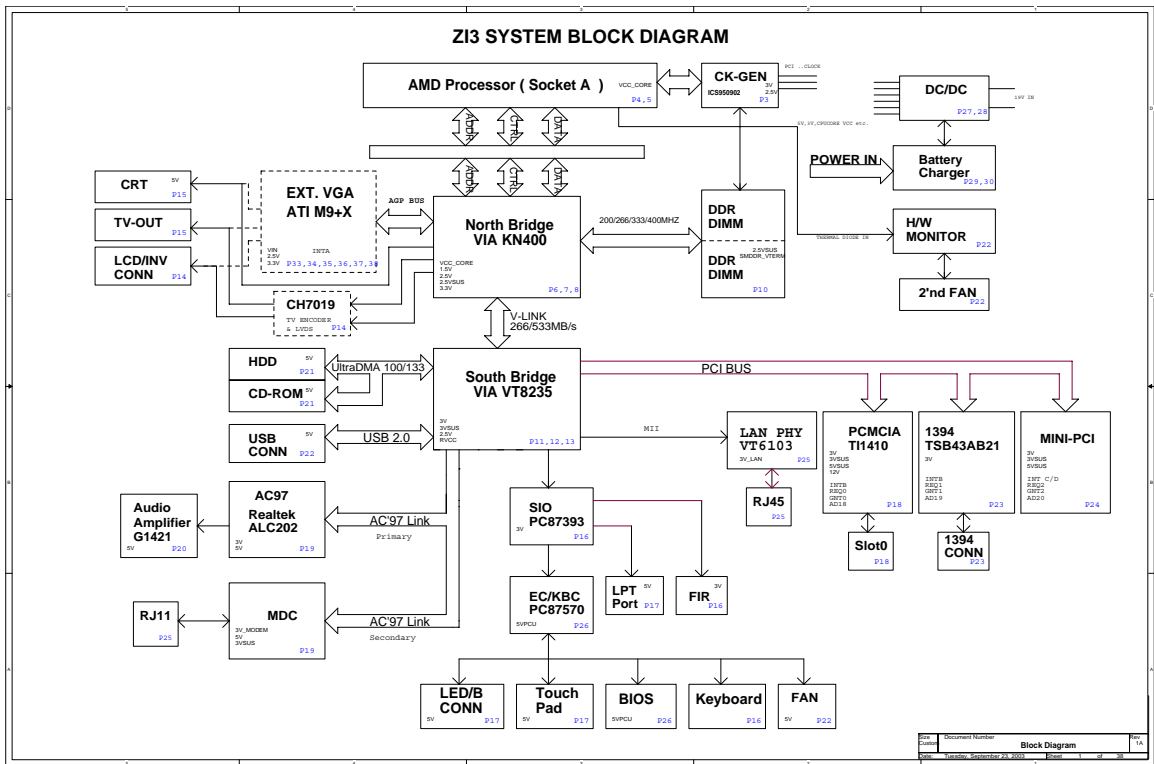

Board Layout

Top View

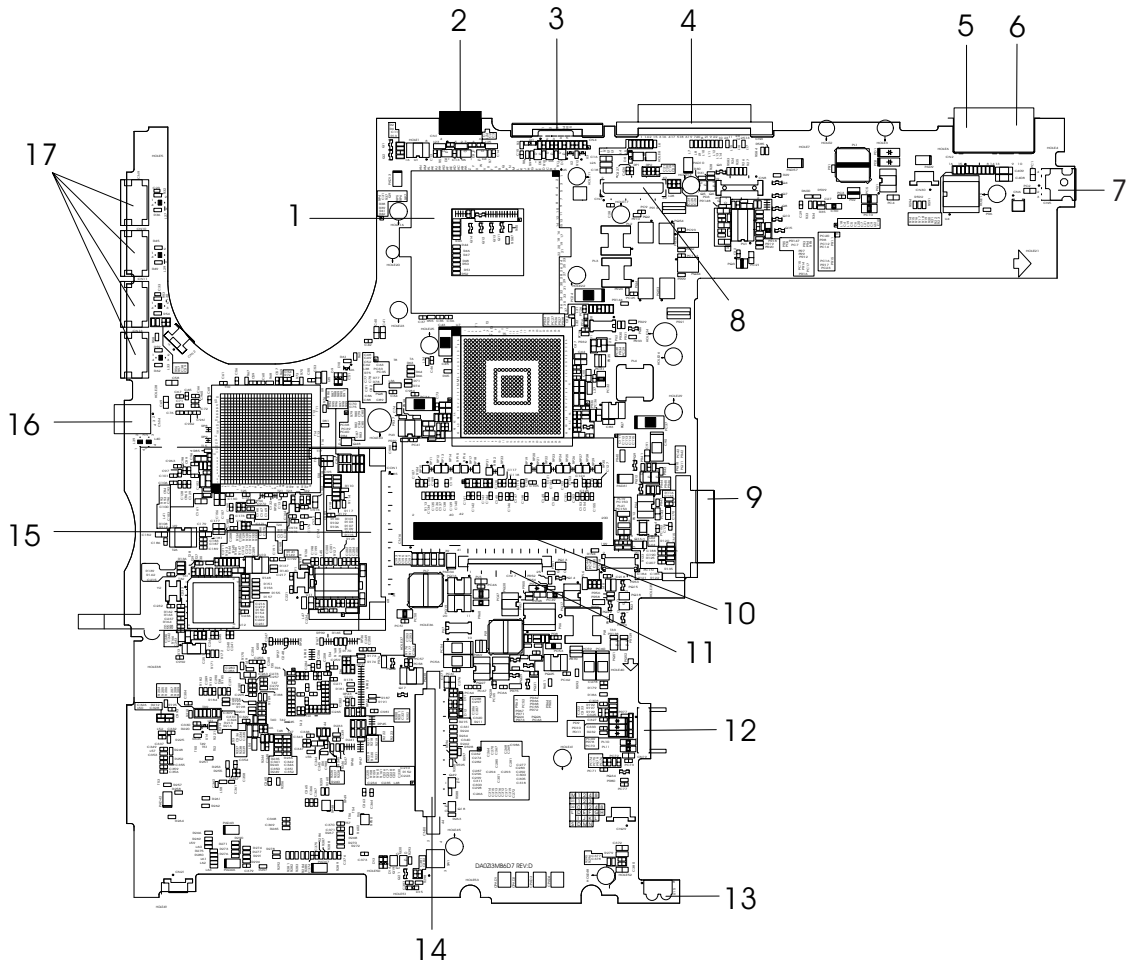

- | | | | |
|---|-------------------------|----|---------------------------|
| 1 | CPU socket | 10 | DIMM socket HDD connector |
| 2 | S-video port | 11 | Keyboard connector |
| 3 | CRT | 12 | Main battery connector |
| 4 | Docking | 13 | IR |
| 5 | RJ45 | 14 | HDD connector |
| 6 | RJ11 | 15 | PCMCIA slot |
| 7 | Power jack | 16 | IEEE 1394 port |
| 8 | LCD connector | 17 | Four USB ports |
| 9 | Optical drive connector | | |

Bottom View

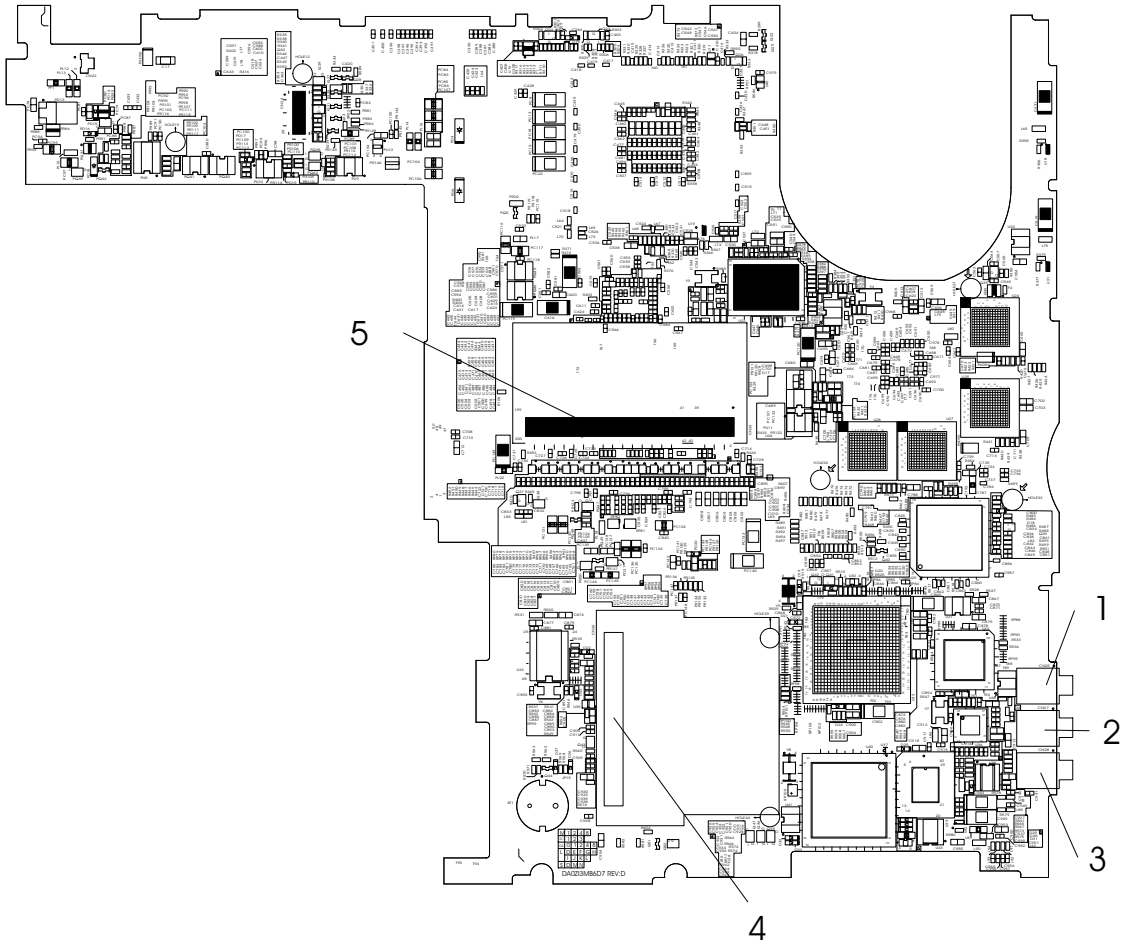

- 1 Line-in connector
- 2 Microphone-in connector
- 3 Line-out connector
- 4 Mini PCI connector
- 5 DIMM socket

Outlook View

A general introduction of ports allow you to connect peripheral devices, as you would with a desktop PC.

Front Open View



#	Icon	Item	Description
1		Display screen	Also called LCD (liquid-crystal display), displays computer output.
2		Power button	Turns on the computer.
3		Touchpad	Touch-sensitive pointing device which functions like a computer mouse.
4		Click buttons (left, center and right)	The left and right buttons function like the left and right mouse buttons; the center button serves as a 4-way scroll button.
5		Palmrest	Comfortable support area for your hands when you use the computer.
6		Keyboard	Inputs data into your computer.
7		Status indicators	LEDs (light-emitting diode) that turn on and off to show the status of the computer, its functions and components.
8		Microphone	Internal microphone for sound recording.
9		Launch keys	Special keys for launching Internet browser, E-mail program and frequently used programs. Located at the top of the keyboard are five buttons. They are designated as P1, P2, P3, E-mail button and Web browser button. P1, P2 and P3 launch user-programmable applications; E-mail and Web browser launch E-mail and Internet browser applications.

Front Panel

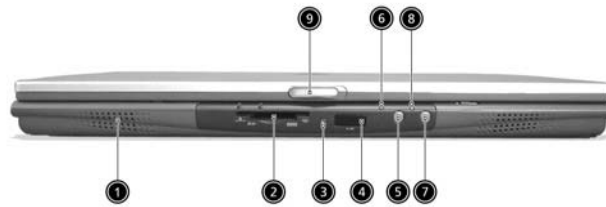







#	Icon	Item	Description
1		Speaker	Outputs sound.
2		4-in-1 memory reader ¹	Reads cards from Smart Media, Memory Stick, MultiMedia, and Secure Digital cards.
3		4-in-1 status indicator ¹	Displays activity of 4-in-1 memory reader.
4		Infrared port	Interfaces with infrared devices (e.g., infrared printer, IR-aware computer).
5		Bluetooth button ²	Starts Bluetooth functionality.
6		Bluetooth indicator ²	Indicates that (optional) Bluetooth is enabled.
7		InviLink button ³	Enables or disables wireless connectivity.
8		InviLink indicator ³	Indicates status of wireless communication
9		Latch	Latch for opening and closing the laptop.

NOTE:

1. Four-in-one card reader is manufacturing option, subject to configuration. Only one card can operate at any given time.
2. Bluetooth button and indicator work on models with Bluetooth only.
3. InviLink button and indicator work on models with wireless LAN only.

Left Panel



#	Icon	Item	Description
1		Four (4) USB ports	Connect to Universal Serial Bus devices (e.g., USB mouse, USB camera).
2		IEEE 1394 port	Connects to IEEE 1394 devices.
3		PC Card slot	The slot supports a standard Type II CardBus PC Card.
4		PC Card eject button	Ejects the PC Card from the slot.
5		Line-in jack	Accepts audio line-in devices (e.g., audio CD player, stereo walkman).
6		Microphone jack	Accepts input from external microphone.
7		Headphone/Speaker/Line-out jack	Connects to headphones or other line-out audio devices (speakers).







Right Panel



#	Icon	Item	Description
1		Optical drive	Depending on your model, the optical drive is one of the following: DVD-ROM drive for reading CDs and DVDS. DVD/CD-RW combo drive for reading CDs and DVDs and writing to CD-RWs. DVD dual for reading both DVD+/- RWs and writing to DVD+/- RWs.
2		Optical disc access indicator	LED that indicates when an optical disc is being read or written.
3		Optical drive eject button	Press the eject button to remove a disc from the optical drive.
4		Optical drive emergency eject hole	Used to eject an optical disc when the computer is turned off.
5		Power jack	Connects to an AC adapter.

Rear Panel



#	Icon	Item	Description
1		Modem jack	Connects to a phone line.
2		Network jack	Connect to an Ethernet 10/100-based network.
3		Parallel port	Connects to a parallel device (e.g., parallel printer).
4		External display port	Connects to a display device (e.g., external monitor, LCD projector).
5		S-video	Connects to a television or display device with S-video input.
6		Security keylock	Connects to a Kensington-compatible computer security lock.

Bottom Panel

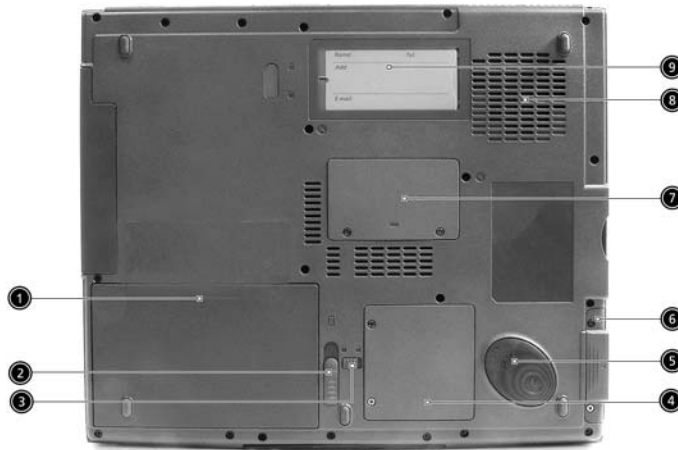





#	Icon	Item	Description
1		Battery bay	Houses the computer's battery pack.
2		Battery release latch	Unlatches the battery to remove the battery pack.
3		Battery lock	Locks the battery in place.
4		Mini-PCI slot	Slot for adding mini-PCI cards.
5		Hard disk protector	Protects the hard disk from accidental bumps and vibration.
6		Hard disk bay	Houses the computer's hard disk (secured by a screw).
7		Memory compartment	Houses th computer's main memory.
8		Cooling fan	Helps keep the computer cool. Note: Don't cover or obstruct the opening of the fan.
9		Personal identification slot	Insert a business card or similar-sized indentification card to presonalize your computer.

Indicators

The computer has three easy-to-read status indicators below the display screen. And two on the front of the computer.



The Power and Battery status indicators are visible even when the display is closed..

Icon	Function	Description
	Caps lock	Lights when Caps Lock is activated.
	Num lock	Lights when Num Lock is activated.
	Media Activity	Lights when the disc or optical drive is activated.
	Power	Lights gree when the power is on and orange when the computer is in standby mode.
	Battery	Lights orange when the battery is charging.



Using the Keyboard

The full-sized keyboard includes an embedded numeric keypad, separate cursor keys, two Windows keys and twelve function keys.

Lock Keys

The keyboard has three lock keys which you can toggle on and off.



Lock Key	Description
Caps Lock	When Caps Lock is on, all alphabetic characters are typed in uppercase. Toggle on and off by pressing the Caps Lock key on the left of the keyboard.
Num lock (Fn-F11)	When Num Lock is on, the embedded numeric keypad can be used. Toggle on and off by pressing the Fn + F11 keys simultaneously.
Scroll lock (Fn-F12)	When Scroll Lock is on, the screen moves one line up or down when you press  and  respectively.

Embedded Numeric Keypad

The embedded numeric keypad functions like a desktop numeric keypad. It is indicated by small characters located on the upper right corner of the keycaps. To simplify the keyboard legend, cursor-control key symbols are not printed on the keys.

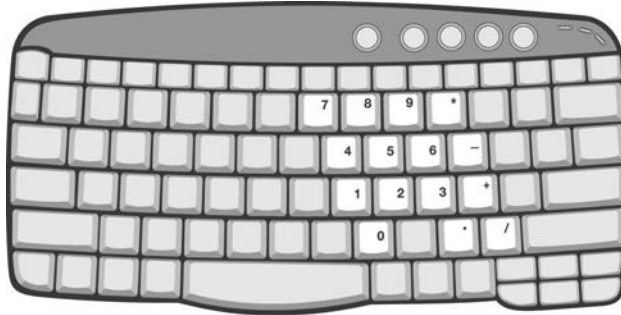



Desired Access	Num Lock On	Num Lock Off
Number keys on embedded keypad	Type numbers in a normal manner.	
Cursor-control keys on embedded keypad	Hold  while using cursor-control keys.	Hold Fn while using cursor-control keys.
Main keyboard keys	Hold Fn while typing letters on embedded keypad.	Type the letters in a normal manner.

Windows Keys

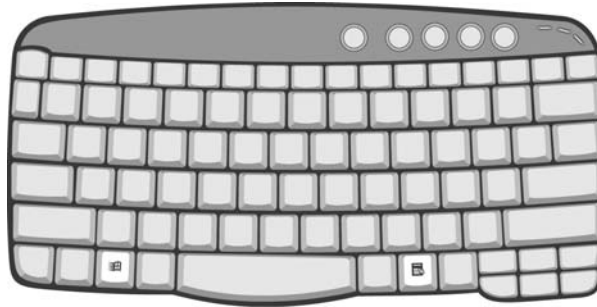
The keyboard has two keys that perform Windows-specific functions.



Key	Icon	Description
Windows logo key		Start button. Combinations with this key perform special functions. Below are a few examples: + Tab (Activates next taskbar button) + E (Explores My Computer) + F (Finds Document) + M (Minimizes All)  + Windows logo key + M (Undoes Minimize All) + R (Displays the Run... dialog box)
Application key		Opens a context menu (same as a right-click).





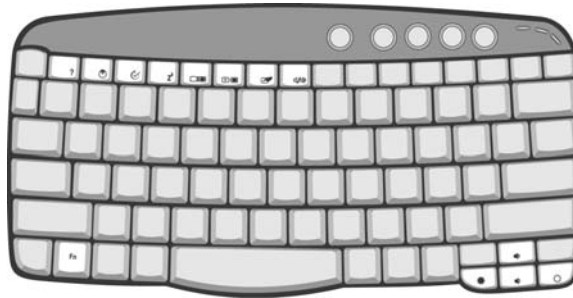

Hot Keys

Using the Fn key with another key creates a hot key, providing a quick and convenient method for controlling various functions.

To activate hot keys, first hold down the Fn key. Next, press the second key in the combination. Finally, release both keys.



Hot Key	Icon	Function	Description
Fn-F1	?	Hot key help	Displays help on hot keys.
Fn-F2		Setup	Accesses the computer's configuration utility.
Fn-F3		Power management scheme toggle	Switches the power management scheme used by the computer (function available if supported by operating system).
Fn-F4	Z ^z	Sleep	Puts the computer in Sleep mode.
Fn-F5		Display toggle	Switches display output between the display screen, external monitor (if connected) and both the display screen and external monitor.
Fn-F6		Screen blank	Turns the display screen backlight off to save power. Press any key to return.
Fn-F7		Touchpad toggle	Turns the internal touchpad on and off.
Fn-F8		Speaker toggle	Turns the speakers on and off.
Fn-F9		Volume up	Increases the speaker volume.

Hot Key	Icon	Function	Description
Fn- 		Volume down	Decreases the speaker volume.
Fn- 		Brightness up	Increases the screen brightness.
Fn- 		Brightness down	Decreases the screen brightness

The Euro Symbol

If your keyboard layout is set to United States-International or United Kingdom or if you have a keyboard with a European layout, you can type the Euro symbol on your keyboard.



NOTE: For US keyboard users: The keyboard layout is set when you first set up Windows. For the Euro symbol to work, the keyboard layout has to be set to United States-International.

To verify the keyboard type in Windows XP, follow the steps below:

1. Click on **Start, Control Panel**.
2. Double-click on **Regional and Language Options**.
3. Click on the **Language** tab and click on **Details**.
4. Verify that the keyboard layout used for "En English (United States)" is set to United States-International. If not, select and click on **ADD**; then select **United States-International** and click on **OK**.
5. Click on **OK**.

To type the Euro symbol:

1. Locate the Euro symbol on your keyboard.
2. Open a text editor or word processor.
3. Hold **Alt Gr** and press the Euro symbol.

NOTE: Some fonts and software do not support the Euro symbol. Please refer to www.microsoft.com/typography/faq/faq12.htm for more information.

Launch Keys

Located at the top of keyboard are five buttons. The left-most button is the power button. To the right of the power button are the four launch keys. They are designated as the mail button, the web browser button, and two programmable buttons (P1 and P2).



NOTE: To the left of these five launch keys is the wireless communication button. This wireless communication button works for model with 802.11b wireless LAN only.

Launch Key	Default application
Mail	Email application
Web browser	Internet browser application
P1	User-programmable
P2	User-programmable

E-mail Detection

Click right button at the Launch Manager icon on the taskbar and click on E-mail Detection. In this dialog box, you have the option to enable/disable mail checking, set the time interval for mail checking, etc. If you already have an email account, you can fill in User Name, Password and POP3 Server in the dialog box. The POP3 Server is the mail server where you get your email.

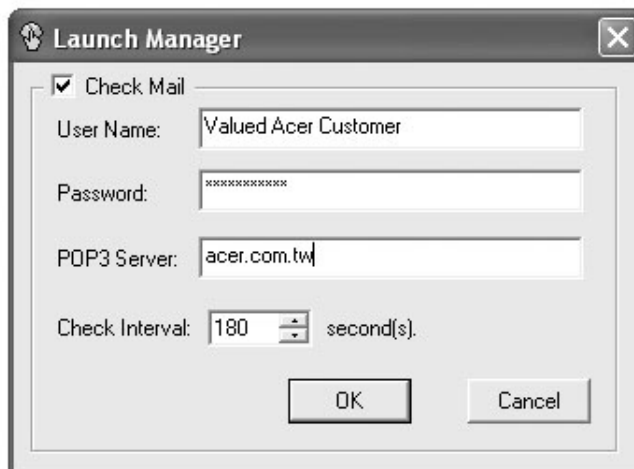

Touchpad

The built-in touchpad is a pointing device that senses movement on its surface. This means the cursor responds as you move your finger on the surface of the touchpad. The central location on the palmrest provides optimal comfort and support.



NOTE: If you are using an external USB mouse, you can press **Fn-F7** to disable the touchpad.

Touchpad Basics

The following items teach you how to use the touchpad:



- ❑ Move your finger across the touchpad to move the cursor.
- ❑ Press the left (1) and right (3) buttons located on the edge of the touchpad to do selection and execution functions. These two buttons are similar to the left and right buttons on a mouse. Tapping on the touchpad produces similar results.
- ❑ Use the 4-way scroll (2) button (top/bottom/left/and right) to scroll a page up, down, left or right. This button mimics your cursor pressing on the vertical and horizontal scroll bars of Windows applications.

Function	Left Button	Right Button	Scroll Button	Tap
Execute	Click twice quickly			Tap twice (at the same speed as double-clicking the mouse button)
Select	Click once			Tap once
Drag	Click and hold, then use finger to drag the cursor on the touchpad			Tap twice (at the same speed as double-clicking a mouse button) then hold finger to the touchpad on the second tap to drag the cursor
Access context menu		Click once		

Function	Left Button	Right Button	Scroll Button	Tap
Scroll			Click and hold the button in the desired direction (up/down/left/right)	

NOTE: Keep your fingers dry and clean when using the touchpad. Also keep the touchpad dry and clean. The touchpad is sensitive to finger movements. Hence, the lighter the touch, the better the response. Tapping too hard will not increase the touchpad's responsiveness.

Hardware Specifications and Configurations

Processor

Item	Specification
CPU type	AMD Athlon™ XP-M processor 2500+ and higher
CPU package	OPGA package
CPU core voltage	1.60V/1.65V

BIOS

Item	Specification
BIOS vendor	Phneoix
BIOS Version	V1.00
BIOS ROM type	Flash ROM
BIOS ROM size	512KB
BIOS package	PLCC
Supported protocols	ACPI 1.0b, PC Card 95, SM BIOS 2.3, EPP/IEEE 1284, ECP/IEEE 1284 1.7 & 1.9, PCI 2.2, PnP 1.0a, DMI 2.0, PS/2 keyboard and mouse, USB 2.0, VGA BIOS, CD-ROM bootable, IEEE 1394
BIOS password control	Set by setup manual

Second Level Cache

Item	Specification
Cache controller	Built-in CPU
Cache size	512KB
1st level cache control	Always enabled
2st level cache control	Always enabled
Cache scheme control	Fixed in write-back

System Memory

Item	Specification
Memory controller	AMD Athlon™ XP-M built-in
Memory size	0MB (no on-board memory)
DIMM socket number	2 sockets
Supports memory size per socket	1024MB
Supports maximum memory size	2048MB (by two 1024MB SO-DIMM module)
Supports DIMM type	DDR Synchronous DRAM
Supports DIMM Speed	333 MHz
Supports DIMM voltage	2.5V
Supports DIMM package	200-pin soDIMM
Memory module combinations	You can install memory modules in any combinations as long as they match the above specifications.

Memory Combinations

Slot 1	Slot 2	Total Memory
0MB	256MB	256MB
0MB	512MB	512MB
0MB	1024MB	1024MB
256MB	256MB	512MB
256MB	512MB	768MB
256MB	1024MB	1280MB
512MB	256MB	768MB
512MB	512MB	1024MB
512MB	1024MB	1536MB
1024MB	256MB	1280MB
1024MB	512MB	1536MB
1024MB	1024MB	2048MB

NOTE: Above table lists some system memory configurations. You may combine DIMMs with various capacities to form other combinations. On above table, the configuration of slot 1 and slot 2 could be reversed.

LAN Interface

Item	Specification
Chipset	VT6103
Supports LAN protocol	10/100 Mbps
LAN connector type	RJ45
LAN connector location	Rear panel

Modem Interface

Item	Specification
Chipset	South bridge/VIA VT8235
Data modem data baud rate (bps)	56K
Supports modem protocol	V.92 MDC
Modem connector type	RJ11
Modem connector location	Rear panel

Bluetooth-MODEM Interface

Item	Specification
Chipset	South bridge/VIA VT8235
Data throughput	200k bps (Blue-tooth)/56K bps (MODEM)
Protocol	Blue-tooth 1.1
Interface	USB 1.1+MDC
Connector type	RJ11 (MODEM)

Wireless Module 802.11g (optional device)

Item	Specification
Chipset	BCM4306KFB
Data throughput	11M bps
Protocol	802.11g

Wireless Module 802.11g (optional device)

Item	Specification
Interface	Mini-PCI type II

Four-in-One Card Reader

Item	Specification
Chipset	M220V0315
Data throughput	USB 1.1
Protocol	SMC, MS, MMC, and SD

Hard Disc Drive Interface

Item			
Vendor & Model Name	HGST MORAGA IC25N030ATMR04 TOSHIBA MK3021GAS	HGST MORAGA IC25N040ATMR04 TOSHIBA MK4025GAS	HGST MORAGA IC25N060ATMR04 TOSHIBA MK6021GAS
Capacity (MB)	30000	40000	60000
Bytes per sector	512	512	512
Data heads	2	2 for HGST 3 for TOSHIBA	3 for HGST 4 for TOSHIBA
Drive Format			
Disks	1	1 for HGST 2 for TOSHIBA	2
Spindle speed (RPM)	4200 RPM	4200 RPM	4200 RPM
Performance Specifications			
Buffer size	2048KB	2048KB	2048KB
Interface	ATA/ATAPI-6 ATA-5	ATA/ATAPI-6 ATA-5	ATA/ATAPI-6 ATA-5
Max. media transfer rate (disk-buffer, Mbytes/s)	350 for HGST 317 for TOSHIBA	350 for HGST 317 for TOSHIBA	350 for HGST 317 for TOSHIBA
Data transfer rate (host-buffer, Mbytes/s)	100 MB/Sec. Ultra DMA mode-5	100 MB/Sec. Ultra DMA mode-5	100 MB/Sec. Ultra DMA mode-5
DC Power Requirements			
Voltage tolerance	5V(DC) +/- 5%	5V(DC) +/- 5%	5V(DC) +/- 5%

DVD Interface

Item	Specification	
Vendor & model name	MKE SR-8177/QSI SDR083	
Performance Specification	With CD Diskette	With DVD Diskette
Transfer rate (KB/sec)	Sustained: Max 3.6Mbytes/sec	Sustained: Max 11.08Mbytes/sec for MKE Max 10.56Mbytes/sec for QSI

DVD Interface

Item	Specification
Data Buffer Capacity	256 KBytes for MKE
Interface	IDE/ATAPI (compliant to ATA/ATAPI-5)
Applicable disc format	KME- DVD: DVD-ROM (DVD-5, DVD-9, DVD-10), DVD-R (3.95G/4.7G), DVD-RAM (2.6G/4.7G), DVD-RW CD: CD-Audio, CD-ROM (mode 1 and mode 2), CD-ROM XA (mode 2, form 1 and form 2), CD-I (mode 2, form 1 and form 2), CD-I Ready, CD-I Bridge, CD-WO, CD-RW, Photo CD, Video CD Enhanced Music CD (CD Plus) CD-TEXT
	QSI- DVD: DVD-ROM (DVD-5, DVD-9, DVD-10, DVD-18), DVD-R, DVD+R, DVD-RW, DVD+RW CD: CD-DA, CD-ROM/XA, CD-i, Karaoke CD, Video CD, Multi-session Photo CD, Enhanced CD, i-trax CD, CD extra, CD Plus, CD-Text, CD-R and CD-RW
Loading mechanism	Load: Manual Release: (a) Electrical Release (Eject Button) (b) Release by ATAPI command (c) Emergency Release
Power Requirement	
Input Voltage	5 V +/- 5 % (Operating)

DVD Combo Interface

Item	Specification	
Vendor & model name	QSI SBW-242/LiteOn LSC-24082K	
Performance Specification	With CD Diskette	With DVD Diskette
Transfer rate (Mbytes/sec)	Sustained: Max 3.6Mbytes/sec for QSI Max 3.5Mbytes/sec for LiteOn	Sustained: Max 10.56Mbytes/sec for QSI Max 10.15Mbytes/sec for LiteOn
Data Buffer Capacity	2MB	
Interface	IDE/ATAPI-5	
Applicable disc format	QSI- DVD: DVD-ROM (DVD-5, DVD-9, DVD-10, DVD-18), DVD-R, DVD-RW, DVD+R, DVD+RW, DVD-ROM (optional) CD: CD-DA, CD-ROM/XA, CD-i, Karaoke CD, Video CD, Multi-session Photo CD, Enhanced CD, i-trax CD, CD extra, CD Plus, CD-Text, CD-R and CD-RW	
	LiteOn- DVD: DVD single/dual layer (PTP, OTP), DVD-R (3.8G/4.7G), DVD-R multi-borders, DVD+R, DVD+R multi-sessions, DVD-RW and DVD+RW CD: CD-DA, CD-ROM, CD-ROM/XA, Photo-CD, Multi-session, Karaoke-CD, Video-CD, CD-I FMV, CD Extra, CD Plus, CD-R, CD-RW	
Loading mechanism	Load: Manual Release: (a) Electrical Release (Eject Button) (b) Release by ATAPI command (c) Emergency Release	
Power Requirement		
Input Voltage	5 V +/- 5 % (Operating)	

Audio Interface

Item	Specification
Audio Controller	Realtek ALC202
Audio onboard or optional	Built-in

Audio Interface

Item	Specification
Mono or Stereo	Stereo
Resolution	20 bit stereo Digital to analog converter 18 bit stereo Analog to Ditial converter
Compatibility	AC97
Mixed sound source	Line-in, CD
Voice channel	8/16-bit, mono/stereo
Sampling rate	44,1 KHz (48K byte for AC97 interface)
Internal microphone	Yes
Internal speaker / Quantity	Yes/2
Supports PnP IRQ	IRQ10

Speakers

Item	Specification
Number of speaker	2
Rating	1W, max; 4 ohm
Connector type	Headphone out, microphone in and line-in

Video Interface

Item	Specification
Chipset	ATI M9+X
Package Specifications	Package, Size: 650 BGA, 31mm x 31mm
Supports ZV (Zoomed Video) port	No
Resolution Support	Max 2D/3D resolution: 2048x1536 Max color depth: 16.7M Colors LVDS, TMDS, TV-out: 2048x1536, 1600x1200, 1024x768
Bus Specifications	AGP bus support / PCI bus support: AGP 2X (3.3V) / 4X (1.5V) / PCI 2.2
Memory Type	Samsung 4MBx32 DDR SDRAM
VGA Ram Size	128MB

Parallel Port

Item	Specification
Parallel port controller	PC87393
Number of parallel port	1
Location	Rear side
Connector type	25-pin D-SUB
Parallel port function control	Enable/Disable/Auto (BIOS or operating system chooses configuration) by BIOS Setup Note: Depending on your operating system, disabling an unused device may help free system resources for other devices.
Supports ECP/EPP/Bi-directional/Output only (PS/2 compatible)	Yes (set by BIOS setup) Note: When Mode is selected as EPP mode, "3BCh" will not be available.
Optional ECP DMA channel (in BIOS Setup)	DMA channel 3
Optional parallel port I/O address (in BIOS Setup)	378h, 278h, 3BCh

Parallel Port

Item	Specification
Optional parallel port IRQ (in BIOS Setup)	IRQ7, IRQ5

USB Port

Item	Specification
Chipset	VIA VT8235
USB Compliance Level	2.0
OHCI	USB 2.0
Number of USB port	4
Location	Left side
Serial port function control	Enable/Disable by BIOS Setup

IEEE 1394 Port

Item	Specification
Chipset	TI TSB43AB21
Interface USB Compliance Level	IEEE 1394 1.0
Number of IEEE 1394 port	1
Location	Left side
Connector type	IEEE 1394

PCMCIA Port

Item	Specification
PCMCIA controller	TI PCI1410
Supports card type	Type-II
Number of slots	One type-II
Access location	Left panel
Supports ZV (Zoomed Video) port	No ZV support
Supports 32 bit CardBus	Yes (IRQ10)

Smart Card Reader

Item	Specification
Chipset	PCMCIA chip built-in
Number of slot	1
Location	Front side

System Board Major Chips

Item	Controller
Core logic	VIA KN400 (AMD Athlon™ XP-M processor, VIA KN400+VIA VT8235)
VGA	ATI M9+X
LAN	VIA VT8235 embedded LAN controller + VT6103 LAN PHYceiver
IEEE 1394	TI TSB43AB21
USB 2.0	VIA VT8235 embedded USB controller

System Board Major Chips

Item	Controller
Super I/O controller	NS PC87393
MODEM	South bridge/VIA VT8235
Blue tooth	South bridge/VIA VT8235
Wireless 802.11g	BCM4306KFB
PCMCIA	TI PCI1410
Audio	RealTek ALC202
Four-in-one card reader	M220V0315
Touchpad	Synaptics TM41P-353
IR	Vishay TFU6102F

Keyboard

Item	Specification
Keyboard controller	NS 87570 C4
Keyboard vendor & model name	DARFON
Total number of keypads	84/85 key
Windows logo key	Yes
Internal & external keyboard work simultaneously	No Note: Internal and external keyboard can not work simultaneously by software specification.

Battery

Item	Specification
Vendor & model name	Simplo/Sanyo
Battery Type	Li-ion
Pack capacity	4400 Ah
Cell voltage	3.7V/cell
Number of battery cell	8
Package configuration	4 cells in series, 2 series in parallel
Package voltage	14.8V

LCD

Item			
Vendor & model name	AU B150XG01	HITACHI TX38D81VC	LG LP150X08
Mechanical Specifications			
LCD display area (diagonal, inch)	15.0	15.0	15.0
Display technology	TFT	TFT	TFT
Resolution	XGA (1024x768)	XGA (1024x768)	XGA (1024x768)
Supports colors	262K	262K	262K
Optical Specification			
Contrast ratio	300	100	175 (Min.) 250 (Typ.)
Response time(msec)	Rising: 24 (Typ.) 15 (Max.) Falling: 11 (Typ.) 30 (Max.)	Rising: 30 (Typ.) 50 (Max.) Falling: 30 (Typ.) 50 (Max.)	Rising: 10 (Typ.) 20 (Max.) Falling: 20 (Typ.) 30 (Max.)

LCD

Item			
Luminance, white, 5P (cd/m ²)	180 (5 points average)	180 (5 points average)	150 (5 points average)
Brightness control	keyboard hotkey	keyboard hotkey	keyboard hotkey
Contrast control	No	No	No
Electrical Specification			
Supply voltage for LCD display (V)	3.3	3.3	3.3

AC Adaptor

Item	Specification
Model number	LITE- ON PA-1900-05QA, 3pins LSE 0202C1990, 3pins
Input rating	90VAC to 264VAC, 47Hz to 63Hz
Output rating	75W, 19V (18.8V, min to 20V, max), 4A (0A, min to 4A, max)

System Power Management

ACPI mode	Power Management
Mech. Off (G3)	All devices in the system are turned off completely.
Soft Off (G2/S5)	OS initiated shutdown. All devices in the system are turned off completely.
Working (G0/S0)	Individual devices such as the CPU and hard disk may be power managed in this state.
Suspend to RAM (S3)	CPU set power down VGA Suspend PCMCIA Suspend Audio Power Down Hard Disk Power Down CD-ROM Power Down Super I/O Low Power mode
Save to Disk (S4)	Also called Hibernate state. System saves all system states and data onto the disk prior to power off the whole system.

Memory Address Map

Memory Address	Size	Function
00100000h-000F0000h	512 KB	System BIOS
000CFFFFh-000C0000h		VGA BIOS
00009FFFFh-00000000h	640KB	Conventional memory

I/O Address Map

I/O Address	Function
000-00F	DMA controller-1
020-021	Interrupt controller-1
040-043	Timer 1
060, 064	Keyboard controller 87570 chip select
061	System speaker

I/O Address Map

I/O Address	Function
000-00F	DMA controller-1
020-021	Interrupt controller-1
040-043	Timer 1
060, 064	Keyboard controller NS87591 chip select
070-073	Real-time clock and CMOS
0A0-0A1	Interrupt controller-2
0C0-0DF	DMA controller-2
066, 062	ACPI EC interface (NS87591)
170-177	Secondary IDE channel
1F0-1F7	Primary IDE channel
378, 37F	Parallel port
3B0-3BB 3C0-3DF	VGA I/O address
CF8-CFF	PCI configuration register
000-00F	DMA controller-1

IRQ Assignment Map

Interrupt Channel	Function(Hardware)
IRQ00	System timer
IRQ01	Keyboard
IRQ02	Programmable interrupt controller
IRQ03	IrDA Fast Infrared Port
IRQ04	Communication port (COM1)
IRQ05	Winbond SD controller
IRQ06	Standard floppy disk controller
IRQ07	ECP printer port (LPT1)
IRQ08	CMOS/RTC
IRQ09	SCI IRQ used by ACPI bus
IRQ12	PS/2 mouse
IRQ13	Numeric data processor
IRQ14	Primary IDE channel
IRQ15	Secondary IDE channel

DMA Channel Assignment

Item	Specification
Channel 1	IrDA Fast Infrared Port
Channel 3	ECP printer port
Channel 4	DMA controller

System Utilities

BIOS Setup Utility

The BIOS Setup Utility is a hardware configuration program built into your computer's BIOS (Basic Input/Output System).

Your computer is already properly configured and optimized, and you do not need to run this utility. However, if you encounter configuration problems, you may need to run Setup. Please also refer to Chapter 4 Troubleshooting when problem arises.

To activate the BIOS Utility, press **F2** during POST (when "Press <F2> to enter Setup" message is prompted on the bottom of screen).

Press **F2** to enter setup. Press <F12> during POST to enter multi-boot menu. In this menu, user can change boot device without entering BIOS SETUP Utility.

PhoenixBIOS Setup Utility					
Information	Main	Advanced	Security	Boot	Exit
CPU Type:	AMD Athlon XP-M				
CPU Speed:					
IDE1 Model Name:	None				
IDE1 Serial Number:	None				
System BIOS Ver:	Ferrari 3000_V1.00				
VGA BIOS Ver:	AT M7-P V0.2				
KBC Ver:	V1.00				
Serial Number:	xxxxxxxxxxxxxxxxxxxxxxxx			22 Byte	
Asset Tag Number:	N/A			32 Byte	
Product Name:	Ferrari 3000			16 Byte	
Manufacturer Name:	Acer			16 Byte	
UUID:	xxxxxxx-xxxx-xxxx-xxxx-xxxxxxxxxxxx			16 Byte	

F1 Help	↑↓ Select Item	F5/F6 Change Values	F9 Setup Defaults
Esc Exit	←→ Select Menu	Enter Select ▶ Sub-Menu	F10 Save and Exit

Navigating the BIOS Utility

There are six menu options: Info., Main, System Devices, Security, Boot, and Exit.

Follow these instructions:

- To choose a menu, use the cursor left/right keys (← →).
- To choose a parameter, use the cursor up/down keys (↑ ↓).
- To change the value of a parameter, press F8 or F6.
- A plus sign (+) indicates the item has sub-items. Press ENTER to expand this item.
- Press ESC while you are in any of the menu options to go to the Exit menu.
- In any menu, you can load default settings by pressing F8. You can also press F6 to save any changes made and exit the BIOS Setup Utility.

NOTE: You can change the value of a parameter if it is enclosed in square brackets. Navigation keys for a particular menu are shown on the bottom of the screen. Help for parameters are found in the Item Specific Help part of the screen. Read this carefully when making changes to parameter values.

This menu provides you the information of the system.

Info.

PhoenixBIOS Setup Utility					
Information	Main	Advanced	Security	Boot	Exit
CPU Type:	AMD Athlon XP-M				
CPU Speed:					
IDE1 Model Name:	None				
IDE1 Serial Number:	None				
System BIOS Ver:	Ferrari 3000_V1.00				
VGA BIOS Ver:	AT M7-P V0.2				
KBC Ver:	V1.00				
Serial Number:	xxxxxxxxxxxxxxxxxxxxxxxx				22 Byte
Asset Tag Number:	N/A				32 Byte
Product Name:	Ferrari 3000				16 Byte
Manufacturer Name:	Acer				16 Byte
UUID:	xxxxxxx-xxxx-xxxx-xxxx-xxxxxxxxxxxx				16 Byte

F1 Help	↑↓ Select Item	F5/F6 Change Values	F9 Setup Defaults
Esc Exit	←→ Select Menu	Enter Select ▶ Sub-Menu	F10 Save and Exit

Parameter	Description
Serial Number	This field displays the serial number of this unit.
UUID Number	UUID=32bytes

Main

The Main screen displays a summary of your computer hardware information, and also includes basic setup parameters. It allows the user to specify standard IBM PC AT system parameters.

PhoenixBIOS Setup Utility																																																	
Information	Main	Advanced	Security	Boot	Exit																																												
<table border="1"> <tr> <td colspan="2"></td> <td colspan="2">Item Specific Help</td> </tr> <tr> <td>System Time:</td> <td>[00:00:00]</td> <td colspan="2"></td> </tr> <tr> <td>System Date:</td> <td>[10/15/2003]</td> <td colspan="2"></td> </tr> <tr> <td>System Memory:</td> <td>640 KB</td> <td colspan="2">Shows system memory size</td> </tr> <tr> <td>Extended Memory:</td> <td>238 MB</td> <td colspan="2">Shows extended memory size</td> </tr> <tr> <td>VGA Memory:</td> <td>128MB</td> <td colspan="2">VGA memory size</td> </tr> <tr> <td>Quiet Boot:</td> <td>[Enabled]</td> <td colspan="2"></td> </tr> <tr> <td>Power on display:</td> <td>[Auto]</td> <td colspan="2"></td> </tr> <tr> <td>LCD Auto Dim:</td> <td>[Enabled]</td> <td colspan="2"></td> </tr> <tr> <td>Wakeup from LAN</td> <td>[Disabled]</td> <td colspan="2"></td> </tr> <tr> <td>F12 Boot Menu</td> <td>[Disabled]</td> <td colspan="2"></td> </tr> </table>							Item Specific Help		System Time:	[00:00:00]			System Date:	[10/15/2003]			System Memory:	640 KB	Shows system memory size		Extended Memory:	238 MB	Shows extended memory size		VGA Memory:	128MB	VGA memory size		Quiet Boot:	[Enabled]			Power on display:	[Auto]			LCD Auto Dim:	[Enabled]			Wakeup from LAN	[Disabled]			F12 Boot Menu	[Disabled]			<p><Tab>, <Shift-Tab>, or <Enter> selects field.</p>
		Item Specific Help																																															
System Time:	[00:00:00]																																																
System Date:	[10/15/2003]																																																
System Memory:	640 KB	Shows system memory size																																															
Extended Memory:	238 MB	Shows extended memory size																																															
VGA Memory:	128MB	VGA memory size																																															
Quiet Boot:	[Enabled]																																																
Power on display:	[Auto]																																																
LCD Auto Dim:	[Enabled]																																																
Wakeup from LAN	[Disabled]																																																
F12 Boot Menu	[Disabled]																																																
<table border="1"> <tr> <td>F1 Help</td> <td>↑↓ Select Item</td> <td>F5/F6 Change Values</td> <td>F9 Setup Defaults</td> </tr> <tr> <td>Esc Exit</td> <td>←→ Select Menu</td> <td>Enter Select</td> <td>▶ Sub-Menu</td> </tr> <tr> <td colspan="4">F10 Save and Exit</td> </tr> </table>				F1 Help	↑↓ Select Item	F5/F6 Change Values	F9 Setup Defaults	Esc Exit	←→ Select Menu	Enter Select	▶ Sub-Menu	F10 Save and Exit																																					
F1 Help	↑↓ Select Item	F5/F6 Change Values	F9 Setup Defaults																																														
Esc Exit	←→ Select Menu	Enter Select	▶ Sub-Menu																																														
F10 Save and Exit																																																	

NOTE: The screen above is for reference only. Actual values may differ.

The table below describes the parameters in this screen. Settings in **boldface** are the default and suggested parameter settings.

Parameter	Description	Format/Option
System Time	Sets the system time.	Format: HH:MM:SS (hour:minute:second) System Time
System Date	Sets the system date.	Format MM/DD/YYYY (month/day/year) System Date
System Memory	This field reports the memory size of the system. Memory size is fixed to 640MB	
Extended Memory	This field reports the memory size of the extended memory in the system. Extended Memory size=Total memory size-1MB	
Video Memory	Shows the VGA memory size. The default value is set to 32MB	Option: 32 /64MB
Quiet Boot	Determines if Customer Logo will be displayed or not; shows Summary Screen is disabled or enabled. Enabled: Customer Logo is displayed, and Summary Screen is disabled. Disabled: Customer Logo is not displayed, and Summary Screen is enabled.	Option: Enabled or Disabled
Power on display	Auto: During power process, the system will detect if any display device is connected on external video port. If any external display device is connected, the power on display will be in CRT (or projector) only mode. Otherwise it will be in LCD only mode. Both: Simultaneously enable both the integrated LCD screen and the system's external video port (for an external CRT or projector).	Option: Auto or Both
LCD Auto Dim	Determines if the system will automatically dim the LCD brightness in order to save power when AC is not present.	Option: Enabled or Disabled

NOTE: The sub-items under each device will not be shown if the device control is set to disable or auto. This is because the user is not allowed to control the settings in these cases.

Advanced

The Advanced menu screen contains parameters involving your hardware devices. It also provides advanced settings of the system.

PhoenixBIOS Setup Utility		
Information	Main	Advanced
Parallel port:	[Enabled]	Item Specific Help
Mode:	[Bi-direct]	Configure Infrared Port using options: [Auto] Disable the touchpad if an external PS/2 mouse is connected. Otherwise enable the touchpad [Both] The touchpad is always enabled. Any external PS/2 mouse connected will be enabled at the same time.
Base I/O address:	[378]	
Interrupt:	[IRQ 7]	
DMA channel	[DMA3]	

F1 Help	↑ ↓ Select Item	F5/F6 Change Values	F9 Setup Defaults
Esc Exit	← → Select Menu	Enter Select ▶ Sub-Menu	F10 Save and Exit

The table below describes the parameters in the screen. Settings in **boldface** are the default and suggested parameter settings.

Parameter	Description	Options
Serial Port	Enables, disables or auto detects the serial port.	Enabled /Disabled/Auto
Parallel Port	Enables, disables or auto detects the parallel port.	Enabled /Disabled/Auto
Mode	Sets the operation mode of the parallel port.	ECP , EPP, Normal or Bi-directional
Base I/O address	Sets the I/O address of the parallel port. This parameter is enabled only if Mode is set to ECP or Bi-directional. This parameter is enabled only if Mode is set to ECP.	378h /278h/3BCH
Interrupt	Sets the interrupt request of the parallel port.	IRQ7 /IRQ5
DMA channel	Sets a DMA channel for the printer to operate in ECP mode. This parameter is enabled only if Mode is set to ECP.	DMA3 /DMA1

Parameter	Description	Options
Internal Touchpad	Determines whether or not to disable the internal pointing device as the PS/2 mouse is connected.	Both or Auto
Infrared Port (FIR)	Enables, disables or auto detects the infrared port.	Disabled/Enabled Disabled/Auto

Security

The Security screen contains parameters that help safeguard and protect your computer from unauthorized use.

PhoenixBIOS Setup Utility					
Information	Main	Advanced	Security	Boot	Exit
				Item Specific Help	
User Password is		Clear		Supervisor Password controls accesses of the whole setup utility. It can be used to boot up when Password on boot is enabled.	
Supervisor Password is		Clear			
Primary HardDisk Security		Clear			
Set User Password		[Enter]			
Set Supervisor Password		[Enter]			
Set HDD Password		[Enter]			
Password on boot:		[Enabled]			

F1 Help	↑↓ Select Item	F5/F6 Change Values	F9 Setup Defaults
Esc Exit	←→ Select Menu	Enter Select ▶ Sub-Menu	F10 Save and Exit

The table below describes the parameters in this screen. Settings in **boldface** are the default and suggested parameter settings.

Parameter	Description	Option
User Password is	Shows the setting of the user password.	Clear or Set
Supervisor Password is	Shows the setting of the Supervisor password	Clear or Set
Primary Harddisk Security	This feature is available to user when Supervisor password is set. Password can be written on HDD only when Supervisor password or user password is set and password on HDD is set to enabled. Supervisor Password is written to HDD only when Supervisor password is being set. User password is written to HDD when both passwords are set. When both Supervisor and user password are present, both passwords can unlock the HDD.	Disabled or Enabled
Set User Password	Press Enter to set the user password. When set, this password protects the BIOS Setup Utility from unauthorized access.	
Set Supervisor Password	Press Enter to set the supervisor password. When set, this password protects the BIOS Setup Utility from unauthorized access.	
Password on Boot	Defines whether a password is required or not while the events defined in this group happened. The following sub-options are all requires the Supervisor password for changes and should be grayed out if the user password was used to enter setup.	Disabled or Enabled

NOTE: When you are prompted to enter a password, you have three tries before the system halts. Don't forget your password. If you forget your password, you may have to return your notebook computer to your dealer to reset it.

Setting a Password

Follow these steps as you set the user or the supervisor password:

1. Use the **↑** and **↓** keys to highlight the Set Supervisor Password parameter and press the **ENTER** key. The Set Supervisor Password box appears:

Set Supervisor Password

Enter New Password []

Confirm New Password []

2. Type a password in the "Enter New Password" field. The password length can not exceeds 8 alphanumeric characters (A-Z, a-z, 0-9, not case sensitive). Retype the password in the "Confirm New Password" field.

IMPORTANT: Be very careful when typing your password because the characters do not appear on the screen.

3. Press **ENTER**.
After setting the password, the computer sets the User Password parameter to "Set".
4. If desired, you can opt to enable the Password on boot parameter.
5. When you are done, press **F10** to save the changes and exit the BIOS Setup Utility.

Removing a Password

Follow these steps:

1. Use the **↑** and **↓** keys to highlight the Set Supervisor Password parameter and press the **ENTER** key. The Set Password box appears:

Set Supervisor Password

Enter current password []

Enter New Password []

Confirm New Password []

2. Type the current password in the Enter Current Password field and press **ENTER**.
3. Press **ENTER** twice **without** typing anything in the Enter New Password and Confirm New Password fields. The computer then sets the Supervisor Password parameter to “Clear”.
4. When you have changed the settings, press **F10** to save the changes and exit the BIOS Setup Utility.

Changing a Password

1. Use the **↑** and **↓** keys to highlight the Set Supervisor Password parameter and press the **ENTER** key. The Set Password box appears:

Set Supervisor Password

Enter current password []

Enter New Password []

Confirm New Password []

2. Type the current password in the Enter Current Password field and press **ENTER**.
3. Type a password in the Enter New Password field. Retype the password in the Confirm New Password field.
4. Press **ENTER**. After setting the password, the computer sets the User Password parameter to “Set”.
5. If desired, you can enable the Password on boot parameter.
6. When you are done, press **F10** to save the changes and exit the BIOS Setup Utility.

If the verification is OK, the screen will display as following.

Setup Notice

Changes have been saved.

[continue]

The password setting is complete after the user presses **F10**.

If the current password entered does not match the actual current password, the screen will show you the Setup Warning.

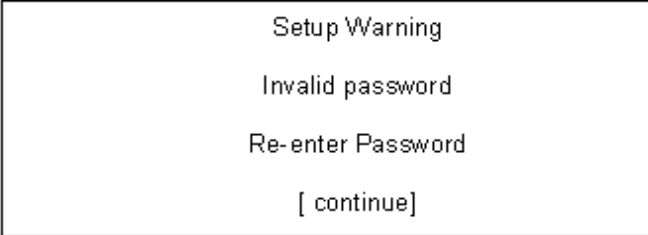

Setup Warning
Invalid password
Re-enter Password
[continue]

A rectangular dialog box with a black border containing four lines of text centered horizontally.

If the new password and confirm new password strings do not match, the screen will display the following message.

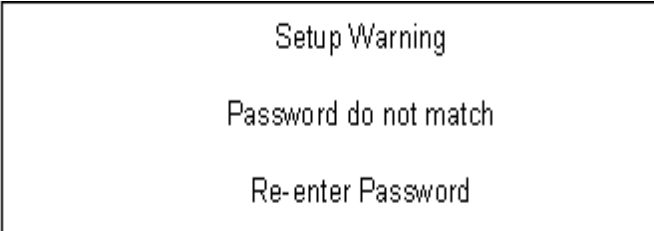

Setup Warning
Password do not match
Re-enter Password

A rectangular dialog box with a black border containing three lines of text centered horizontally.

Boot

This menu allows the user to decide the order of boot devices to load the operating system. Bootable devices includes the distette drive in module bay, the onboard hard disk drive and the CD-ROM in module bay.

PhoenixBIOS Setup Utility					
Information	Main	Advanced	Security	Boot	Exit
<div style="border: 1px solid black; padding: 10px;"> <p>+Hard Drive</p> <p>+Floppy Devices</p> <p>CD-ROM Drive</p> <p>Boot to LAN</p> </div>				<div style="border: 1px solid black; padding: 10px;"> <p>Item Specific Help</p> <p>Keys used to view or configure devices: <Enter> expnads or Collapses Devices with a + or -</p> <p><Ctrl+Enter> expnads all</p> <p><Shift + 1> enables or disables a device.</p> <p><+> and <-> moves the device up or down.</p> <p><n> May move removable device between Hard Disk or Removable Disk.</p> <p><d> Remove a device that is not installed.</p> </div>	
<p>F1 Help ↑↓ Select Item</p> <p>Esc Exit ←→ Select Menu</p>		<p>F5/F6 Change Values</p> <p>Enter Select ▶ Sub-Menu</p>		<p>F9 Setup Defaults</p> <p>F10 Save and Exit</p>	

Exit

The Exit screen contains parameters that help safeguard and protect your computer from unauthorized use.

PhoenixBIOS Setup Utility		
Information	Main	Advanced
		Security
		Boot
		Exit

<p>Exit Saving Changes</p> <p>Exit Discarding Changes</p> <p>Load Setup Defaults</p> <p>Discard Changes</p> <p>Save Changes</p>	<p>Item Specific Help</p> <p>Exit System Setup and save your changes to CMOS.</p>
---	---

F1 Help	↑↓ Select Item	F5/F6 Change Values	F9 Setup Defaults
Esc Exit	←→ Select Menu	Enter Select ▶ Sub-Menu	F10 Save and Exit

The table below describes the parameters in this screen.

Parameter	Description
Exit Saving Changes	Exit System Setup and save your changes to CMOS.
Exit Discarding Changes	Exit utility without saving setup data to CMOS.
Load Setup Default	Load default values for all SETUP item.
Discard Changes	Load previous values from CMOS for all SETUP items.
Save Changes	Save Setup Data to CMOS.

BIOS Flash Utility

The BIOS flash memory update is required for the following conditions:

- New versions of system programs
- New features or options
- Restore a BIOS when it becomes corrupted.

Use the Phlash utility to update the system BIOS flash ROM.

NOTE: If you do not have a crisis recovery diskette at hand, then you should create a **Crisis Recovery Diskette** before you use the Phlash utility.

NOTE: Do not install memory-related drivers (XMS, EMS, DPMS) when you use the Phlash.

NOTE: Please use the AC adaptor power supply when you run the Phlash utility. If the battery pack does not contain enough power to finish BIOS flash, you may not boot the system because the BIOS is not completely loaded.

Follow the steps below to run the Phlash.

1. Prepare a bootable diskette.
2. Copy the Phlash utilities to the bootable diskette.
3. Then boot the system from the bootable diskette. The Phlash utility has auto-execution function.

System Diagnostic Diskette

This diagnostic diskette is for the Acer Aspire 1450 series notebook machine. However, system diagnostic utility is not ready as service CD released. Acer HQ CSD will upload the utility to CSD website as soon as it is ready.

Machine Disassembly and Replacement

This chapter contains step-by-step procedures on how to disassemble the notebook computer for maintenance and troubleshooting.

To disassemble the computer, you need the following tools:

- Wrist grounding strap and conductive mat for preventing electrostatic discharge
- Small Philips screw driver
- Philips screw driver
- Flat head screwdriver
- Plastic flat head screw driver
- Hex screw driver
- Tweezers

NOTE: The screws for the different components vary in size. During the disassembly process, group the screws with the corresponding components to avoid mismatch when putting back the components. When you remove the stripe cover, please be careful not to scrape the cover.

General Information

Before You Begin

Before proceeding with the disassembly procedure, make sure that you do the following:

1. Turn off the power to the system and all peripherals.
2. Unplug the AC adapter and all power and signal cables from the system.
3. Remove the battery pack.

NOTE: Ferrari 3000 series product uses mylar or tape to fasten the FFC/FPC/connectors/cable, you may need to tear the tape or mylar before you disconnect different FFC/FPC/connectors.

Disassembly Procedure Flowchart

The flowchart on the succeeding page gives you a graphic representation on the entire disassembly sequence and instructs you on the components that need to be removed during servicing. For example, if you want to remove the system board, you must first remove the keyboard, then disassemble the inside assembly frame in that order.

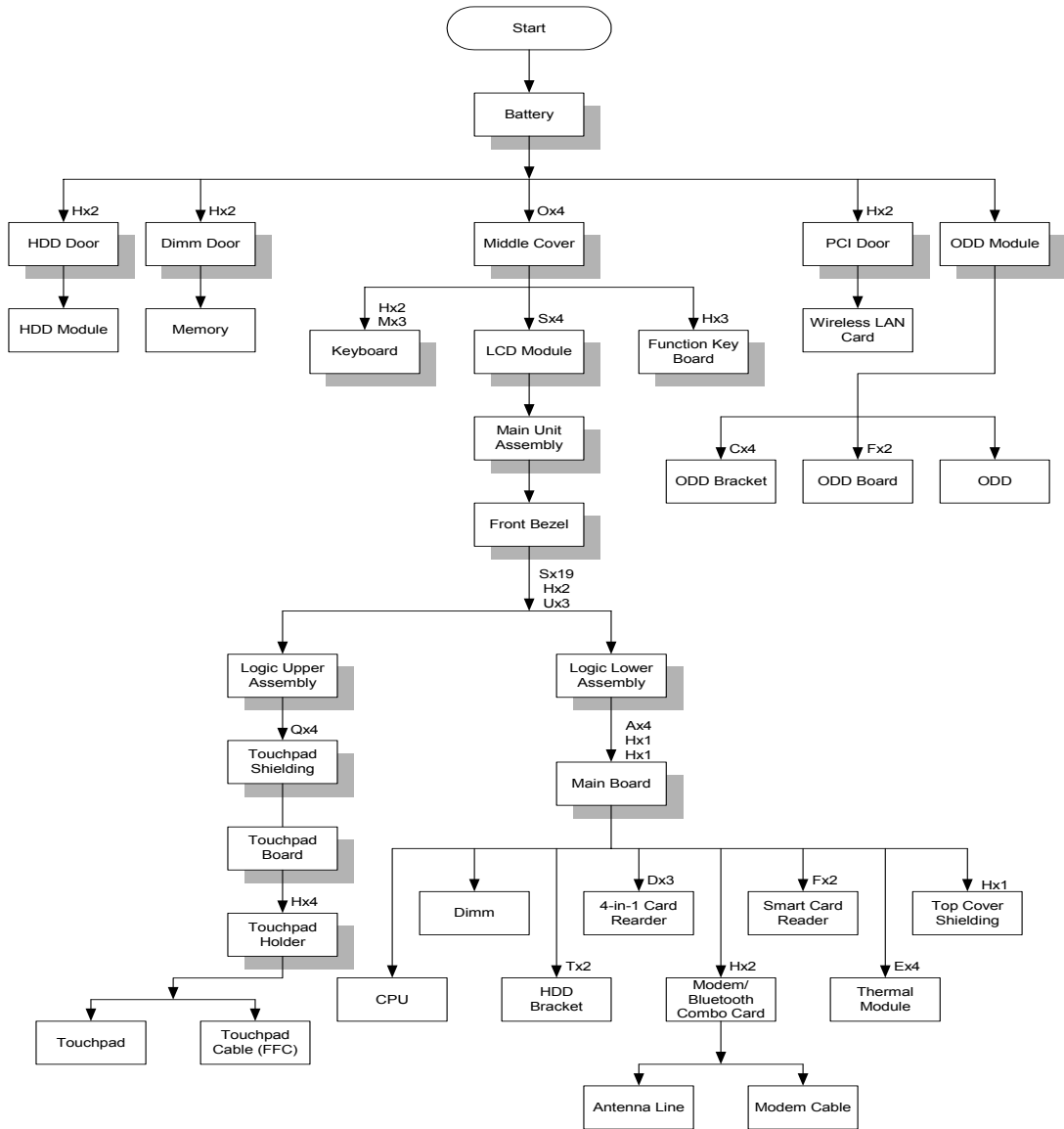

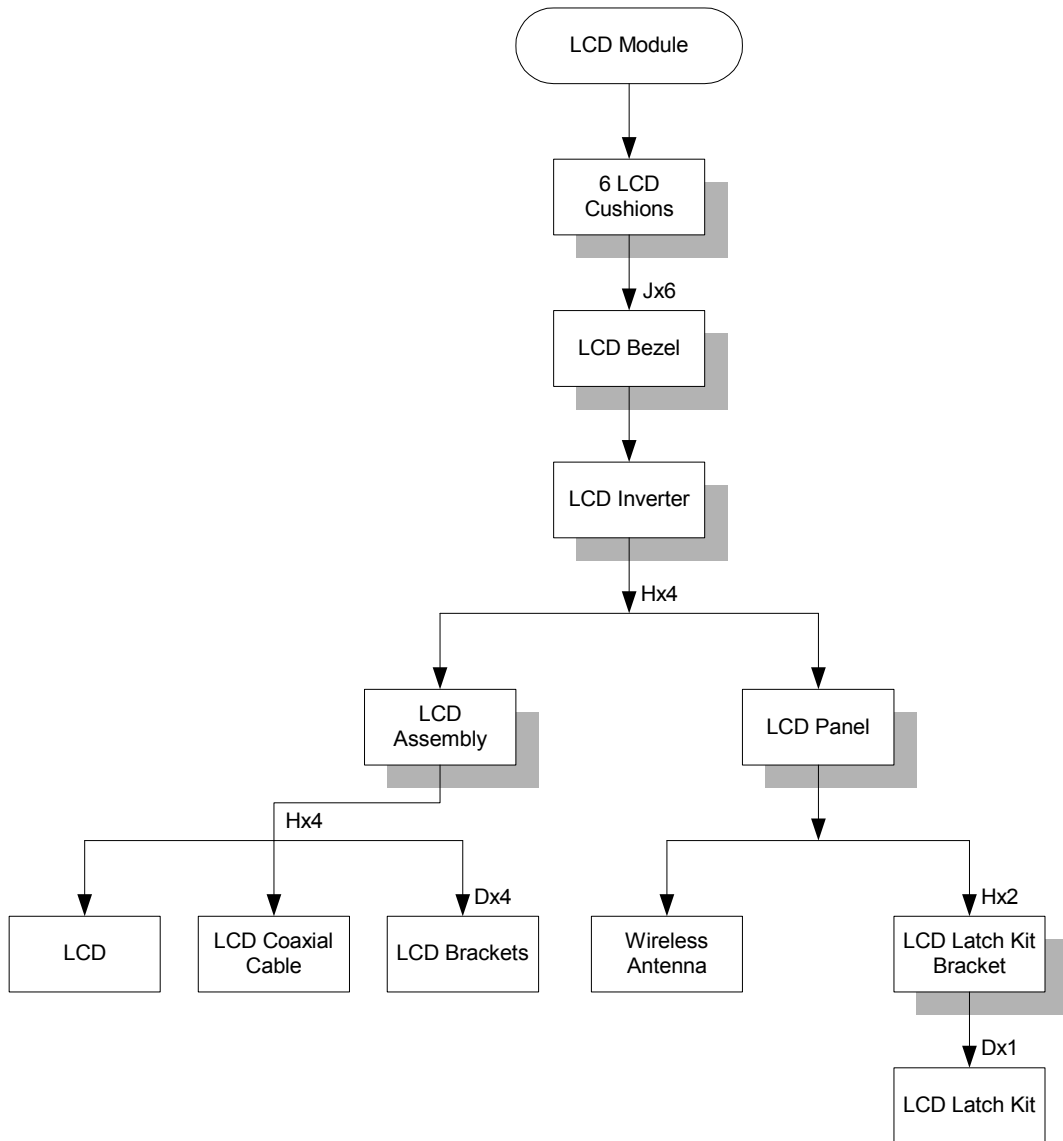

Screw List

Item	Description
A	NUT-I/O
B	SCREW M1.6X4.0-I-NI-NYLOK
C	SCREW M2.0X2.5-I-NI-NYLOK
D	SCREW M2.0X3.0-I-NI-NYLOK
E	SCREW M2.0X3.5-I-NI-NYLOK
F	SCREW M2.0X5-I-NI-NYLOK
G	SCREW M2.5X3-I-NI-NYLOK
H	SCREW M2.5X4.0-B-NI-NYLOK
I	SCREW M2.5X4-I-NYLOK
J	SCREW M2.5X5.0-I-NI-NYLOK
K	SCREW M2.5X5.5-P-NI-NYLOK

Item	Description
L	SCREW M2.5X0.45+7I-NYLOK
M	SCREW M1.7X3.5-I-BZN
N	SCREW M2X3-I-BNI-NYLOK
O	SCREW M2.0X5.0-I-BNI-NYLOK
P	SCREW M2.0X6.0-I-NI-NYLOK
Q	SCREW M2.5X2-I-NI-NYLOK
R	SCREW M2.5X4-I-BNI
S	SCREW M2.5X7
T	SCREW M3.0X3.5
U	SCREW M2.5X5 (BLACK)

Removing the Battery Pack

1. Release the battery lock.
2. Slide the battery latch then remove the battery.



Removing the Optical Module/HDD Module/Wireless Lan Card and LCD module

Removing the Optical Module

1. Slide the optical disk drive latch.
2. Remove the ODD module.



Removing the HDD Module

1. Remove the two screws holding the HDD cover.
2. Remove the HDD cover.
3. Remove the HDD module.



Removing the Wireless LAN Card

1. Remove the screw that secures the PCI door then remove the PCI door.
2. Disconnect the right and the left wireless antenna.
3. Pop out the wireless LAN card then remove it.



Removing the LCD Module

1. Remove the four screws that secures the middle cover; two one each side.
2. Detach middle cover with the assistance of a plastic flat head screw driver.
3. Disconnect the LCD cable then take out the cable from the upper case.



4. Disconnect the left wireless LAN antenna line. Then take out the antenna from the upper case with a tweezers.
5. Unscrew the four screws holding the LCD hinges; two on each side.
6. Then remove the entire LCD module.

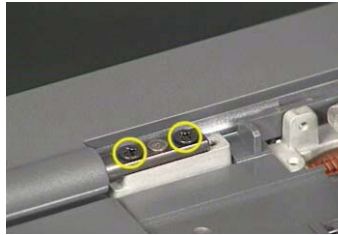

Disassembling the Main Unit

Remove the function key board and the keyboard

1. Take the wireless antenna out of the hook on the function key board.
2. Disconnect function key board connector
3. Unscrew the three screws holding the function key board.



4. Remove the three screws that secure the keyboard.
5. Turn over the unit and remove the two screws as the picture shows.
6. Turn over the keyboard. Disconnect the keyboard FFC then remove the keyboard.



Separate the main unit into the logic upper and the logic lower assembly

1. Remove the three screws on the rear panel.
2. Unscrew the 19 screws on the bottom panel.
3. Detach the front bezel from the main unit.

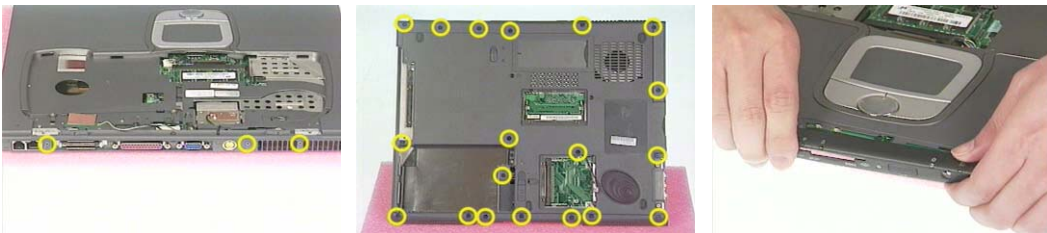

4. Remove the two screws. Then take the right and the left antenna off the main unit.
5. Disconnect the touchpad cable.
6. Pull out the right and the left wireless LAN antenna, then detach the logic upper assembly from the logic lower assembly.



Disassembling the logic upper assembly

1. Take out the touchpad cable from the small hook on touchpad holder.
2. Remove the four screws holding the touchpad shielding and the touchpad board.

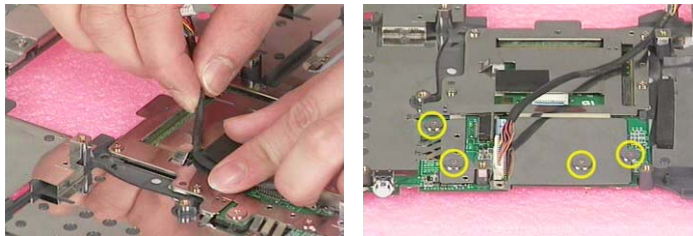

3. Disconnect the touchpad FFC from the touchpad board.
4. Remove the touchpad board.
5. Remove the wireless and bluetooth button off the touchpad board.



6. Remove the four screws that fasten the touchpad holder.
7. Remove the touchpad off the logic upper assembly.
8. Disconnect touchpad FFC.



Disassembling the logic lower assembly

1. In order to take out the main board from the upper case, first remove the four screws that fasten the top cover shielding.
2. Remove the three screws holding the 4-in-1 card reader, then remove it.

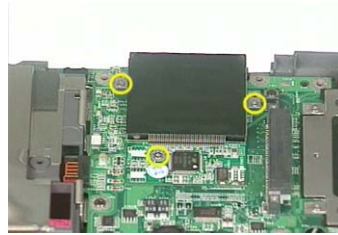
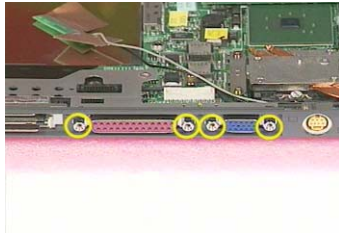

3. Unscrew the four screws that secure the thermal module.
4. Disconnect the fan connector then remove the thermal module.

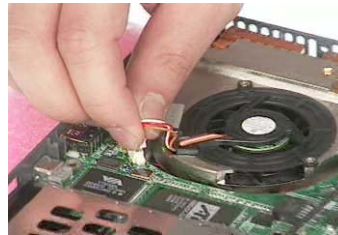

5. Remove one screw that secures the main board as picture shows.
6. Remove another screw that fastens the main board.
7. Take out the bluetooth antenna.

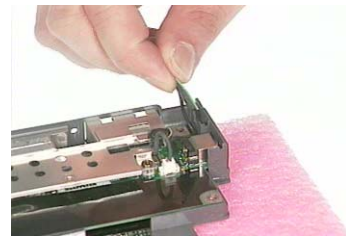
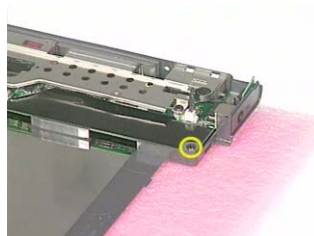
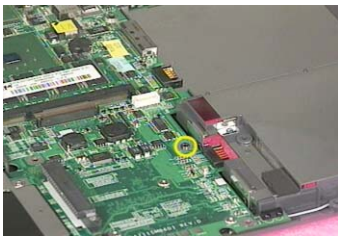

8. Disconnect the speaker set cable.
9. To remove the main board from the lower case assembly, first press the PCMCIA card button.
10. Then take the main board off the lower case assembly.



11. Unscrew the two screws that fasten the HDD bracket.
12. Remove one screw holding the top cover shielding.

13. Disconnect the microphone cable. Then remove the top cover shielding.

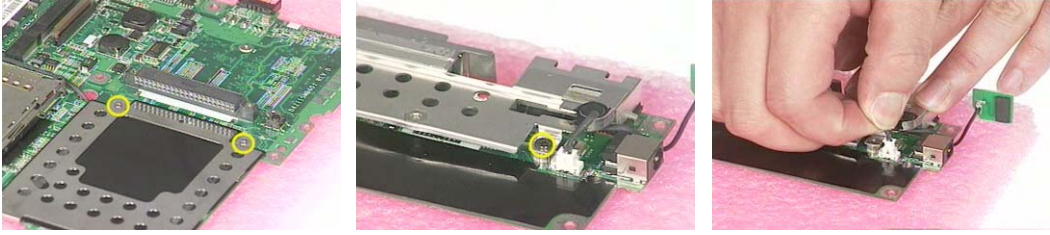

14. Turn the CPU lock counter clock-wise with a flat head screw driver. Then remove the CPU.
15. Pop out the memory then remove it.
16. Unscrew the two screws that secure the modem/bluetooth combo card. Remove the modem/bluetooth combo card then disconnect the connector.

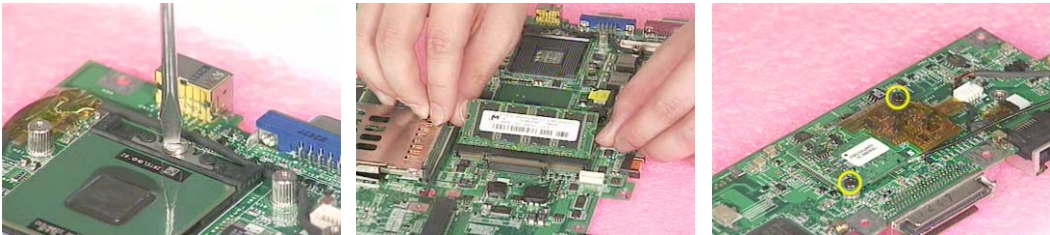

17. Disconnect the bluetooth antenna and the modem cable.
18. Disconnect the smart card reader FPC.
19. Unscrew the two screws holding the smart card reader then remove it.



Disassembling the LCD Module

1. Remove the six screw pad and the six screws.
2. Detach the LCD bezel carefully.
3. Disconnect LCD inverter.

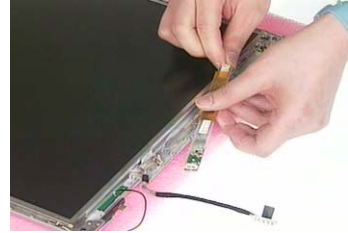

4. Remove the two screws holding the LCD to LCD panel.
5. Then remove the LCD.
6. Remove the four screws that fasten the right and the left LCD brackets. Then remove the right and the left LCD brackets.

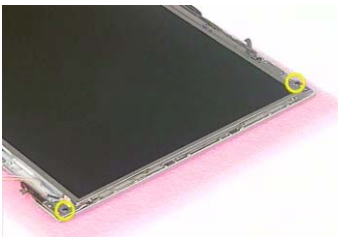

7. Tear off the electric conductive tape that fastens the LCD coaxial cable.
8. Tear off another electric conductive tape that fastens the LCD coaxial cable.
9. Disconnect the LCD coaxial cable.



10. Detach the wireless antenna from the LCD panel.
11. Remove the two screws holding the LCD latch kit.
12. Remove the LCD latch kit bracket.

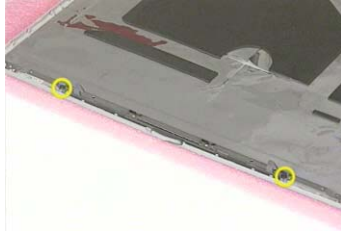

13. Unhook the spring.
14. Remove the screw that fastens the LCD latch kit.
15. Then remove the LCD latch kit.



Disassembling the External Modules

Disassembling the HDD Module

1. Remove the four screws holding the HDD bracket; two on each side.
2. Take out the HDD from the HDD bracket.

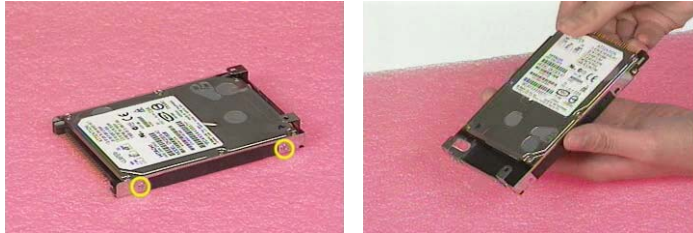

Disassembling the Optical Drive Module

1. Remove the two screws holding the ODD bracket.
2. Remove another screw as the picture shows.
3. Then remove the last two screws on the back side of the ODD module.

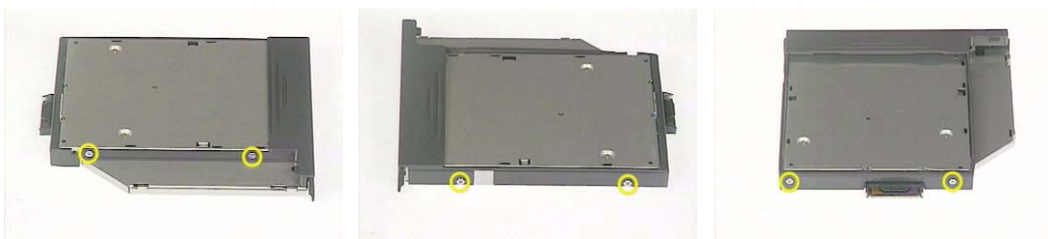

4. Slide the ODD from the ODD bracket.
5. Then remove the optical bracket.

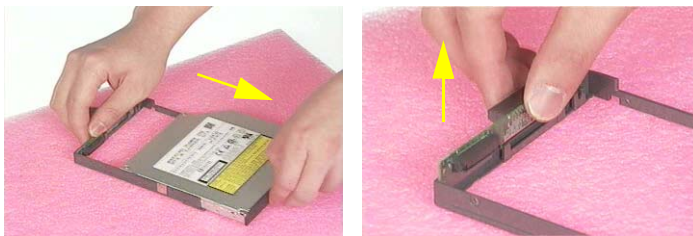

6. In order to open the ODD, use an uncurved pin to press the emergency eject hole.
7. Remove the three screws that fasten the ODD door.
8. Then detach the ODD door.



Troubleshooting

Use the following procedure as a guide for computer problems.

NOTE: The diagnostic tests are intended to test this model. Non-Acer products, prototype cards, or modified options can give false errors and invalid system responses.

1. Duplicate symptom and obtain the failing symptoms in as much detail as possible.
2. Distinguish symptom. Verify the symptoms by attempting to re-create the failure by running the diagnostic test or by repeating the same operation.
3. Disassemble and assemble the unit without any power sources.
4. If any problem occurs, you can perform visual inspection before you follow this chapter's instructions. You can check the following:
 - power cords are properly connected and secured;
 - there are no obvious shorts or opens;
 - there are no obviously burned or heated components;
 - all components appear normal.
5. Use the following table with the verified symptom to determine which page to go to.

Symptoms (Verified)	Go To
Power failure. (The power indicator does not go on or stay on.)	"Power System Check" on page 63.
POST does not complete. No beep or error codes are indicated.	"Power-On Self-Test (POST) Error Message" on page 65 "Undetermined Problems" on page 77
POST detects an error and displayed messages on screen.	"Error Message List" on page 66
The diagnostic test detected an error and displayed a FRU code.	"System Diagnostic Diskette" on page 44
Other symptoms (i.e. LCD display problems or others).	"Power-On Self-Test (POST) Error Message" on page 65
Symptoms cannot be re-created (intermittent problems).	Use the customer-reported symptoms and go to "Power-On Self-Test (POST) Error Message" on page 65 "Intermittent Problems" on page 76 "Undetermined Problems" on page 77

System Check Procedures

External Diskette Drive Check

Do the following to isolate the problem to a controller, driver, or diskette. A write-enabled, diagnostic diskette is required.

NOTE: Make sure that the diskette does not have more than one label attached to it. Multiple labels can cause damage to the drive or cause the drive to fail.

Do the following to select the test device. See “System Diagnostic Diskette” on page 44 for details.

1. Boot from the diagnostics diskette and start the diagnostics program (see “System Diagnostic Diskette” on page 44).
2. See if FDD Test is passed as the program runs to FDD Test.
3. Follow the instructions in the message window.

If an error occurs with the internal diskette drive, reconnect the diskette connector on the system board.

If the error still remains:

1. Reconnect the external diskette drive/DVD-ROM module.
2. Replace the external diskette drive/CD-ROM module.
3. Replace the main board.

External CD-ROM Drive Check

Do the following to isolate the problem to a controller, drive, or CD-ROM. Make sure that the CD-ROM does not have any label attached to it. The label can cause damage to the drive or can cause the drive to fail.

Do the following to select the test device:

1. Boot from the diagnostics diskette and start the diagnostics program (refer to “System Diagnostic Diskette” on page 44).
2. See if CD-ROM Test is passed when the program runs to CD-ROM Test.
3. Follow the instructions in the message window.

If an error occurs, reconnect the connector on the System board. If the error still remains:

1. Reconnect the external diskette drive/CD-ROM module.
2. Replace the external diskette drive/CD-ROM module.
3. Replace the main board.

Keyboard or Auxiliary Input Device Check

Remove the external keyboard if the internal keyboard is to be tested.

If the internal keyboard does not work or an unexpected character appears, make sure that the flexible cable extending from the keyboard is correctly seated in the connector on the system board.

If the keyboard cable connection is correct, run the Keyboard Test. See “System Diagnostic Diskette” on page 44 for details.

If the tests detect a keyboard problem, do the following one at a time to correct the problem. Do not replace a non-defective FRU:

1. Reconnect the keyboard cables.
2. Replace the keyboard.
3. Replace the main board.

The following auxiliary input devices are supported by this computer:

- Numeric keypad

-
- External keyboard

If any of these devices do not work, reconnect the cable connector and repeat the failing operation.

Memory check

Memory errors might stop system operations, show error messages on the screen, or hang the system.

1. Boot from the diagnostics diskette and start the doagmpstotics program (please refer to main board).
2. Go to the diagnostic memory in the test items.
3. Press F2 in the test items.
4. Follow the instructions in the message window.

NOTE: Make sure that the DIMM is fully installed into the connector. A loose connection can cause an error.

Power System Check

To verify the symptom of the problem, power on the computer using each of the following power sources:

1. Remove the battery pack.
2. Connect the power adapter and check that power is supplied.
3. Disconnect the power adapter and install the charged battery pack; then check that power is supplied by the battery pack.

If you suspect a power problem, see the appropriate power supply check in the following list:

- "Check the Battery Pack" on page 64

Check the Battery Pack

To check the battery pack, do the following:

From Software:

1. Check out the Power Management in control Panel
2. In Power Meter, confirm that if the parameters shown in the screen for Current Power Source and Total Battery Power Remaining are correct.
3. Repeat the steps 1 and 2, for both battery and adapter.
4. This helps you identify first the problem is on recharging or discharging.

From Hardware:

1. Power off the computer.
2. Remove the battery pack and measure the voltage between battery terminals 1(+) and 6(ground). See the following figure
3. If the voltage is still less than 7.5 Vdc after recharging, replace the battery.

To check the battery charge operation, use a discharged battery pack or a battery pack that has less than 50% of the total power remaining when installed in the computer.

If the battery status indicator does not light up, remove the battery pack and let it return to room temperature. Re-install the battery pack.

If the charge indicator still does not light up, replace the battery pack. If the charge indicator still does not light up, replace the DC/DC charger board.

Touchpad check

If the touchpad doesn't work, do the following actions one at a time to correct the problem. Do not replace a non-defective FRU:

1. After rebooting, run Tracking Pad PS2 Mode Driver. For example, run Syn touch driver.
2. Run utility with the PS/2 mouse function and check if the mouse is working.
3. If the the PS/2 mouse does not work, then check if the main board to switch board FPC is connected O.K.
4. If the main board to switch board FPC is connected well, then check if the FCC on touch pad PCB connects properly.
5. If the FFC on touch pad PCB connects properly, then check if LS851 JP1 Pin6=5V are pulese. If yes, then replace switch board. If no, then go to next step.
6. Replace touch pad PCB.
7. If the touch pad still does not work, then replace FPC on Track Pad PCB.

After you use the touchpad, the pointer drifts on the screen for a short time. This self-acting pointer movement can occur when a slight, steady pressure is applied to the touchpad pointer. This symptom is not a hardware problem. No service actions are necessary if the pointer movement stops in a short period of time.

Power-On Self-Test (POST) Error Message

The POST error message index lists the error message and their possible causes. The most likely cause is listed first.

NOTE: Perform the FRU replacement or actions in the sequence shown in FRU/Action column, if the FRU replacement does not solve the problem, put the original part back in the computer. Do not replace a non-defective FRU.

This index can also help you determine the next possible FRU to be replaced when servicing a computer.

If the symptom is not listed, see “Undetermined Problems” on page 77.

The following lists the error messages that the BIOS displays on the screen and the error symptoms classified by function.

NOTE: Most of the error messages occur during POST. Some of them display information about a hardware device, e.g., the amount of memory installed. Others may indicate a problem with a device, such as the way it has been configured.

NOTE: If the system fails after you make changes in the BIOS Setup Utility menus, reset the computer, enter Setup and install Setup defaults or correct the error.

Index of Error Messages

Error Message List

Error Messages	FRU/Action in Sequence
Struck Key	See “Keyboard or Auxiliary Input Device Check” on page 62
System CMOS checksum bad - Default configuration used	RTC battery Run BIOS Setup Utility to reconfigure system, then reboot system.
Real time clock error	RTC battery Run BIOS Setup Utility to reconfigure system time, then reboot system. Main board
Previous boot incomplete - Default configuration used	“Load Default Settings” in BIOS Setup Utility. RTC batter Main board.
Invalid System Configuration Data	“Load Default Settings” in BIOS Setup Utility. Main board.
Operating system not found	Enter Setup and see if fixed disk and drive A are properly identified. Dikette drive Hard disk drive Main board.

Error Message List

No beep Error Messages	FRU/Action in Sequence
Power-on indicator turns off and LCD is blank.	Power source (battery pack and power adapter.) See "Power System Check" on page 63 Ensure every connector is connected tightly and correctly. Reconnect the DIMM. Main board.
Power-on indicator turns on and LCD is blank.	Power source (battery pack and power adapter.) See "Power System Check" on page 63 Reconnect the LCD connector Hard disk drive LCD cable LCD inverter LCD Main board
Power-on indicator turns on and LCD is blank. But you can see POST on an external CRT.	Reconnect the LCD connectors. LCD cable LCD inverter LCD Main board
Power-on indicator turns on and a blinking cursor shown on LCD during POST.	Ensure every connector is connected tightly and correctly. Main board

POST Codes

Code	Beeps	POST Routine Description
02h		Verify Real Mode
03h		Disable Non-Maskable Interrupt (NMI)
04h		Get CPU type
06h		Initialize system hardware
08h		Initialize chipset with initial POST values
09h		Set IN POST flag
0Ah		Initialize CPU registers
0Bh		Enable CPU cache
0Ch		Initialize caches to initial POST values
0Eh		Initialize I/O component
0Fh		Initialize the local bus IDE
10h		Initialize Power Management
11h		Load alternate registers with initial POST values
12h		Restore CPU control word during warm boot
13h		Initialize PCI Bus Mastering devices
14h		Initialize keyboard controller
16h	1-2-2-3	BIOS ROM checksum
17h		Initialize cache before memory autosize
18h		8254 timer initialization
1Ah		8237 DMA controller initialization
1Ch		Reset Programmable Interrupt Controller
20h	1-3-1-1	Test DRAM refresh
22h	1-3-1-3	Test 8742 Keyboard Controller
24h		Set ES segment register to 4 GB
26h		Enable A20 line
28h		Autosize DRAM
29h		Initialize POST Memory Manager
2Ah		Clear 215 KB base RAM
2Ch	1-3-4-1	RAM failure on address line xxxx
2Eh	1-3-4-3	RAM failure on data bits xxxx of low byte of memory bus
2Fh		Enable cache before system BIOS shadow
30h	1-4-1-1	RAM failure on data bits xxxx of high byte of memory bus
32h		Test CPU bus-clock frequency
33h		Initialize Phoenix Dispatch Manager
36h		Warm start shut down
38h		Shadow system BIOS ROM
3Ah		Autosize cache
3Ch		Advanced configuration of chipset registers
3Dh		Load alternate registers with CMOS values
42h		Initialize interrupt vectors
45h		POST device initialization
46h	2-1-2-3	Check ROM copyright notice

Code	Beeps	POST Routine Description
48h		Check video configuration against CMOS
49h		Initialize PCI bus and devices
4Ah		Initialize all video adapters in system
4Bh		QuietBoot start (optional)
4Ch		Shadow video BIOS ROM
4Eh		Display BIOS copyright notice
50h		Display CPU type and speed
51h		Initialize EISA board
52h		Test keyboard
54h		Set key click if enabled
58h	2-2-3-1	Test for unexpected interrupts
59h		Initialize POST display service
5Ah		Display prompt "Press F2 to enter SETUP"
5Bh		Disable CPU cache
5Ch		Test RAM between 512 and 640 KB
60h		Test extended memory
62h		Test extended memory address lines
64h		Jump to User Patch1
66h		Configure advanced cache registers
67h		Initialize Multi Processor APIC
68h		Enable external and CPU caches
69h		Setup System Management Mode (SMM) area
6Ah		Display external L2 cache size
6Bh		Load custom defaults (optional)
6Ch		Display shadow-area message
6Eh		Display possible high address for UMB recovery
70h		Display error messages
72h		Check for configuration errors
76h		Check for keyboard errors
7Ch		Set up hardware interrupt vectors
7Eh		Initialize coprocessor if present
80h		Disable onboard Super I/O ports and IRQs
81h		Late POST device initialization
82h		Detect and install external RS232 ports
83h		Configure non-MCD IDE controllers
84h		Detect and install external parallel ports
85h		Initialize PC-compatible PnP ISA devices
86h		Re-initialize onboard I/O ports
87h		Configure Motherboard Configurable Devices (optional)
88h		Initialize BIOS Area
89h		Enable Non-Maskable Interrupts (NMIs)
8Ah		Initialize Extended BIOS Data Area
8Bh		Test and initialize PS/2 mouse
8Ch		Initialize floppy controller

Code	Beeps	POST Routine Description
8Fh		Determine number of ATA drives (optional)
90h		Initialize hard-disk controllers
91h		Initialize local-bus hard-disk controllers
92h		Jump to UserPatch2
93h		Build MPTABLE for multi-processor boards
95h		Install CD ROM for boot
96h		Clear huge ES segment register
97h		Fixup Multi Processor table
98h	1-2	Search for option ROMs. One long, two short beeps on checksum failure.
99h		Check for SMART drive (optional)
9Ah		Shadow option ROMs
9Ch		Set up Power Management
9Dh		Initialize security engine (optional)
9Eh		Enable hardware interrupts
9Fh		Determine number of ATA and SCSI drives
A0h		Set time of day
A2h		Check key lock
A4h		Initialize Typematic rate
A8h		Erase F2 prompt
AAh		Scan for F2 key stroke
ACh		Enter SETUP
A Eh		Clear Boot flag
B0h		Check for errors
B2h		POST done- prepare to boot operating system
B4h	1	One short beep before boot
B5h		Terminate QuietBoot (optional)
B6h		Check password (optional)
B9h		Prepare Boot
BAh		Initialize DMI parameters
BBh		Initialize PnP Option ROMs
BCh		Clear parity checkers
BDh		Display MultiBoot menu
BEh		Clear screen (optional)
BFh		Check virus and backup reminders
C0h		Try to boot with INT 19
C1h		Initialize POST Error Manager (PEM)
C2h		Initialize error logging
C3h		Initialize error display function
C4h		Initialize system error handler
C5h		PnPnd dual CMOS (optional)
C6h		Initialize notebook docking (optional)
C7h		Initialize notebook docking late
C8h		Force check (optional)
C9h		Extended checksum (optional)
D2h		Unknown interrupt

Code	Beeps	For Boot Block in Flash ROM
E0h		Initialize the chipset
E1h		Initialize the bridge
E2h		Initialize the CPU
E3h		Initialize the system timer
E4h		Initialize system I/O
E5h		Check force recovery boot
E6h		Checksum BIOS ROM
E7h		Go to BIOS
E8h		Set Huge Segment
E9h		Initialize Multi Processor
EAh		Initialize OEM special code
EBh		Initialize PIC and DMA
ECh		Initialize Memory type
EDh		Initialize Memory size
EEh		Shadow Boot Block
EFh		System memory test
F0h		Initialize interrupt vectors
F1h		Initialize Run Time Clock
F2h		Initialize video
F3h		Initialize System Management Mode
F4h	1	Output one beep before boot
F5h		Boot to Mini DOS
F6h		Clear Huge Segment
F7h		Boot to Full DOS

Index of Symptom-to-FRU Error Message

LCD-Related Symptoms

Symptom / Error	Action in Sequence
LCD backlight doesn't work	First, plug a monitor to CRT port. Next, enter BIOS utility to running "Load Default Settings" then reboot the system. Reconnect the LCD connectors. Keyboard (if the brightness function key doesn't work). LCD cable LCD inverter LCD Main board
LCD is too dark LCD brightness cannot be adjusted	Enter BIOS Utility to execute "Load Setup Default Settings", then reboot system. Reconnect the LCD connectors. Keyboard (if the brightness function key doesn't work). LCD cable LCD inverter LCD Main board
Unreadable LCD screen Missing pels in characters Abnormal screen Wrong color displayed LCD has extra horizontal or vertical lines displayed.	Reconnect the LCD cable LCD cable LCD Main board

Indicator-Related Symptoms

Symptom / Error	Action in Sequence
Indicator incorrectly remains off or on, but system runs correctly	Main board
HDD/CD-ROM active indicators cannot work	HDD/CD-ROM drive Device driver Main board

Power-Related Symptoms

Symptom / Error	Action in Sequence
Power shuts down during operation	Power source (battery pack and power adapter). See "Power System Check" on page 63. Battery pack AC adapter See if the thermal module is overheat (Heat sink or fan). Main board
The system cannot power-on.	Power source (battery pack and power adapter). See "Power System Check" on page 63. Battery pack Power adapter CPU Main board
The system cannot power-off.	In Windows XP operating system, hold and press the power switch for more than 4 seconds. If the system can power off, then the main board is OK. Verify OS in the HDD. Main board

Power-Related Symptoms

Symptom / Error	Action in Sequence
Battery can't be charged or discharged	See "Check the Battery Pack" on page 64. Battery pack Main board
System hang during POST	ODD/HDD/FDD/RAM module Main board

PCMCIA-Related Symptoms

Symptom / Error	Action in Sequence
System cannot detect the PC Card (PCMCIA)	PCMCIA slot assembly Main board
PCMCIA slot pin is damaged.	PCMCIA slot assembly
PC Card cannot be inserted or ejected	Check if the PCMCIA slot is blocked Main board

Memory-Related Symptoms

Symptom / Error	Action in Sequence
Memory count (size) appears different from actual size.	Enter BIOS Setup Utility to execute "Load Default Settings" then reboot system. RAM module Main board Check BIOS revision
System can power on, but you hear two long beeps: "B--, B--" and the LCD is blank.	Reinsert DIMM DIMM Main board

Speaker-Related Symptoms

Symptom / Error	Action in Sequence
In Windows, multimedia programs, no sound comes from the computer.	OS volume control Audio driver Speaker Main board
Internal speakers make noise or emit no sound.	Speaker Main board
Microphone cannot work	Audio driver Volume control in Windows XP Main board

Power Management-Related Symptoms

Symptom / Error	Action in Sequence
The system will not enter hibernation mode	Power option in Windows XP Hard disk drive Main board
The system doesn't enter standby mode after closing the lid of the portable computer.	Driver of Power Option Properties Lid close switch in upper case Main board

Power Management-Related Symptoms

Symptom / Error	Action in Sequence
The system doesn't resume from hibernation/standby mode.	Connect AC adapter then check if the system resumes from Standby/Hibernation mode. Check if the battery is low. Hard disk drive Main board
The system doesn't resume from standby mode after opening the lid of the portable computer.	LCD cover switch Main board
Battery fuel gauge in Windows doesn't go higher than 90%.	Refresh battery (continue use battery until power off, then charge battery). Battery pack Main board
System hangs intermittently.	Reconnect hard disk/CD-ROM drives. Main board

Peripheral-Related Symptoms

Symptom / Error	Action in Sequence
System configuration does not match the installed devices.	Enter BIOS Setup Utility to execute "Load Setup defaults", then reboot system. Reconnect hard disk/CD-ROM drives/FDD or other peripherals. Main board
External display does not work correctly.	Press Fn+F5, LCD/CRT/Both display switching Keyboard Main board
USB does not work correctly	See "System Diagnostic Diskette" on page 44 Main board
Print problems.	Enter BIOS Setup Utility to execute "Load Default Settings" then reboot the system. Run printer self-test. Printer driver Printer cable Printer Main board
Parallel port device problems	Enter BIOS Setup Utility to execute "Load Default Settings" then reboot the system. Device driver Device cable Device Main board

Keyboard/Touchpad-Related Symptoms

Symptom / Error	Action in Sequence
Keyboard (one or more keys) does not work.	Reconnect the keyboard cable. Keyboard Main board
Touchpad does not work.	Reconnect touchpad cable. Touchpad board Main board

Modem/LAN-Related Symptoms

Symptom / Error	Action in Sequence
Internal modem does not work correctly.	See "System Diagnostic Diskette" on page 44. Phone cable Driver Reconnect the Internal modem cable to the main board tightly. Main board
Internal LAN does not work correctly	Lan cable Driver Main board

NOTE: If you cannot find a symptom or an error in this list and the problem remains, see "Undetermined Problems" on page 77.

Intermittent Problems

Intermittent system hang problems can be caused by a variety of reasons that have nothing to do with a hardware defect, such as: cosmic radiation, electrostatic discharge, or software errors. FRU replacement should be considered only when a recurring problem exists.

When analyzing an intermittent problem, do the following:

1. Run the diagnostic test for the system board in loop mode at least 10 times.
2. If no error is detected, do not replace any FRU.
3. If any error is detected, replace the FRU. Rerun the test to verify that there are no more errors.

Undetermined Problems

The diagnostic problems does not identify which adapter or device failed, which installed devices are incorrect, whether a short circuit is suspected, or whether the system is inoperative.

Follow these procedures to isolate the failing FRU (do not isolate non-defective FRU).

NOTE: Verify that all attached devices are supported by the computer.

NOTE: Verify that the power supply being used at the time of the failure is operating correctly. (See “Power System Check” on page 63):

1. Power-off the computer.
2. Visually check them for damage. If any problems are found, replace the FRU.
3. Remove or disconnect all of the following devices:
 - Non-Acer devices
 - Printer, mouse, and other external devices
 - Battery pack
 - Hard disk drive
 - DIMM
 - PC Cards
4. Power-on the computer.
5. Determine if the problem has changed.
6. If the problem does not recur, reconnect the removed devices one at a time until you find the failing FRU.
7. If the problem remains, replace the following FRU one at a time. Do not replace a non-defective FRU:
 - System board
 - LCD assembly

Jumper and Connector Locations

Top View

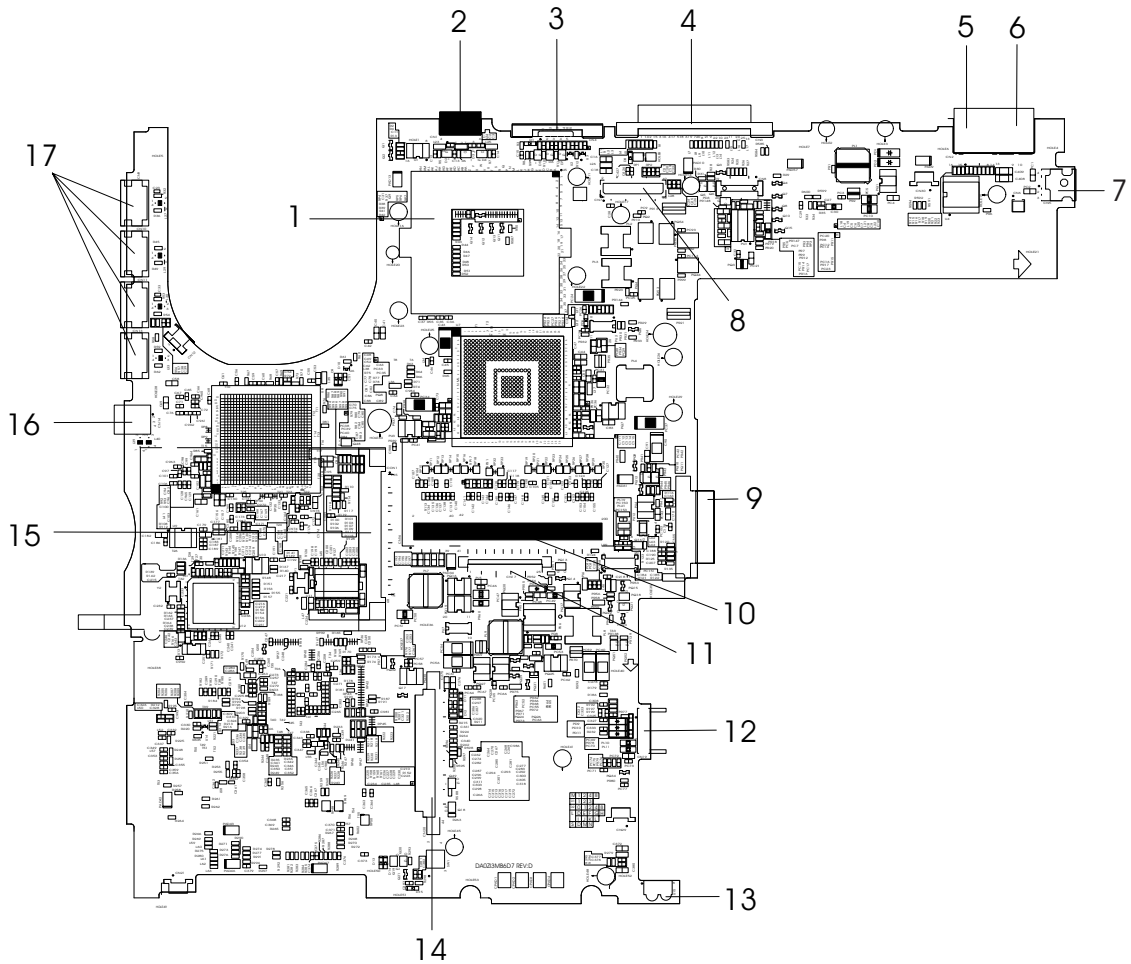

1	U5	CPU socket	10	CN16	DIMM socket
2	CN1	S-video port	11	CN17	Keyboard connector
3	CN4	CRT	12	CN19	Main battery connector
4	CN3	Docking	13	U15	IR
5	CN2	RJ45	14	CN20	HDD connector
6	CN2	RJ11	15	CON1	PCMCIA slot
7	CN5	Power jack	16	CN14	IEEE 1394 port
8	CN7	LCD connector	17	CN9-11 CN13	Four USB ports
9	CN15	Optical drive connector			

Bottom View

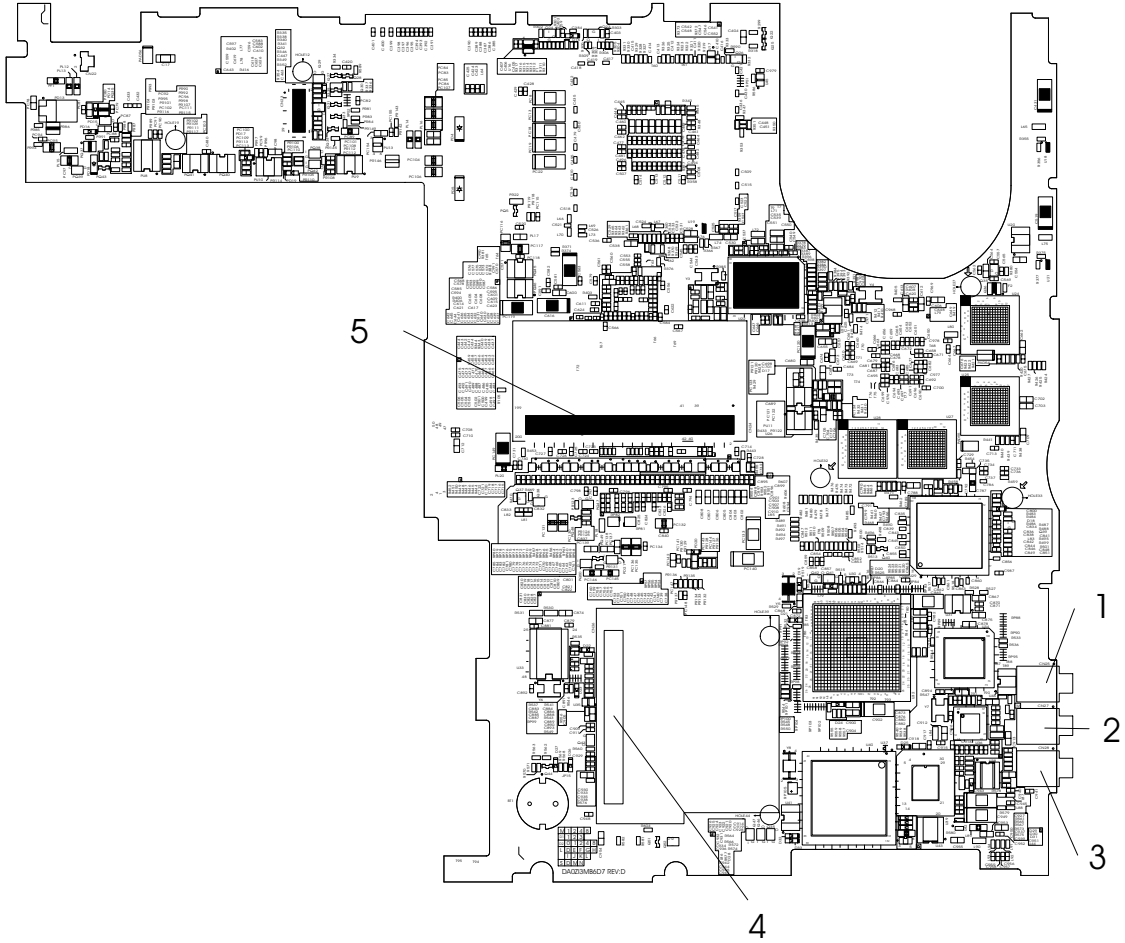

- 1 CN25 Line-in connector
- 2 CN27 Microphone-in connector
- 3 CN28 Line-out connector
- 4 CN26 Mini PCI connector
- 5 CN24 DIMM socket

FRU (Field Replaceable Unit) List

This chapter gives you the FRU (Field Replaceable Unit) listing in global configurations of Ferrari 3000 series products. Refer to this chapter whenever ordering for parts to repair or for RMA (Return Merchandise Authorization).





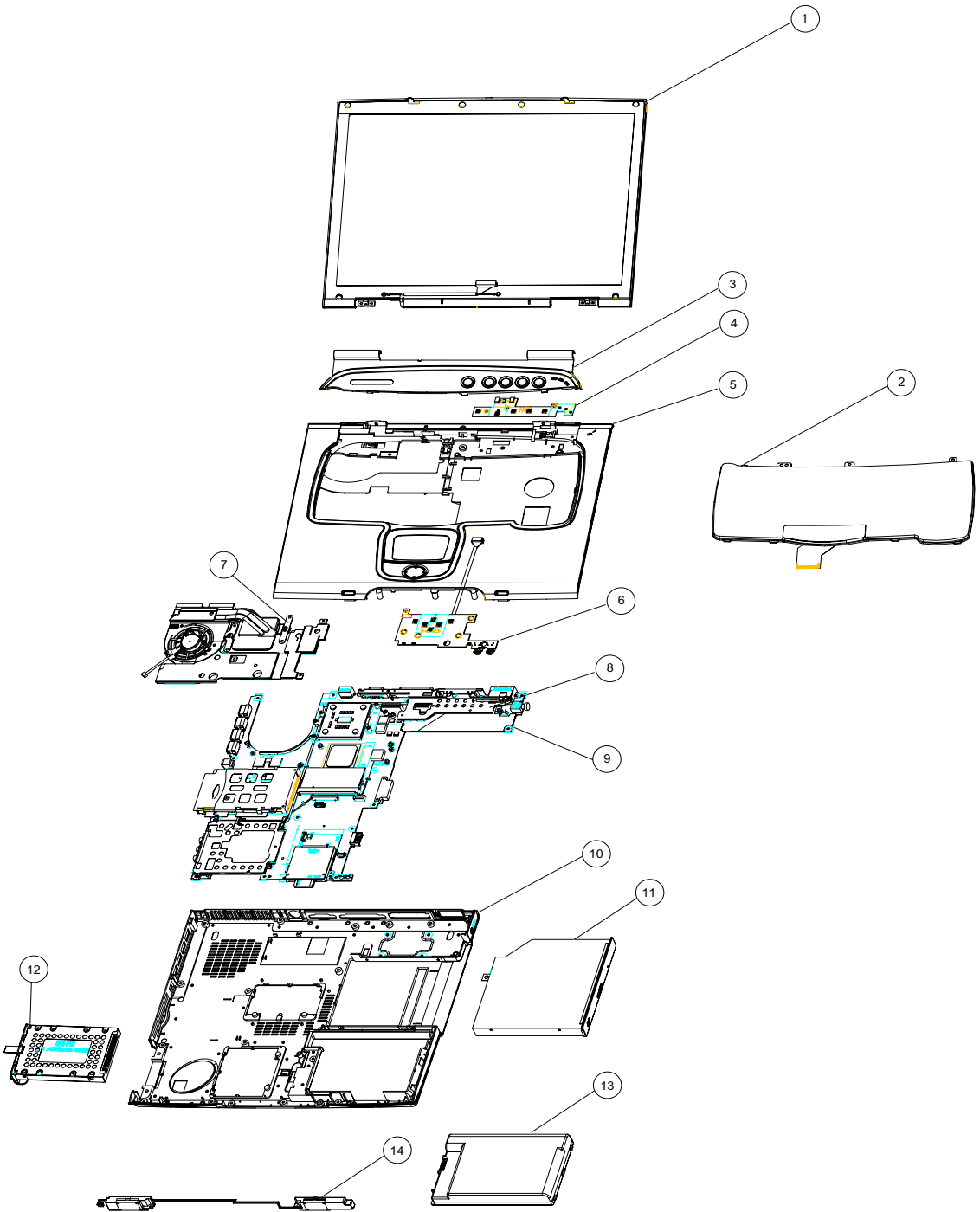

Please note that WHEN ORDERING FRU PARTS, you should check the most up-to-date information available on your regional web or channel. For whatever reasons a part number change is made, it will not be noted on the printed Service Guide. For ACER AUTHORIZED SERVICE PROVIDERS, your Acer office may have a DIFFERENT part number code from those given in the FRU list of this printed Service Guide. You MUST use the local FRU list provided by your regional Acer office to order FRU parts for repair and service of customer machines.

NOTE: To scrap or to return the defective parts, you should follow the local government ordinance or regulations on how to dispose it properly, or follow the rules set by your regional Acer office on how to return it.







NOTE: Exploded diagram is not ready as service CD released. We will update the service guide to CSD website, please download the exploded diagram from the website if you need the files

Exploded Diagram



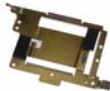





Picture	No.	Partname And Description	Part Number
Adapter			
	NS	ADAPTER LITE- ON PA-1900-05QA 3PIN W/ LED 90W	AP.A1003.001
		ADAPTER LSE 0202C1990 3PIN W/LED 90W	AP.A1007.001
Battery			
	13	BATTERY SANYO LI-ION 8CELL (4UR18650F-2-QC-ZG1, 4400mAH)	BT.FR103.001
		BATTERY SIMPLO LI-ION 8CELL (LI-ION BATTERY PACK ZG14S2P, 4400mAH)	BT.FR107.001
Boards			
	NS	MODEM CARD (Ambit T60M283.10)	54.T29V7.001
	NS	MODEM /BLUETOOTH COMBO BOARD AMBIT T60M665.00	54.T23V7.002
	NS	WIRELESS LAN BOARD (802.11g) WNC KM8-1	54.A13V7.001
	4	LAUNCH BOARD	55.T23V7.001
	NS	TOUCH PAD BOARD W/CABLE	55.T23V7.002
Cables			

Picture	No.	Partname And Description	Part Number
	NS	TOUCHPAD CABLE	50.T23V7.001
	NS	MODEM CABLE	50.T23V7.002
	NS	COVER SWITCH CABLE	50.T23V7.003
	NS	POWER CORD US (3 pin)	27.A03V7.001
	NS	POWER CORD EU (3 Pin)	27.T23V7.002
	NS	POWER CORD PRC (3 Pin)	27.T23V7.003
	NS	POWER CORD UK (3 PIN)	27.A03V7.004
	NS	POWER CORD ITALIAN (3 PIN)	27.A03V7.005
	NS	POWER CORD DANISH (3 PIN)	27.A03V7.006
	NS	POWER CORD AU (3 PIN)	27.A03V7.008
Case/Cover/Bracket Assembly			
	3	MIDDLE COVER W/ NAME PLATE	42.FR1V7.001
	NS	DIMM DOOR W/SCREW	42.FR1V7.002
	10	LOWER CASE W/O SPEAKER	60.FR1V7.001
	5	UPPER CASE W/TOUCHPAD HOLDER	60.FR1V7.002
	8	I/O BRACKET W/MICROPHONE	33.FR1V7.001

Picture	No.	Partname And Description	Part Number
	NS	FRONT BEZEL FOR 4 IN 1 MODEL	42.T23V7.003
	NS	FRONT BEZEL FOR NON-4 IN 1 MODEL	42.T23V7.103
	NS	TOUCH PAD SHIELDING FOR TOUCH PAD BOARD	33.T23V7.001
	NS	TOUCH PAD BRACKET FOR TOUCH PAD	33.T23V7.002
	NS	WIRELESS BOARD COVER	42.FR1V7.003
Communication Module			
	NS	BLUETOOTH ANTENNA	50.T23V7.004
	NS	WIRELESS LAN ANTENNA Y CABLE	50.A13V7.001
	NS	WIRELESS LAN ANTENNA	50.A13V7.002
CPU			
	NS	AMD Athlon XP Barton 2500+(1.8GHz) 40W Low-Voltage OPGA	KC.A2502.40W
HDD/ Hard Disk Drive			
	12	HDD 2.5" 30G HGST MORAGA IC25N030ATMR04-0 08K0910 2.5"	KH.03007.002
		HDD 2.5" 30G TOSHIBA NEPTUNE MK3021GAS	KH.33004.001

Picture	No.	Partname And Description	Part Number
		HDD 2.5" 30G FUJITSU V-40 MHT2030AT 4.2KRPM F/W:009A	KH.03006.002
		HDD 2.5" 40G HGST MORAGA IC25N040ATMR04-0 08K0633	KH.04007.004
		HDD 2.5" 40G TOSHIBA NEPTUNE MK4025GAS F/W:KA100A	KH.04004.002
		HDD 2.5" 40G FUJITSU V40+ MHT2040AT 4.2KRPM F/W:0021	KH.04006.003
		HDD 2.5" 60G HGST MORAGA IC25N060ATMR04-0 08K0634	KH.06007.002
		HDD 2.5" 60G TOSHIBA NEPTUNE MK6021GAS	KH.36004.001
		HDD 2.5" 60G FUJITSU V40+ MHT2060AT 4.2KRPM F/W:0021	KH.06006.003
	NS	HDD COVER	42.FR1V7.005
	NS	HDD CASE	33.FR1V7.002
Keyboard			
	2	KEYBOARD DARFON US INTERNATIONAL (99.N3482.41D, 84 keys)	KB.T2307.001
		KEYBOARD DARFON SPANISH (99.N3482.40S, 85 keys)	KB.T2307.003
		KEYBOARD DARFON BRAZILIAN PROTUGESE (99.N3482.406, 85 Keys)	KB.T2307.005
		KEYBOARD DARFON UK NSK-A640U 85KEYS	KB.T2507.002
		KEYBOARD DARFON GERMAN NSK-A640G 85KEYS	KB.T2507.003
		KEYBOARD DARFON ITALIAN NSK-A640E 85KEYS	KB.T2507.004
		KEYBOARD DARFON FRENCH NSK-A640F 85KEYS	KB.T2507.006
		KEYBOARD DARFON SWISS/G NSK-A6400 85KEYS	KB.T2507.007
		KEYBOARD DARFON PORTUGUESE NSK-06 85KEYS	KB.T2507.009
		KEYBOARD DARFON ARABIC NSK-A640A 84KEYS	KB.T2507.010
		KEYBOARD DARFON BELGIUM NSK-A641A 85KEYS	KB.T2507.012
		KEYBOARD DARFON SWEDEN NSK-A640W 85KEYS	KB.T2507.013
		KEYBOARD DARFON CZECH NSK-A640C 85KEYS	KB.T2507.014
		KEYBOARD DARFON HUNGAIAN NSK-A640Q 85KEYS	KB.T2507.015

Picture	No.	Partname And Description	Part Number
		KEYBOARD DARFON NORWAY NSK-A640N 85KEYS	KB.T2507.016
		KEYBOARD DARFON DANISH NSK-A640D 85KEYS	KB.T2507.017
LCD			
	1	LCD MODULE 15" TFT SXGA+ HSD 150PK17 W/ANTENNA	6M.FR1V7.002
		LCD MODULE 15" TFT SXGA+ CMO IDT N150P3 W/ANTENNA	6M.FR1V7.003
	NS	LCD 15" TFT SXGA+ HSD 150PK17	LK.15007.007
		LCD 15" TFT SXGA+ CMO IDT N150P2-L04	LK.1500D.003
	NS	INVERTER BOARD W/MAYLAR E SUMIDA 53261-0590	19.T23V7.011
	NS	LCD BRACKET 15" RIGHT W/HINGE	33.T23V7.007
	NS	LCD BRACKET 15" LEFT W/HINGE	33.T23V7.008
	NS	LCD PANEL WITH LOGO-15"	60.FR1V7.003
	NS	LCD BEZEL 15"	42.FR1V7.006
	NS	LCD COAXIAL CABLE FOR 15" XGA spwg-B	50.T23V7.021

Picture	No.	Partname And Description	Part Number
Main Board			
	9	MAINBOARD 128MB VGA W/SMART CARD READER,PCMCIA SLOT,W/O CPU MEMORY	MB.FR106.001
	NS	PCMCIA SLOT	22.A13V7.001
Memory			
	NS	256MB DDR333 HYS64D32020GDL-6-B INFINEON	KN.25602.009
		256MB DDR333 NT256D64SH8BAGM-6K NANYA	KN.25603.009
		256MB DDR333 MT8VDDT3264HDG-335C3 MICRON	KN.25604.009
		256MB DDR333 M470L3224DT0-CB300 SAMSUNG	KN.2560B.005
		256MB DDR333 W30256AAEPI652A ELPIDA	KN.25609.002
		512MB DDR333 HYS64D64020GBDL-6-B INFINEON	KN.51202.007
		512MB DDR333 NT512D64S8HBAFM-6K NANYA	KN.51203.005
		512MB DDR333 EBD52UC8AARA-6B ELPIDA	KN.51209.002
Optical Drive			
	11	DVD DUAL MODULE 4X PIONEER DVR-K12RA	6M.FR1V7.001
	NS	DVD DUAL 4X PIONEER DVR-K12RA	KU.00405.005
	NS	DVD DUAL BEZEL FOR PIONEER	42.FR1V7.004
	NS	OPTICAL DEVICE BRACKET	33.A13V7.002
Pointing Device			
	NS	TOUCHPAD	56.FR1V7.001

Picture	No.	Partname And Description	Part Number
Speaker			
	14	SPEAKER SET	6K.T23V7.002
Heatsink			
	7	HEATSINK W/FAN	6K.T23V7.003
	NS	VGA HEATSINK	34.A13V7.001
	NS	VGA MEMORY HEATSINK	34.A13V7.002
Reader			
	NS	4 IN 1 READER	6K.T29V7.001
Microphone			
	NS	MICROPHONE	23.T23V7.001
Others			
	NS	LCD LATCH W/O SPRING	6K.FR1V7.001
	NS	LCD SCREW RUBBER UPPER	47.FR1V7.001
	NS	LCD SCREW RUBBER LOWER	47.FR1V7.002
Screws			
	NS	NUT-I/O	86.T23V7.001
	NS	SCREW M1.6X4.0-I-NI-NYLOK	86.T23V7.002
	NS	SCREW M2.0X2.5-I-NI-NYLOK	86.A03V7.007
	NS	SCREW M2.0X3.0-I-NI-NYLOK	86.A03V7.012
	NS	SCREW M2.0X3.5-I-NI-NYLOK	86.T23V7.005
	NS	SCREW M2.0X5-I-NI-NYLOK	86.T23V7.006
	NS	SCREW M2.5X3-I-NI-NYLOK	86.A03V7.010
	NS	SCREW M2.5X4.0-B-NI-NYLOK	86.T23V7.008
	NS	SCREW M2.5X4-I-NYLOK	86.T23V7.009
	NS	SCREW M2.5X5.0-I-NI-NYLOK	86.T23V7.010
	NS	SCREW M2.5X5.5-P-NI-NYLOK	86.T23V7.011
	NS	SCREW M2.5X0.45+7I-NYLOK	86.T23V7.012
	NS	SCREW M1.7X3.5-I-BZN	86.A03V7.009
	NS	SCREW M2X3-I-BNI-NYLOK	86.T23V7.014
	NS	SCREW M2.0X5.0-I-BNI-NYLOK	86.T23V7.015
	NS	SCREW M2.0X6.0-I-NI-NYLOK	86.T23V7.017
	NS	SCREW M2.5X2-I-NI-NYLOK	86.T23V7.018
	NS	SCREW M2.5X4-I-BNI	86.T23V7.019

Model Definition and Configuration

Ferrari 3000 Series

Model Number	CPU	LCD	Memory	HDD (GB)	ODD	Card Reader	Wireless LAN
3000LMi	Athlon XP 2500+ 40W	15.0" SXGA+	DDR333 2x256MB	60	2.4x DVD-Dual	4 in 1	11g

Test Compatible Components

This computer's compatibility is tested and verified by Acer's internal testing department. All of its system functions are tested under Windows® XP Home.

Refer to the following lists for components, adapter cards, and peripherals which have passed these tests. Regarding configuration, combination and test procedures, please refer to the Ferrari 3000 series Compatibility Test Report released by the Acer Mobile System Testing Department.

Microsoft® Windows® XP Home Environment Test

Item	Specifications
Display	LCD: Acer AL722 Compaq TFT 5004 Phillips Brilliance 150P CRT: Dell Trinitron 21" ViewSonic GS773 ViewSonic GS790 ViewSonic PF775 Phillips Brilliance 109P 19"
Parallel Port	Printer: HP Laser Jet 5M HP Desk Jet 840C HP Laser Jet 2100 Canon BJC-3000 IOMega ZIP 100 (LPT Port) IOMega ZIP 250 (LPT Port) Cable: ECP Cable (LL5)
1394 Port	1394 HDD/IEEE 1394 (Fire Wire)/USB 1.1 Combo Hard Drive 1394 External HDD CASE 1394 CCD (APLUX C102T) 1394 MO: FUJITSU LIMITED MDF3130EE 1394 Cable P to P(Pci)
Projector	Panasonic PT_L757U Panasonic PT_L556EA
USB 2.0	USB HUB: Highspeed4 Port USB HDD: Billionton USB CD-RW: YAMAHA CD/RW-70 USB C.F. Card Reader: IOGEAR\ GFR201 USB 6 in 1 Card Reader: SanDisk ImageMate 6 in 1 USB DVD/CD-RW: Pioneer DVR-104 USB DVD/CD-RW: Ricoh MP5125A USB Memory: USB Drive 128MB
GB LAN HUB	3 COM SUPER STACK II \ 3C16611 24port
S-Video	TV: Sony Trinitron 14" \ PVM-14M4U Sony Trinitron 14" \ PVM-14M2U

Item	Specifications
PC Cards	<p>Modem Card: 3Com 56K Modem (3CXM756) Xircom 56K Modem (CM-56) Xircom 56K Modem (CM-56G) Billinton 56K Modem (FM56C-BF) Psion-Gold Card Clabal 56K+Fax</p> <p>LAN Card: 3Com Lan Card (3CCFE574BT) D-Link Fast Ethernet DFE-650 D-Link CardBus DFE-660 3COM 10M CardBus LAN Card (3CCFE589ET) Xircom CreditCard Ethernet 10/100 (CE3B-100) Pci_Fast Ethernet Card FNW-3602-TX</p> <p>LAN Card Bus Card: 3COM 10/100 CardBus LAN Card (3CCFE575CT) Xircom CardBus Ethernet II 10/100 (CBE2-100)</p> <p>SCSI: Adaptec SlimSCSI APA-1460D Card</p> <p>LAN + Modem Card: Xircom CreditCard Ethernet + Modem 56K (CEM56-100)</p> <p>ATA Card: Adapter Flash Card+ SanDisk CF Card 128MB PQI Compact Flash Card+ PQI CF Card 128MB</p> <p>Zip Card: ZIOMEGA USB ZIP 250</p> <p>1394 CardBus Card: IEEE 1394 CardBus Card\ DV Megician \UPMOST</p> <p>Wireless LAN Card: CISCO AIRONET 350 SERIESAIR-PCM350 Quanta Wireless LAN Card \ WL-211F Wireless Card Bus Card: BUFFALD WLI-CB-G54A</p> <p>Card Reader: Apapter PCMCIA 4 in 1 PQI CF CARD Reader PNY PCMCIA 4 in 1</p> <p>MMC Card: SanDisk 32MB SanDisk 64MB PQI 64MB</p> <p>MS Card: Apacer 128MB SONY Memory Stick 128MB</p> <p>SD Card: Transcend 128MB SanDisk 128MB</p> <p>CF Card: PQI 128MB SanDisk 8MB SanDisk 128MB</p>

Item	Specifications
USB Port	<p>K/B+Mouse Logitech K/B+Mouse+Receiver Microsoft Wireless Optical DeskTop for Bluetooth K/B+Mouse</p> <p>USB Mouse: Microsoft IntelliMouse Optical USB & PS2 Compatible Microsoft Notebook Optical Mouse Microsoft Optical Mouse Blue USB & PS/2 Compatible\MIC:E-C011-02-1620 Logitech Wheel Mouse M-BB48 Logitech MouseMan Dual Optical \ M/N:M-BL63B Logitech iFEEL Mouse M-UN58a Acer USB Mouse MP0930 Acer USB Mouse M012B0</p> <p>USB Keyboard: NMB K/B ZIPPY USB Keypad TK532</p> <p>USB Camera: Intel YC72 Logitech QuickCam Home Dlink WebCam DSB-C300</p> <p>USB HDD: HD 530 Tested to comply with FCC Standards</p> <p>USB CD-ROM: YAMAHA CD/RW-70</p> <p>USB Printer: HP DiskJet 3425 Colour inKlet printer HP DeskJet 840C HP deskject 450 Canon BJC-3000</p> <p>USB FDD: Acer USB FDD YD-8U10 Teac USB FDD Logitec USB FDD</p> <p>USB Memory: USB DRIVE 128MB Panasonic SUPER DISK \ LKRF235U</p> <p>USB LAN: Billionton USB-10/100 FastEthernet BUFFALO USB-10/100M Ethernet LUX-TX</p> <p>USB Zip: IOMEGA USB ZIP 100 IOMEGA USB ZIP 250</p> <p>USB Scanner: HP ScanJet 5300c</p> <p>USB Speaker: Philips USB Speaker (DIGITAL Speaker System)</p> <p>USB HUB: PCI_USB HUB\UH-400</p> <p>USB Gamepad: Logitech WingMan GAMEPAD EXTREME Logitech WingMan EXTREME DIGITAL 3D Logitech WingMan RUMBLEPAD</p> <p>USB Card Reader: Iwill 6 in 1 Card Reader Pro Compact Flash Card Reader</p>

Item	Specifications
Audio Jacks	Speaker DENON Amplifier (AMP) AVR-1802 LOUDSPEAKER Gateway Speaker Earphone: AIWA HP-X121 Earphone PHILIPS Earphone NEC Earphone e STEREO DYNAMIC HEADPHONES E-750 Pro. 2 DYNAMIC HEADPHONES PH-B333G Panasonic Stereo Headphones \ RP-H1245 DELL harman/kardon
Microphone	AIWA Mini Microphone Condenser MIC. EM-420T
Audio Jack	JS-100 Jazz 3D Speaker SONY Earphone MDR-CD60 Microsoft microphone
Microphone	Condenser Microphone Dynamic Microphone

Online Support Information

This section describes online technical support services available to help you repair your Acer Systems.

If you are a distributor, dealer, ASP or TPM, please refer your technical queries to your local Acer branch office. Acer Branch Offices and Regional Business Units may access our website. However some information sources will require a user i.d. and password. These can be obtained directly from Acer CSD Taiwan.

Acer's Website offers you convenient and valuable support resources whenever you need them.

In the Technical Information section you can download information on all of Acer's Notebook, Desktop and Server models including:

- Service guides for all models
- User's manuals
- Training materials
- Bios updates
- Software utilities
- Spare parts lists
- TABs (Technical Announcement Bulletin)

For these purposes, we have included an Acrobat File to facilitate the problem-free downloading of our technical material.

Also contained on this website are:

- Detailed information on Acer's International Traveler's Warranty (ITW)
- Returned material authorization procedures
- An overview of all the support services we offer, accompanied by a list of telephone, fax and email contacts for all your technical queries.

We are always looking for ways to optimize and improve our services, so if you have any suggestions or comments, please do not hesitate to communicate these to us.

A

ACPI 1.0a 22
 AFLASH Utility 44
 Audio 25

B

Battery Pack 50
 BIOS 22

- package 22
- password control 22
- ROM size 22
- ROM type 22
- vendor 22
- Version 22

 BIOS Setup Utility 31
 BIOS Supports protocol 22
 BIOS Utility 31

- Basic System Settings 36
- Navigating 32
- Onboard Device Configuration 39
- Startup Configuration 38
- System Information 32
- System Security 43

 Board Layout 4

- Bottom View 5
- Top View 4

C

Cache

- controller 22
- size 22

 caps lock

- on indicator 12

 CardBus 27
 CPU

- core voltage 22
- package 22
- type 22

D

DIMM 22

- Combinations 23
- external 51
- package 22
- removing 51
- Speed 22
- voltage 22

 Disassembly

Battery Pack 48
 CD-ROM/DVD-ROM Module 53
 Floppy Disk Drive 57
 Procedure Flowchart 47

Display 3

E

Error Symptom-to-Spare Part Index 65
 External CD-ROM Drive Check 62
 External Diskette Drive Check 62

F

Features 1
 Flash Utility 44
 Floppy Disk

- removing the 57

 FRU (Field Replaceable Unit) List 81

H

Hot Keys 13

I

Indicators 12
 Intermittent Problems 76

J

Jumper and Connector Locations 79

- Top View 79

K

Keyboard 28
 Keyboard or Auxiliary Input Device Check 62

L

L2 cache 22

M

Memory Check 63
 Model Definition 90
 Modem 23

N

num lock

- on indicator 12

O

P

Panel 6

- Bottom 11
- left 6
- Rear 9
- right 9

Parallel Port 26

PC Card 12, 27

PCMCIA 27

Pentium III 22

Power System Check 63

- Battery Pack 64

Processor 22

R

RMA 81

S

Second Level Cache 22

System

- Block Diagram 3
- Layout 4

System Diagnostic Diskette 44

System Memory 22

System Utilities 31

System Utility Diskette 44

T

Test Compatible Components 91

Touchpad Check 64

Troubleshooting 61

U

Undetermined Problems 77

USB 27

utility

- BIOS 31

V

Video 26

W

Windows XP Pro Environment Test 92

