

8

7

6

5

4

3

2

1

- 1. ALL RESISTANCE VALUES ARE IN OHMS, 0.1 WATT +/- 5%.
- 2. ALL CAPACITANCE VALUES ARE IN MICROFARADS.
- 3. ALL CRYSTALS & OSCILLATOR VALUES ARE IN HERTZ.

M87/M88 LED DRIVER BOARD

Making DOH-SPRINT have less parts
PVT:12/07]/2007

REV	ZONE	ECN	DESCRIPTION OF CHANGE	CK APPD	ENG APPD
A		551172	PRODUCTION RELEASED	DATE	DATE
				12/07/07	?

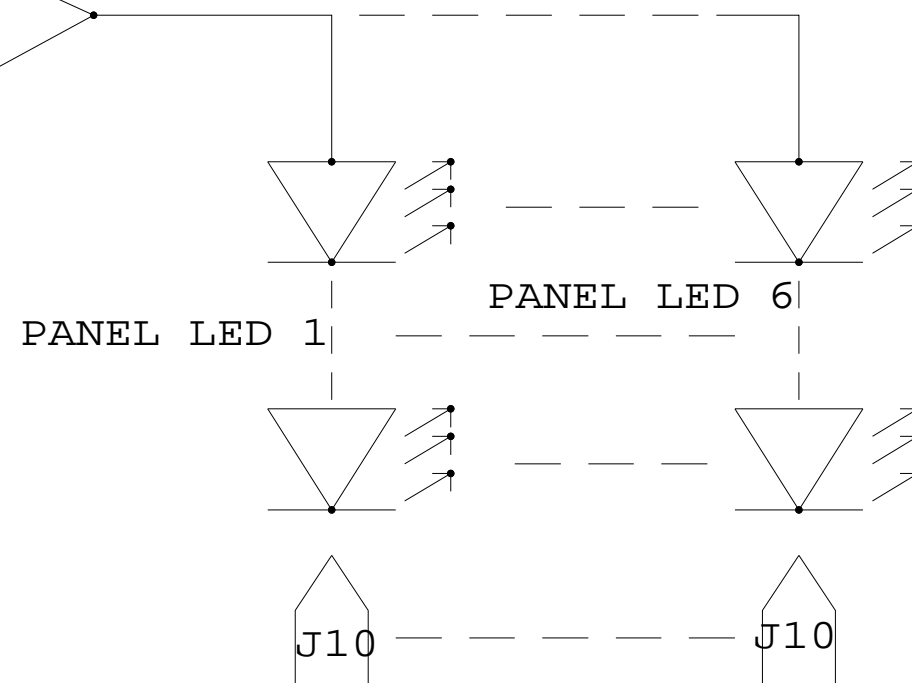
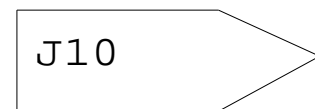
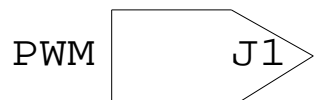
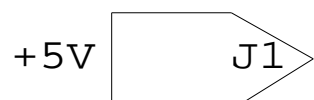
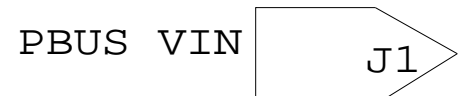

PART NUMBER	QTY	DESCRIPTION	REFERENCE DES	CRITICAL	BOM OPTION
051-7482	1	SCHEM, LED, M87-M88, MBP15/17	SCH1	CRITICAL	
820-2297	1	PCBF, LED, M87-M88, MBP15/17	PCB1	CRITICAL	
000-0041	1	PLACEHOLDER FOR EEE/CCC INFO	[EEE:Z3E]	CRITICAL	

DIMENSIONS ARE IN MILLIMETERS		METRIC		APPLE INC.	
XX :	_____	DRAPTER	/	DESIGN CK	/
X.XX :	_____	ENG APPD	/	MFG APPD	/
X.XXX :	_____	QA APPD	/	DESIGNER	/
ANGLES :	_____	RELEASE	/	SCALE	NONE
DO NOT SCALE DRAWING		MATERIAL/FINISH NOTED AS APPLICABLE		SIZE	D
THIRD ANGLE PROJECTION		DRAWING NUMBER		051-7482	REV. A
		TITLE		SCHEM, LED, M87-M88, MBP15/17	
		SHT		1 OF 3	

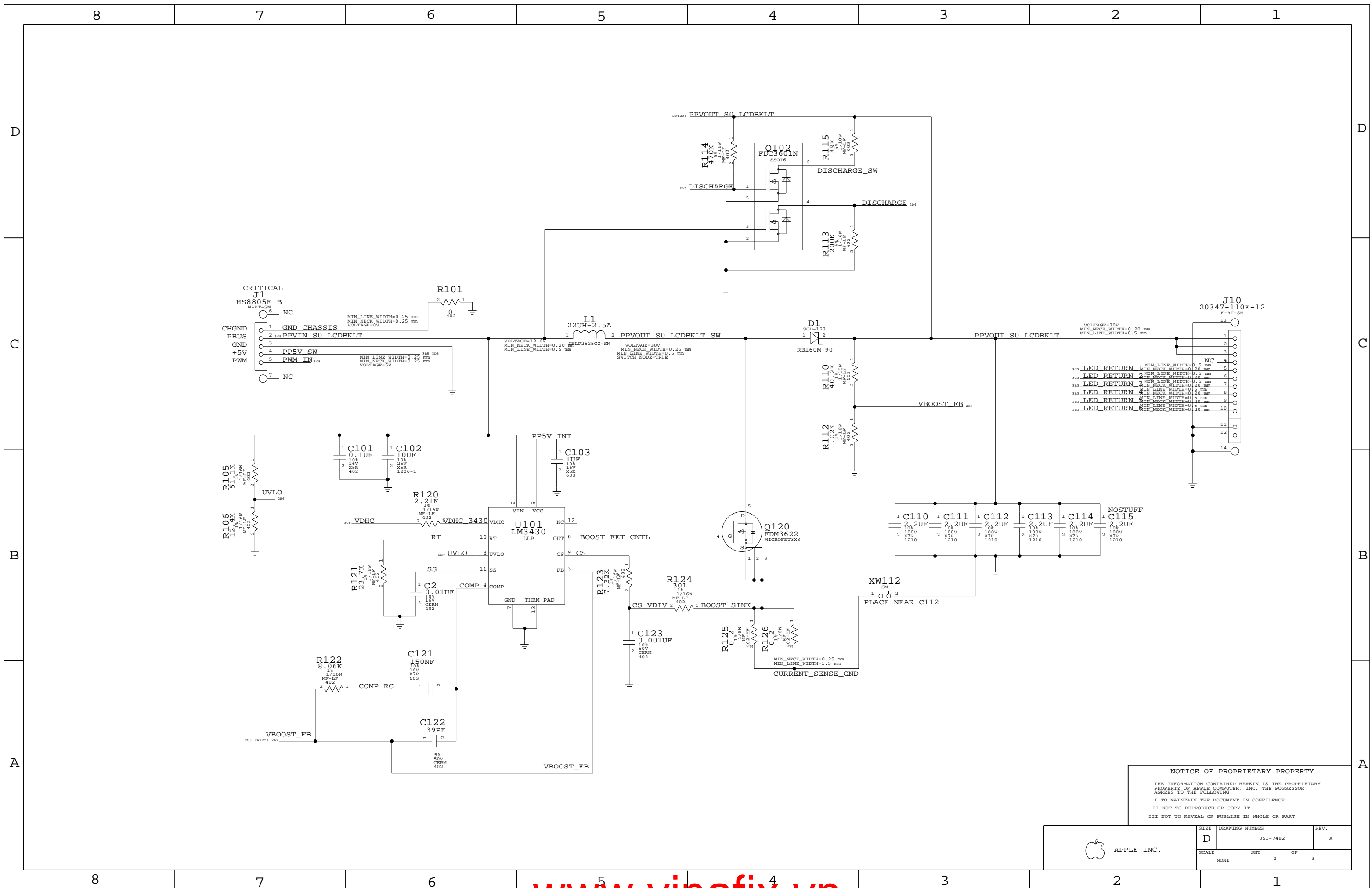

NOTICE OF PROPRIETARY PROPERTY
 THE INFORMATION CONTAINED HEREIN IS THE PROPRIETARY PROPERTY OF APPLE COMPUTER, INC. THE POSSESSOR AGREES TO THE FOLLOWING
 I TO MAINTAIN THE DOCUMENT IN CONFIDENCE
 II NOT TO REPRODUCE OR COPY IT
 III NOT TO REVEAL OR PUBLISH IN WHOLE OR PART

APPLE INC.	SIZE	DRAWING NUMBER	REV.
	D	051-7482	A
SCALE	SHT		OF
NONE	2		3

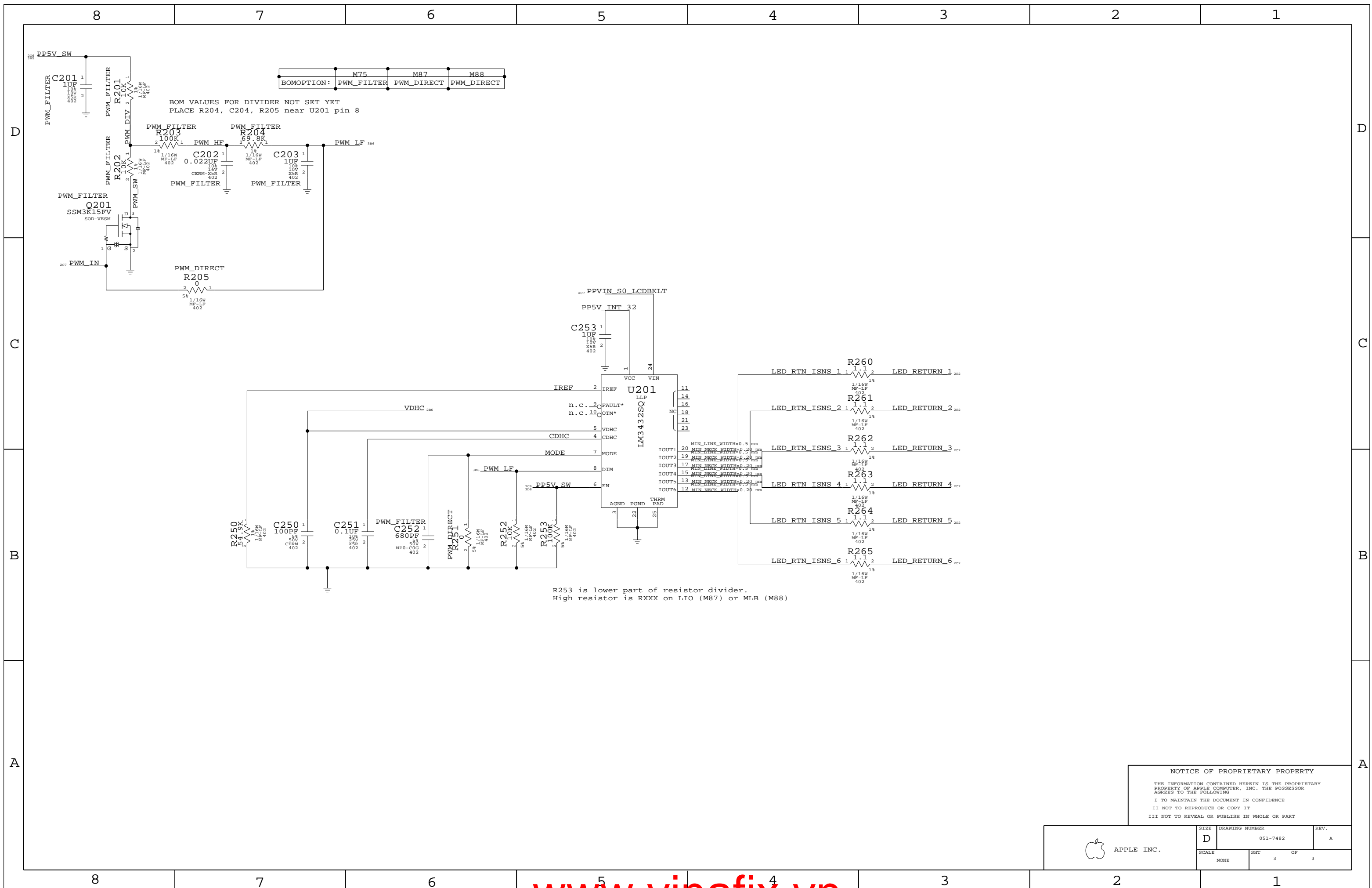

NOTICE OF PROPRIETARY PROPERTY

THE INFORMATION CONTAINED HEREIN IS THE PROPRIETARY PROPERTY OF APPLE COMPUTER, INC. THE POSSESSOR AGREES TO THE FOLLOWING

I TO MAINTAIN THE DOCUMENT IN CONFIDENCE

II NOT TO REPRODUCE OR COPY IT

III NOT TO REVEAL OR PUBLISH IN WHOLE OR PART

APPLE INC.	SIZE	DRAWING NUMBER	REV.
	D	051-7482	A
SCALE	SHT	OF	3
NONE	3		