

# TAOS 2.0

## MV Build - Final

05/09/2006

	1	2	3	4	5	6	7	8
A								
B								
C								
D								
E								
F								

DATE	CHANGE NO.	REV

DRAWER	EE	DATE	POWER	DATE	<b>INVENTEC</b>			
DESIGN								
CHECK								
RESPONSIBLE								
TITLE <b>TAOS20</b>								
SIZE =	3	VER :			SIZE <b>A3</b>	CODE <b>CS</b>	DOC. NUMBER <b>1310A20305</b>	REV <b>A02</b>
FILE NAME :	XXXX-XXXXXX-XX							
P/N	XXXXXXXXXXXX							
					SHEET	1	OF	69

## Table Of Content

PAGE	PAGE	PAGE
5- DC& Battery Charger	29- Blank	53- USB CONN (USB_1394 DB)
6- Selector & Battery CONN	30- Blank	54- CardBus Controller
7- +V5A, +V3A & +V1.8S	31- Blank	55- PC Card Slot
8- OCP	32- Blank	56- 6 IN 1 Card CONN
9- +VCC_NB & V1.2S	33- Blank	57- 1394 CONN (USB_1394 DB)
10- +VCC_CORE	34- Blank	58- MiniCard (WLAN)
11- DDR2 & V2.5 & +V1.5S	35- CRT& S-Vedio CONN	59- LAN Interface
12- Power(Sleep)	36- LCD CONN	60- LAN RJ45 CONN
13- Power(Sequence)	37- SB450-1	61- Docking CONN
14- Blank	38- SB450-2	62- Screw
15- Clock Generator	39- SB450-3	63- MDC CONN
16- AMD CPU-1	40- SB450-4	64- Finger Print DB
17- AMD CPU-2	41- SB450-5	65- BlueTooth
18- AMD CPU-3	42- KBC	66- Power/LID Switch & LED
19- AMD CPU-4	43- FWH (1M) & Accelero-Meter (NI)	67- Blank
20- Thermal & Fan Controller	44- INT. KBC/Touch Pad Devices	68- LED/Switch Botton DB
21- RS485MH / RS480M -1	45- Super I/O	
22- RS485MH / RS480M -2	46- Blank	
23- RS485MH / RS480M -3	47- TPM V1.2	
24- RS485MH / RS480M -4	48- AZALIA CODEC	
25- RS485MH / RS480M -5	49- Earphone & MIC JACK	
26- DDR2-DIMM0	50- Audio AMP & INT. Speaker CONN	
27- DDR2-DIMM1	51- HDD CONN (SATA)	
28- DDR2-DAMPING	52- Fixed ODD CONN (PATA)	

**INVENTEC**

TITLE TAOS20

SIZE A3	CODE CS	DOC. NUMBER 1310A20305	REV A02
------------	------------	---------------------------	------------

CHANGE by *Drawer Name* 20-Apr-2006

SHEET 2 OF 69

# Inventec Confidential

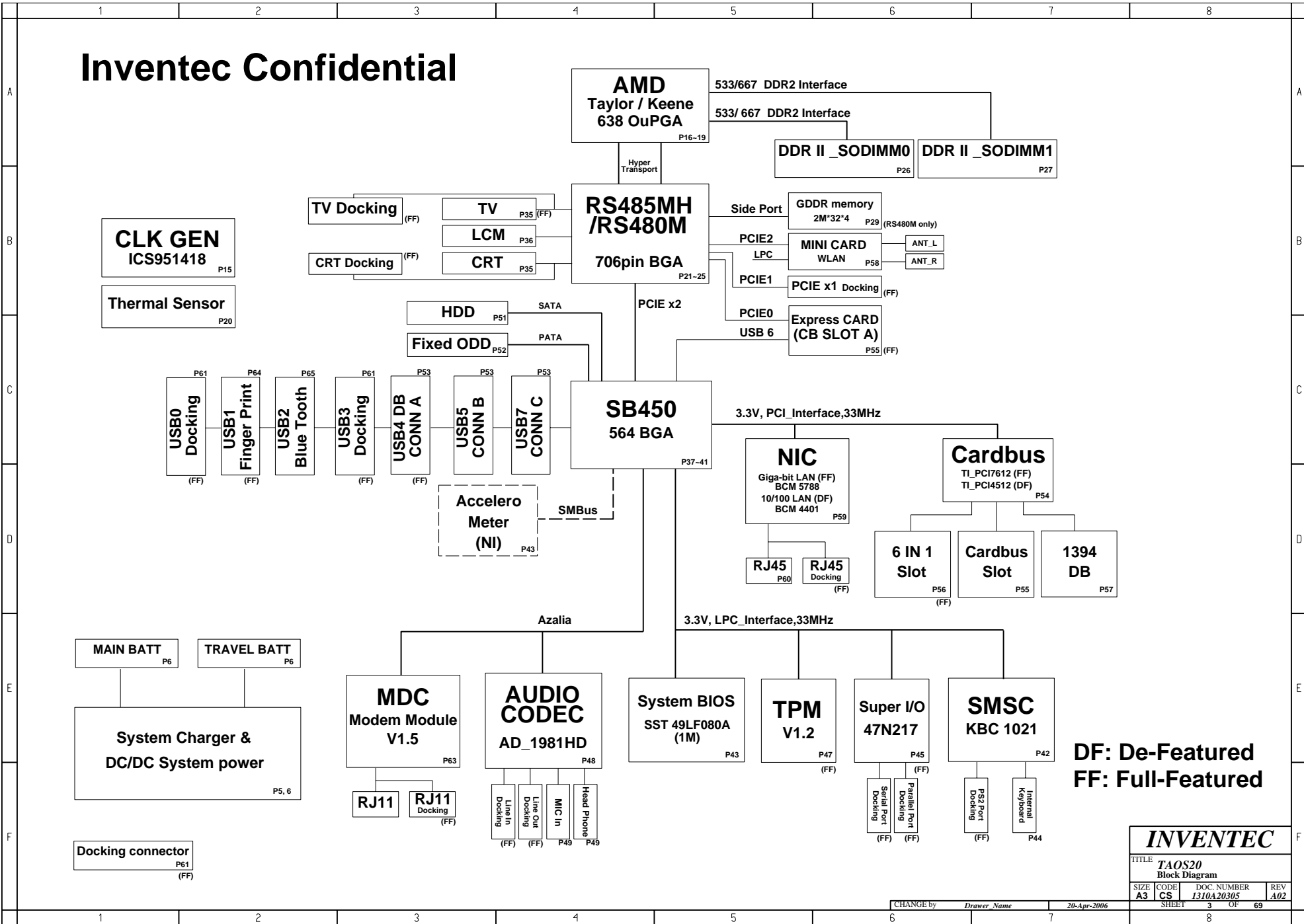

DF: De-Featured  
FF: Full-Featured

<b>INVENTEC</b>			
TITLE TAOS20 Block Diagram			
SIZE A3	CODE CS	DOC. NUMBER 1310A20305	REV A02
CHANGE by Drawer Name		20-Apr-2006	SHEET 3 OF 69

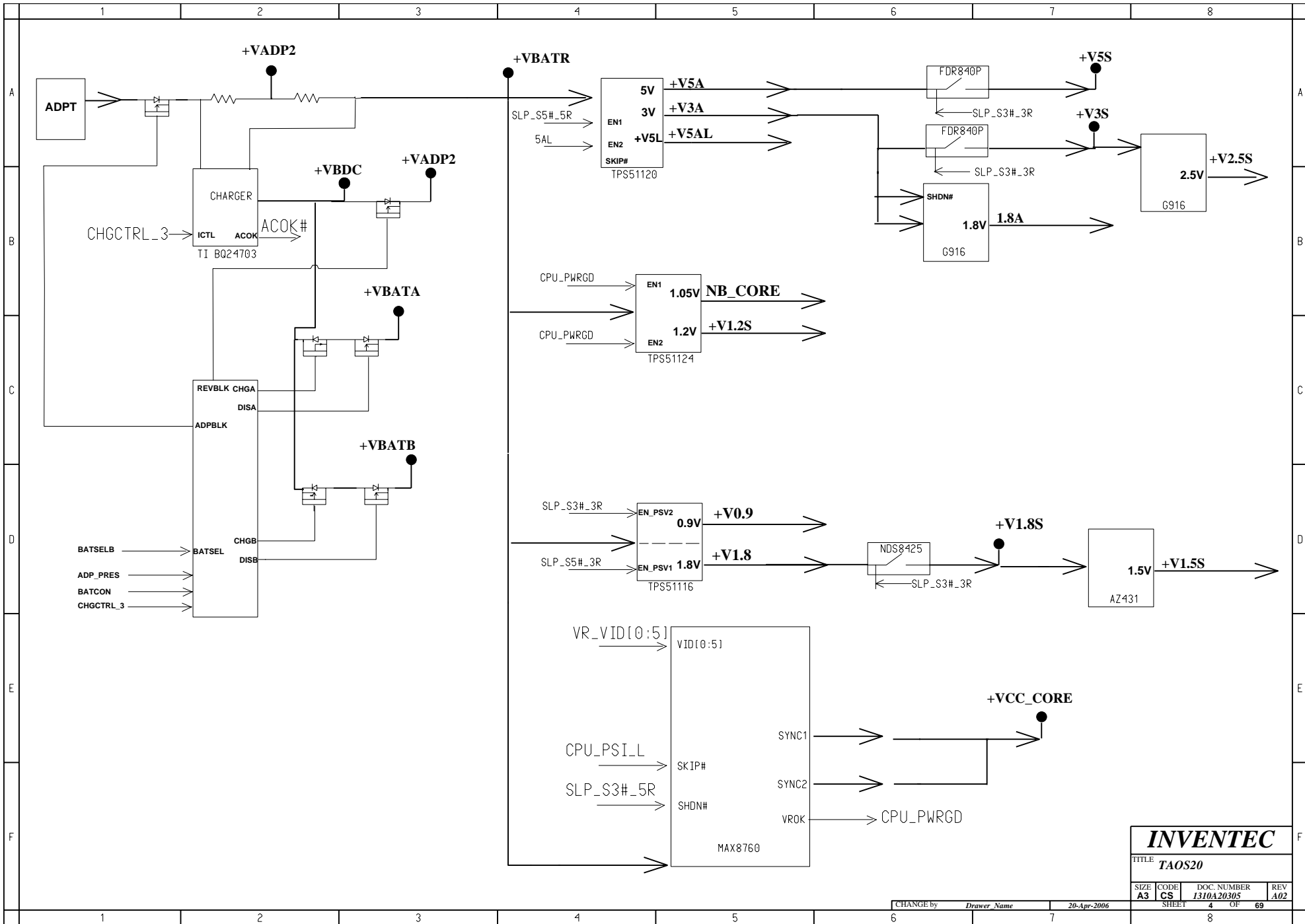

<b>INVENTEC</b>			
TITLE <b>TAOS20</b>			
SIZE <b>A3</b>	CODE <b>CS</b>	DOC. NUMBER <b>1310A20305</b>	REV <b>A02</b>
CHANGE by <i>Drawer Name</i>		20-Apr-2006	
SHEET <b>4</b>		OF <b>69</b>	

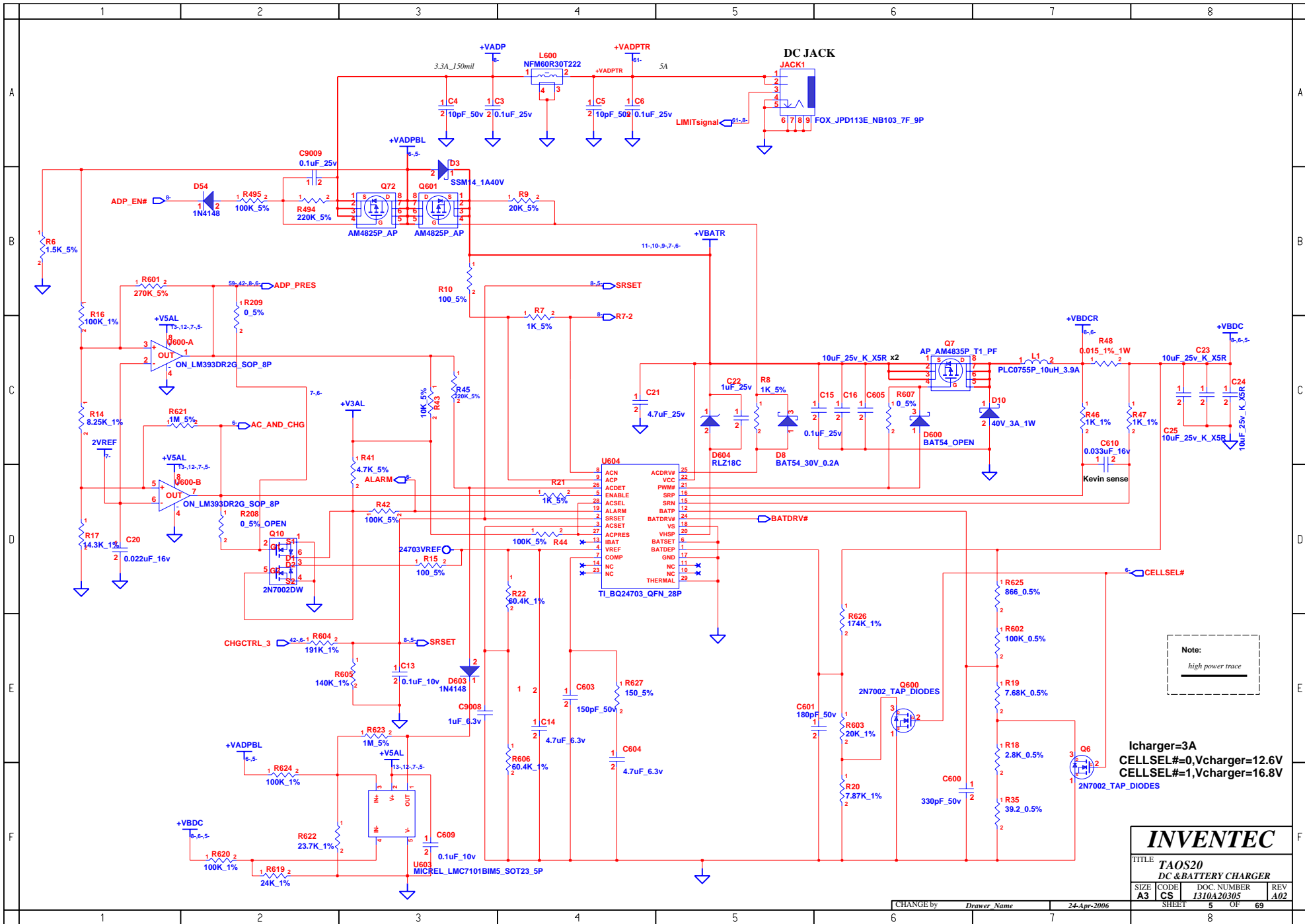

Note:  
high power trace

Icharger=3A  
CELLSEL#=0,Vcharger=12.6V  
CELLSEL#=1,Vcharger=16.8V

<b>INVENTEC</b>			
TITLE TAOS20 DC & BATTERY CHARGER			
SIZE A3	CODE CS	DOC NUMBER I310A20305	REV A02
CHANGE by Drawer Name		24-Apr-2006	
SHEET 5		OF 69	

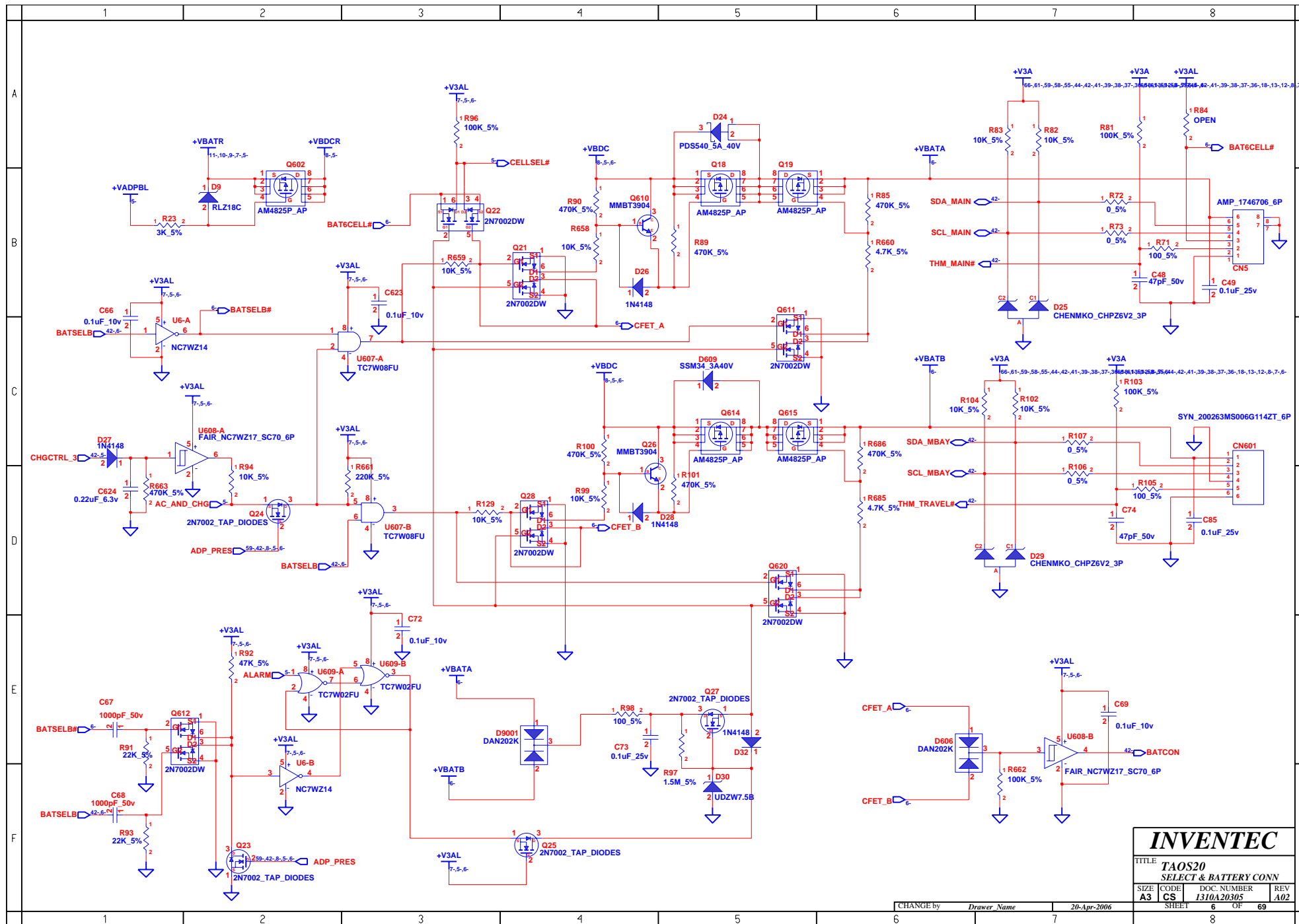

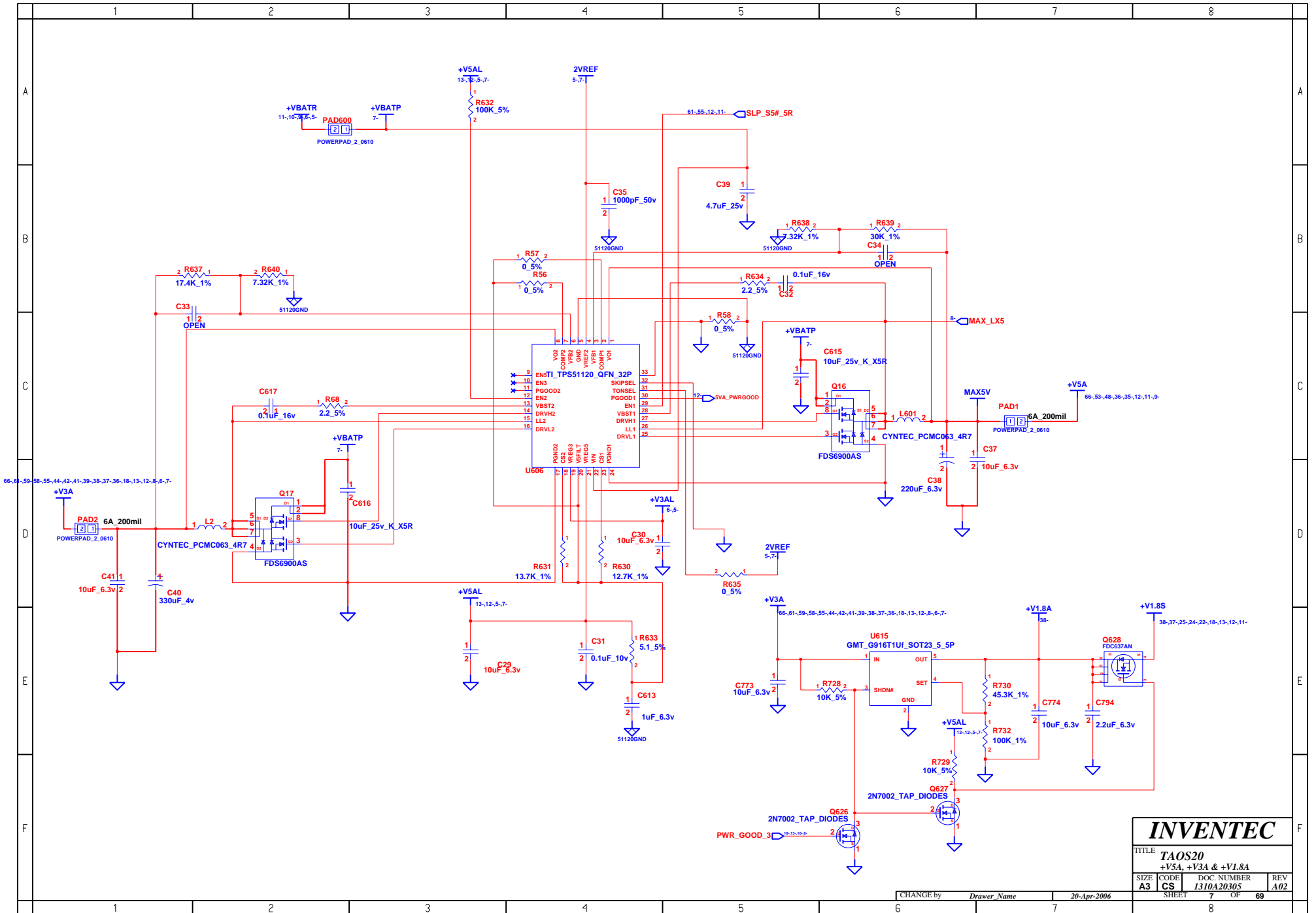

<b>INVENTEC</b>			
TITLE TAOS20			
+V5A, +V3A & +V1.8A			
SIZE A3	CODE CS	DOC. NUMBER 1310A20305	REV A02
CHANGE by		Drawer Name	20-Apr-2006
SHEET 7		OF 69	

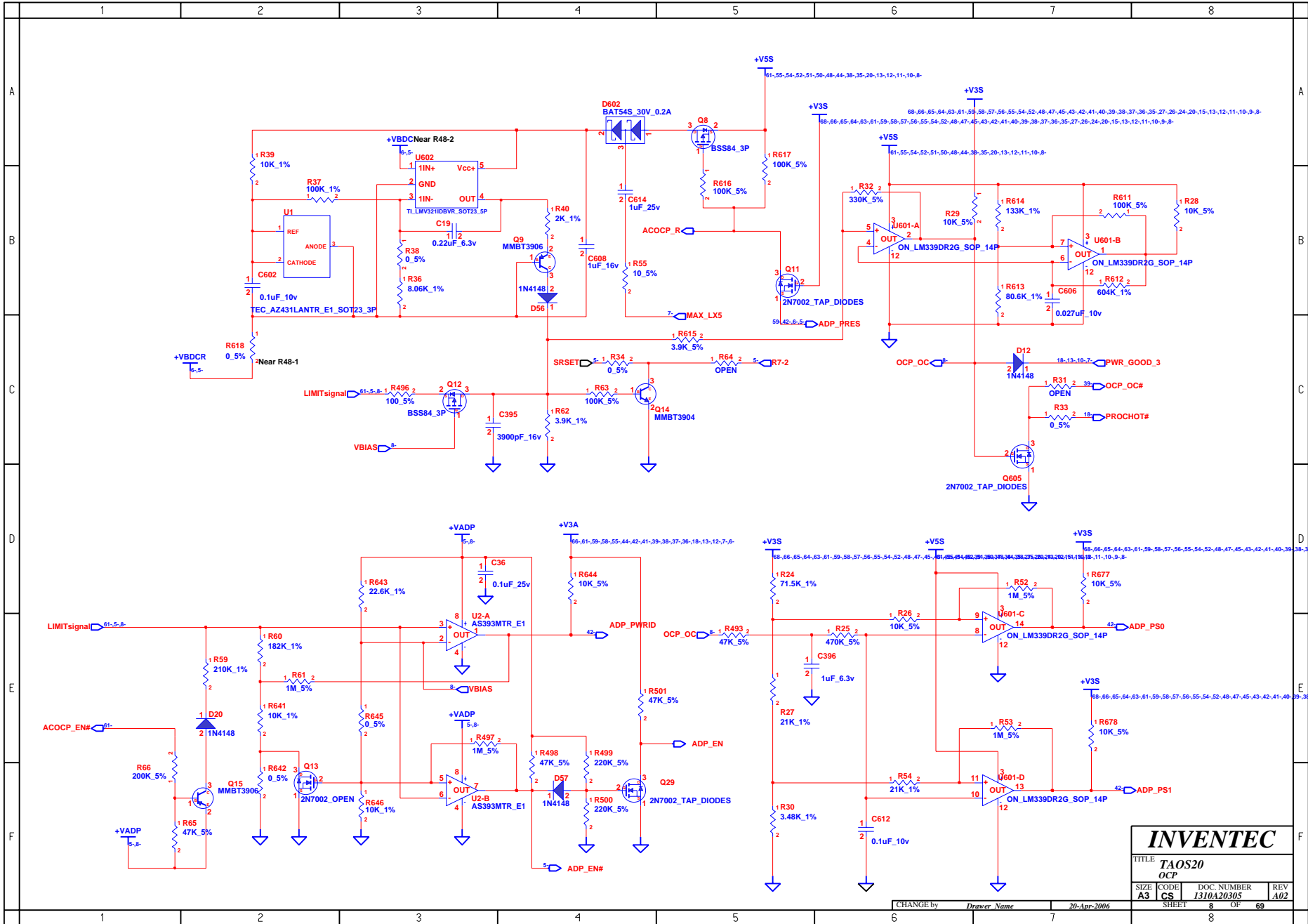

<b>INVENTEC</b>			
TITLE TAOS20			
OC			
SIZE	CODE	DOC. NUMBER	REV
A3	CS	I310A20305	A02
CHANGE by		DRAWER Name	
		20-Apr-2006	
		SHEET 8 OF 69	



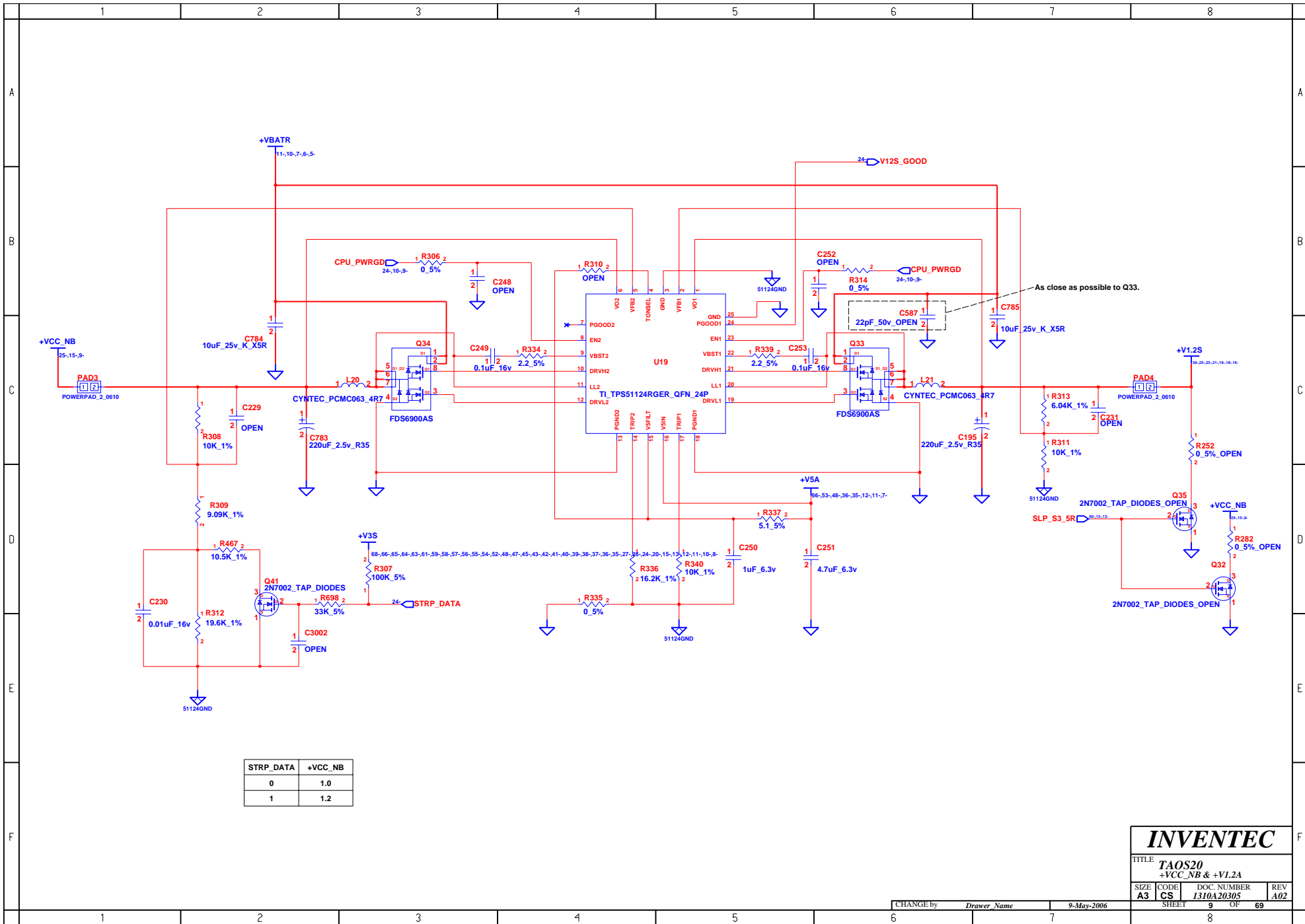

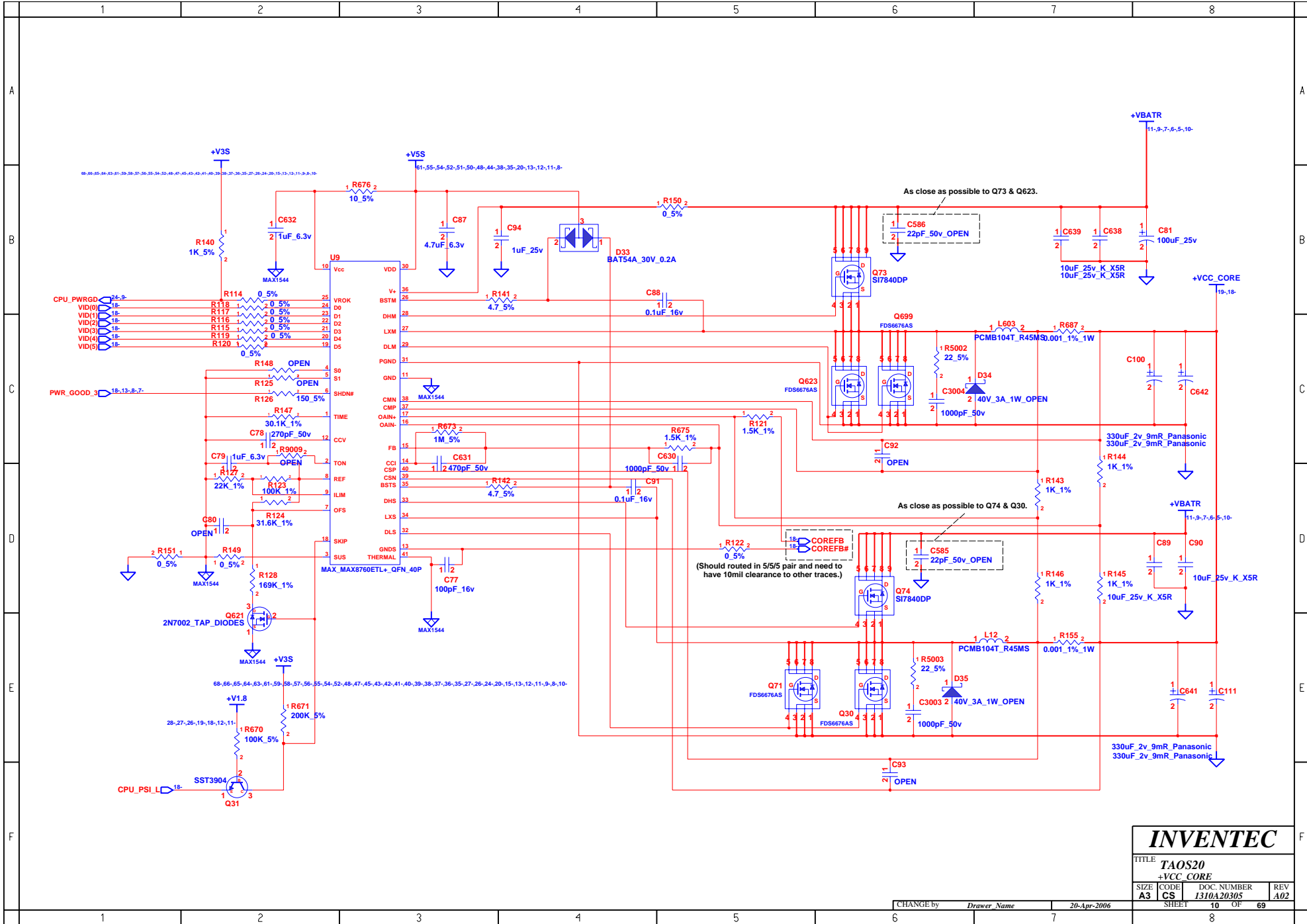

# INVENTEC

TITLE			
TAOS20			
+VCC CORE			
SIZE	CODE	DOC. NUMBER	REV
A3	CS	I310A20305	A02

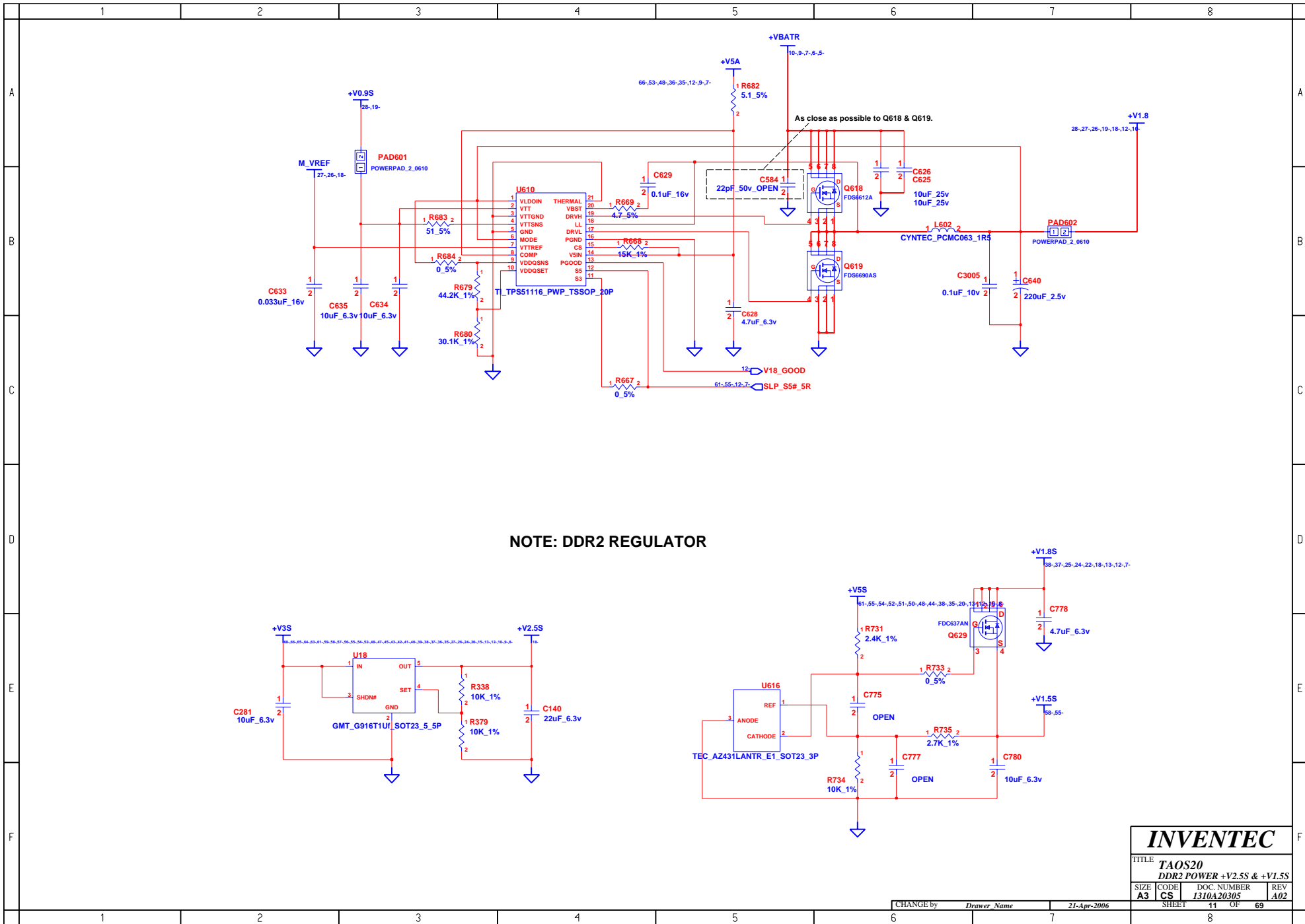

<b>INVENTEC</b>			
TITLE <b>TAOS20</b>			
DDR2 POWER +V2.5S & +V1.5S			
SIZE <b>A3</b>	CODE <b>CS</b>	DOC. NUMBER <b>I310A20305</b>	REV <b>A02</b>
CHANGE by <i>Drawer Name</i>		21-Apr-2006	
SHEET 11		OF 69	

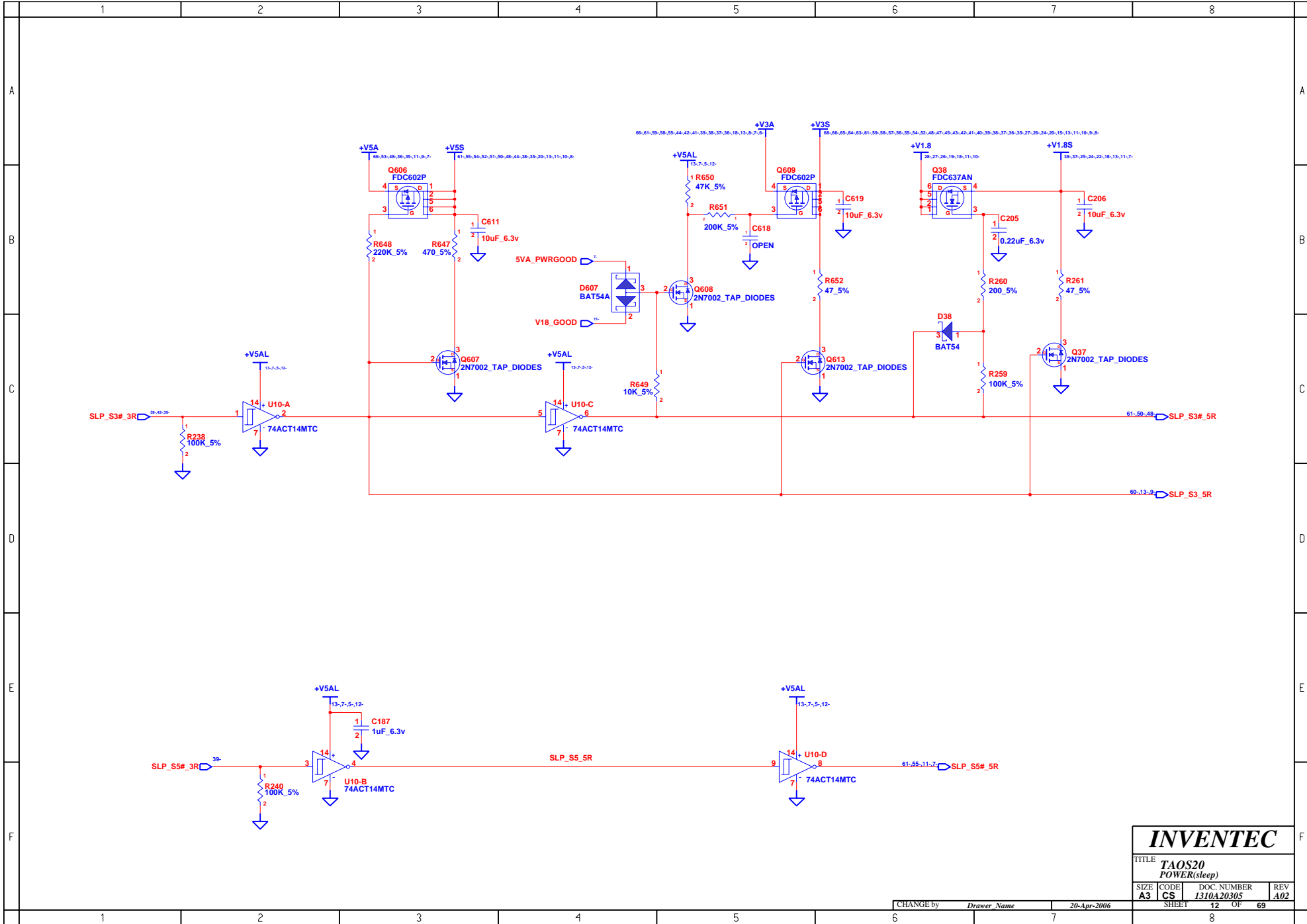

**INVENTEC**

TITLE			
TAOS20 POWER(sleep)			
SIZE	CODE	DOC. NUMBER	REV
A3	CS	I310A20305	A02

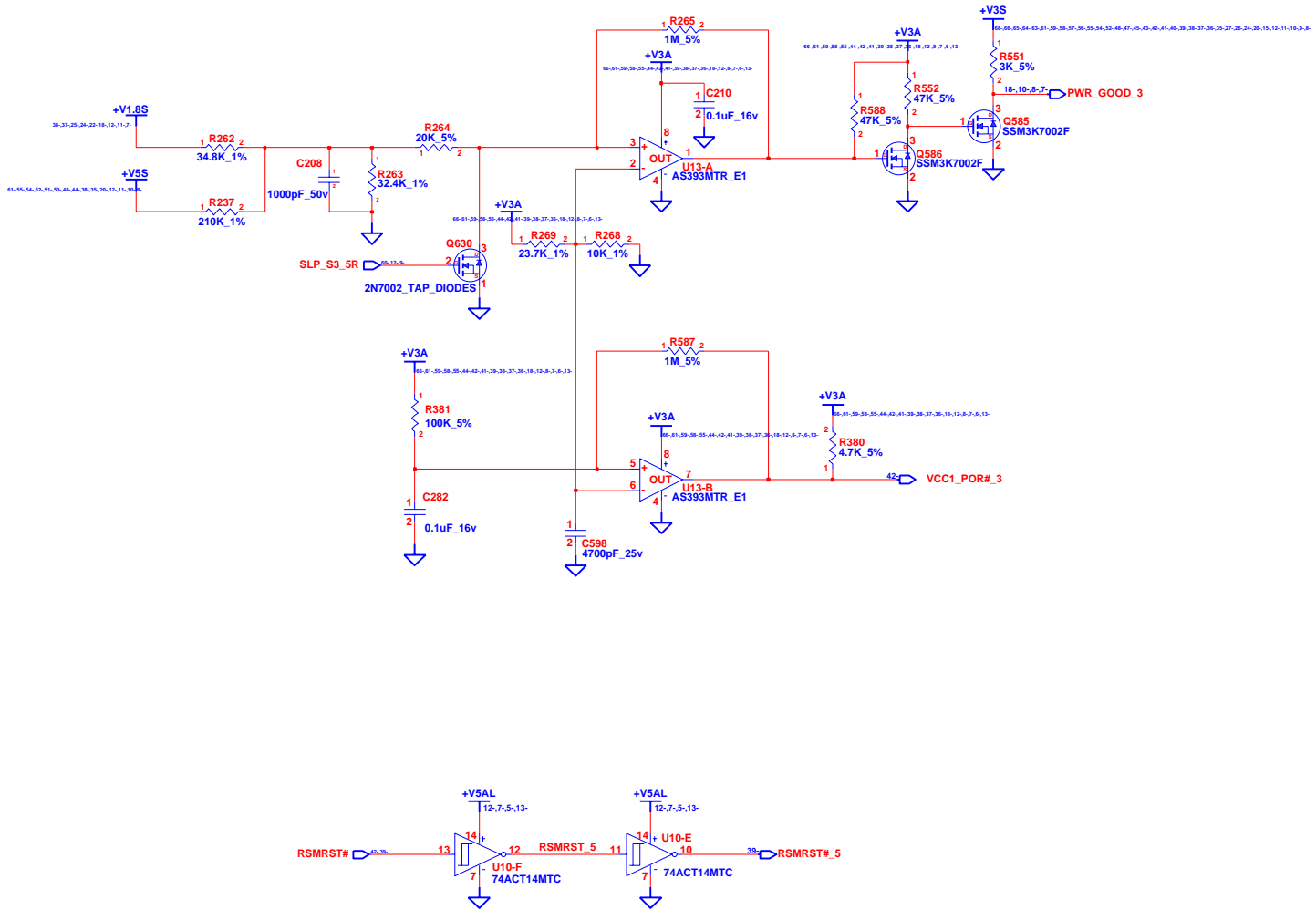

# INVENTEC

TITLE			
TAOS20			
POWER(Sequence)			
SIZE	CODE	DOC. NUMBER	REV
A3	CS	I310A20305	A02

CHANGE by	Drawer Name	20-Apr-2006	SHEET	13	OF	69
-----------	-------------	-------------	-------	----	----	----

**BLANK**

**INVENTEC**

TITLE			
TAOS20			
BLANK			
SIZE	CODE	DOC. NUMBER	REV
A3	CS	1310A20305	A02

CHANGE by *Drawer Name* 20-Apr-2006

SHEET 14 OF 69

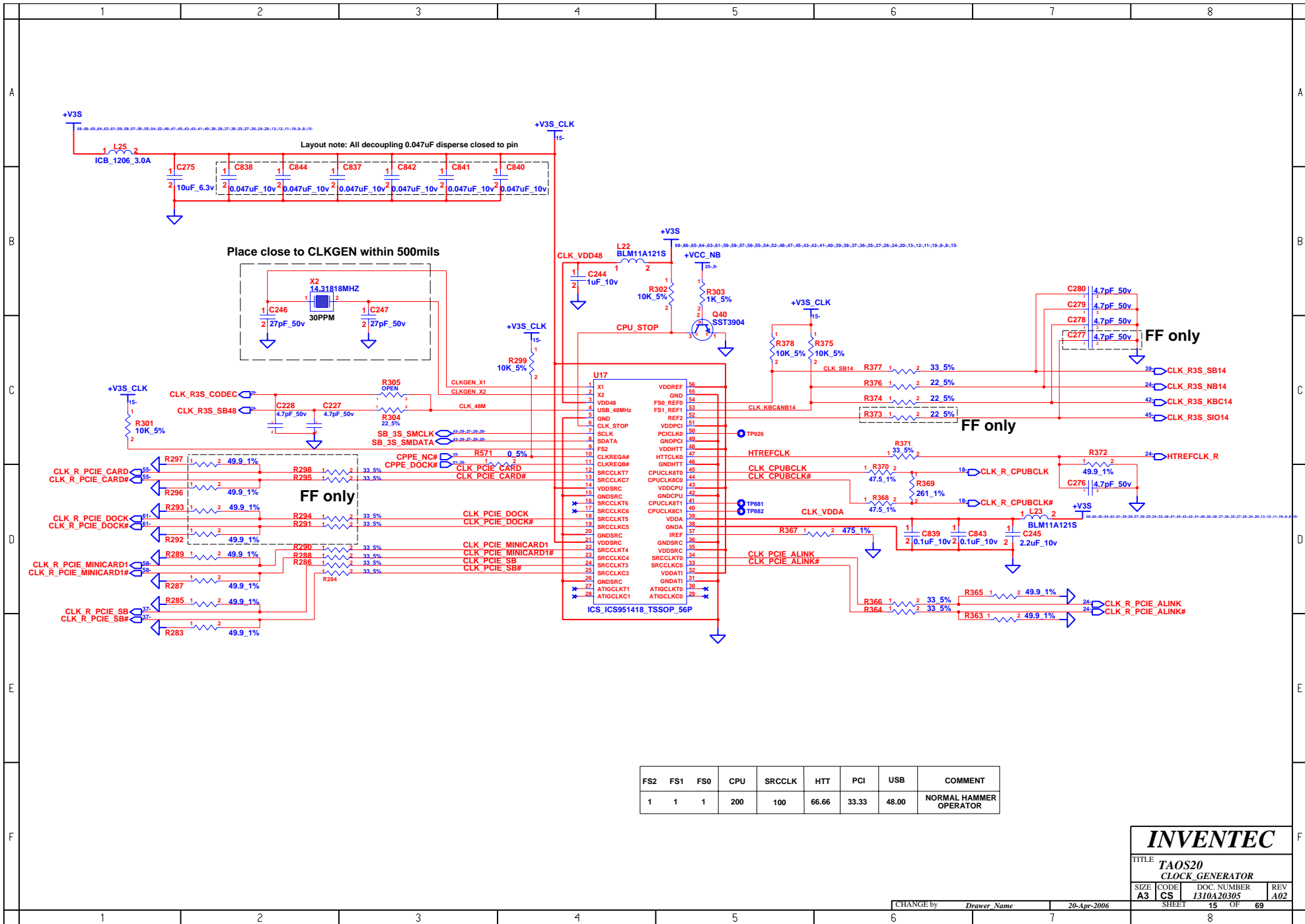

**INVENTEC**

TITLE  
TAOS20  
CLOCK\_GENERATOR

SIZE A3	CODE CS	DOC. NUMBER I310A20305	REV A02
------------	------------	---------------------------	------------

CHANGE by *Drawer Name* 20-Apr-2006 SHEET 15 OF 69

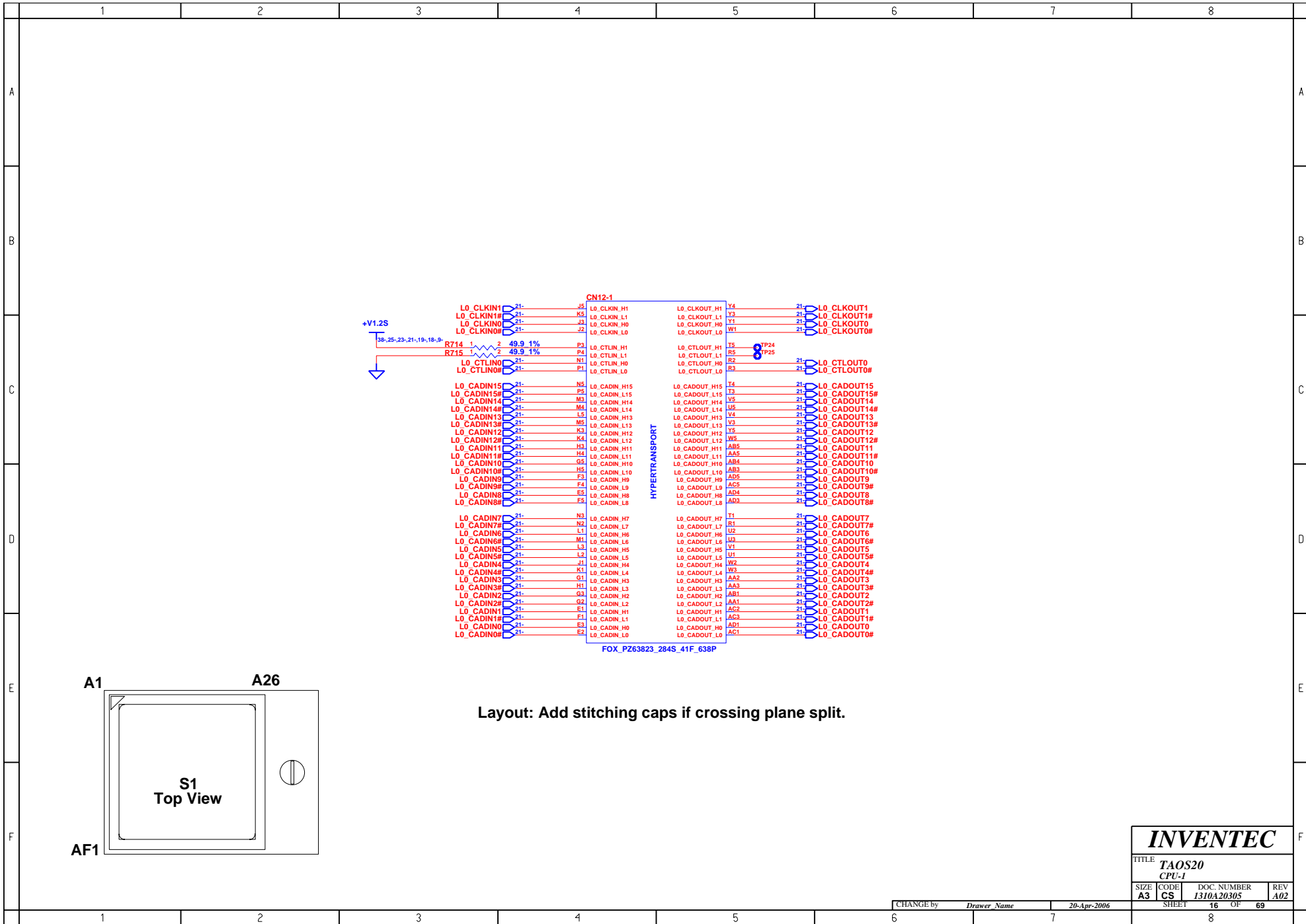

Layout: Add stitching caps if crossing plane split.

**INVENTEC**

TITLE			
TAOS20			
CPU-1			
SIZE	CODE	DOC. NUMBER	REV
A3	CS	1310A20305	A02
CHANGE by		Drawer Name	20-Apr-2006
SHEET		16	OF 69



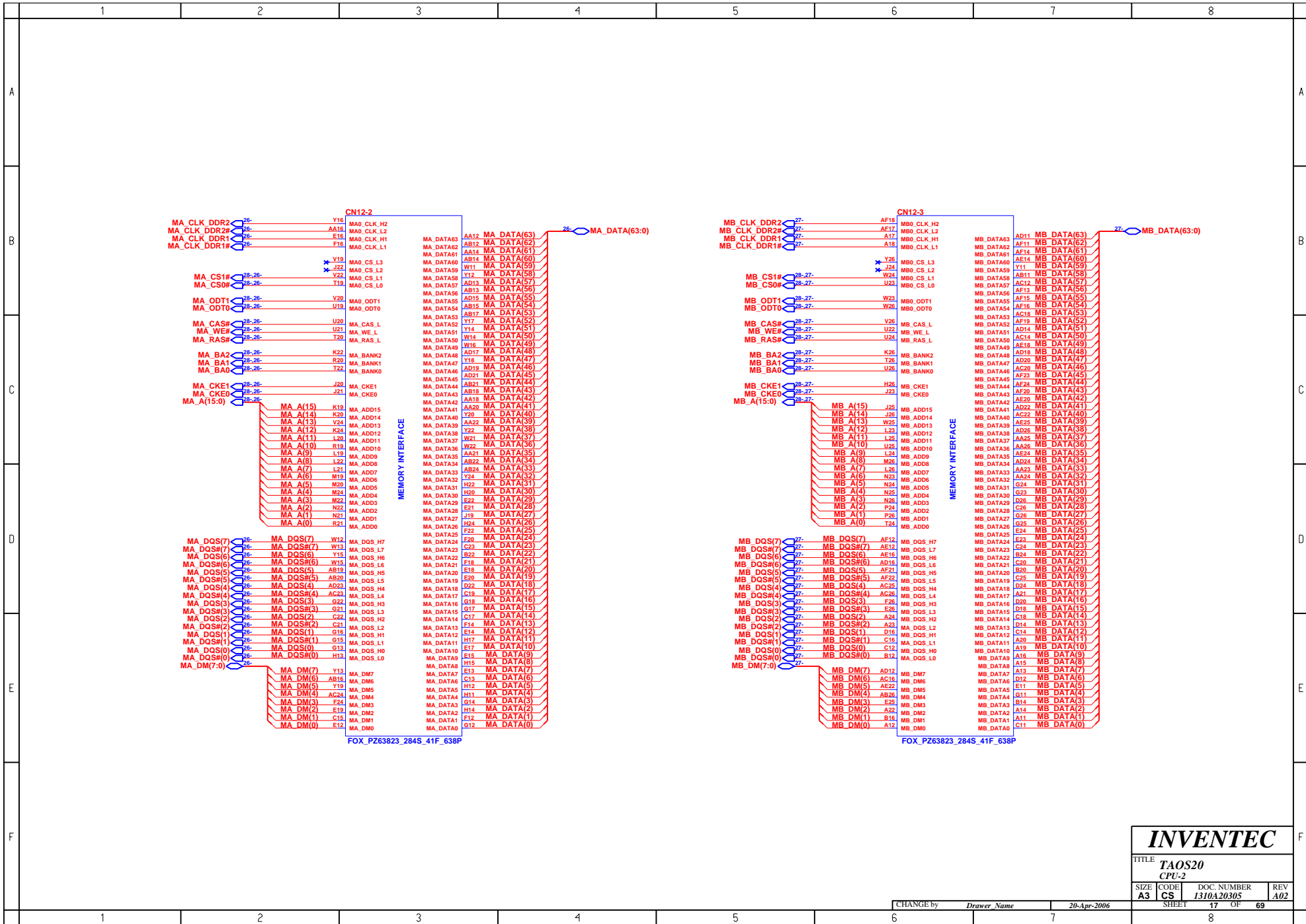

<b>INVENTEC</b>			
TITLE TAOS20 CPU-2			
SIZE A3	CODE CS	DOC. NUMBER 1310A20305	REV A02
CHANGE by Drawer Name		20-Apr-2006	SHEET 17 OF 69

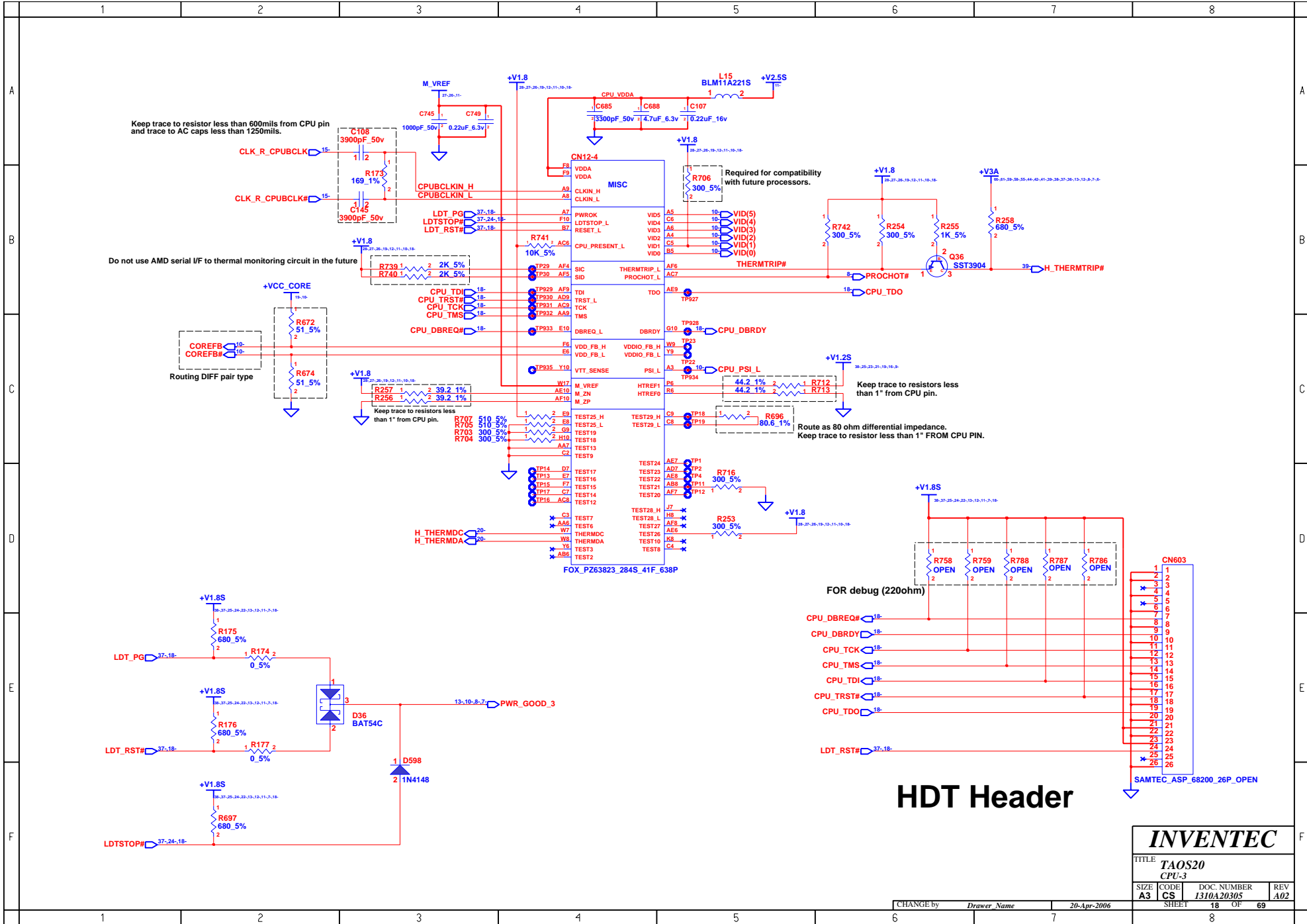

Keep trace to resistor less than 600mils from CPU pin and trace to AC caps less than 1250mils.

Do not use AMD serial I/F to thermal monitoring circuit in the future

Routing DIFF pair type

Required for compatibility with future processors.

Keep trace to resistors less than 1" from CPU pin.

Route as 80 ohm differential impedance. Keep trace to resistor less than 1" FROM CPU PIN.

FOR debug (220ohm)

# HDT Header

**INVENTEC**

TITLE  
TAOS20  
CPU-3

SIZE A3	CODE CS	DOC. NUMBER I310A20305	REV A02
------------	------------	---------------------------	------------

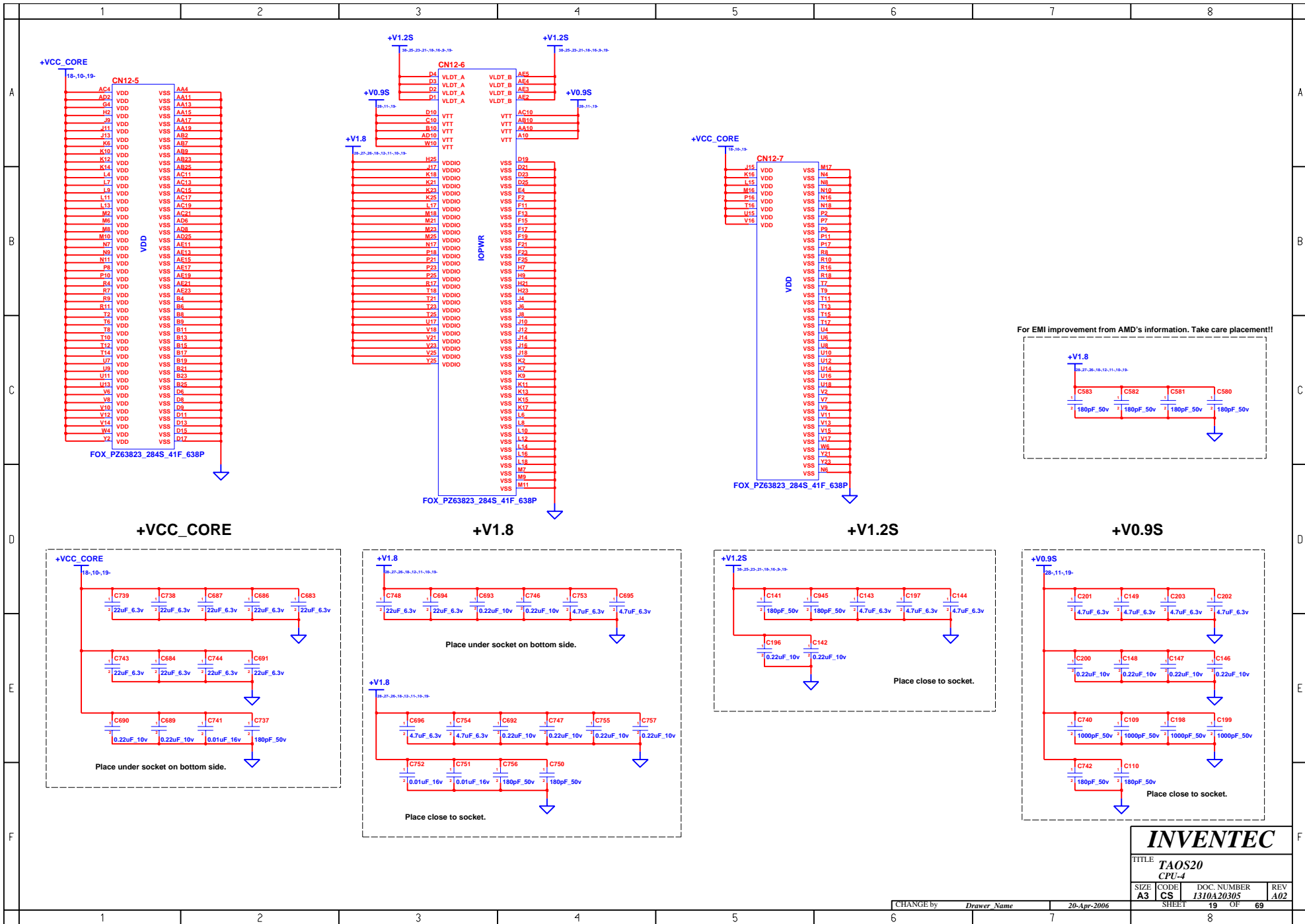

# INVENTEC

TITLE TAOS20 CPU-4			
SIZE A3	CODE CS	DOC. NUMBER I310A20305	REV A02
CHANGE by Drawer Name		20-Apr-2006	
SHEET 19		OF 69	

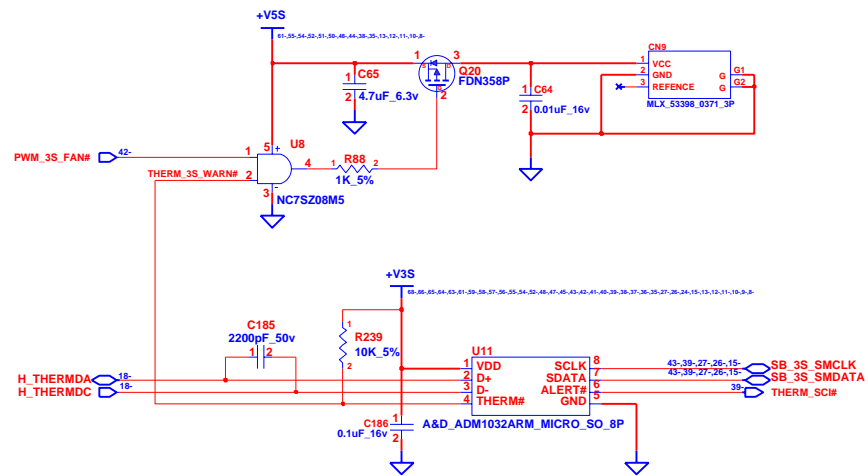

**LAYOUT Note: Put the thermal sensor close to CPU.**

<b>INVENTEC</b>			
TITLE <b>TAOS20 THERMAL&amp;FAN CONTROLLER</b>			
SIZE <b>A3</b>	CODE <b>CS</b>	DOC. NUMBER <b>1310A20305</b>	REV <b>A01</b>
CHANGE by <i>Drawer Name</i>		20-Apr-2006	SHEET 20 OF 69

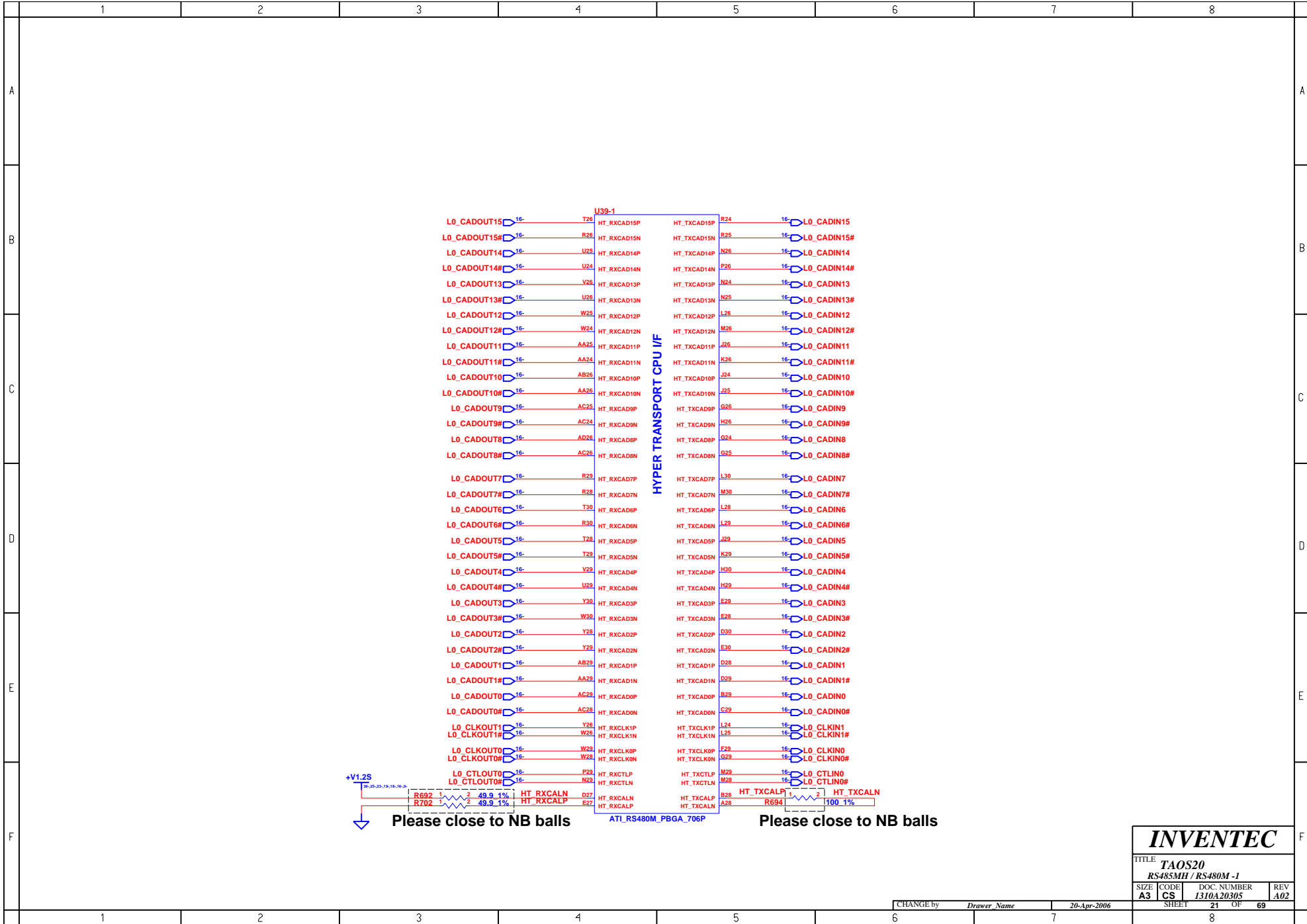

+V1.2S

Please close to NB balls

ATI\_RS480M\_PBGA\_706P

Please close to NB balls

**INVENTEC**

TITLE			
TAOS20			
RS485MH / RS480M -1			
SIZE	CODE	DOC. NUMBER	REV
A3	CS	I310A20305	A02

CHANGE by *Drawer Name* 20-Apr-2006

SHEET 21 OF 69

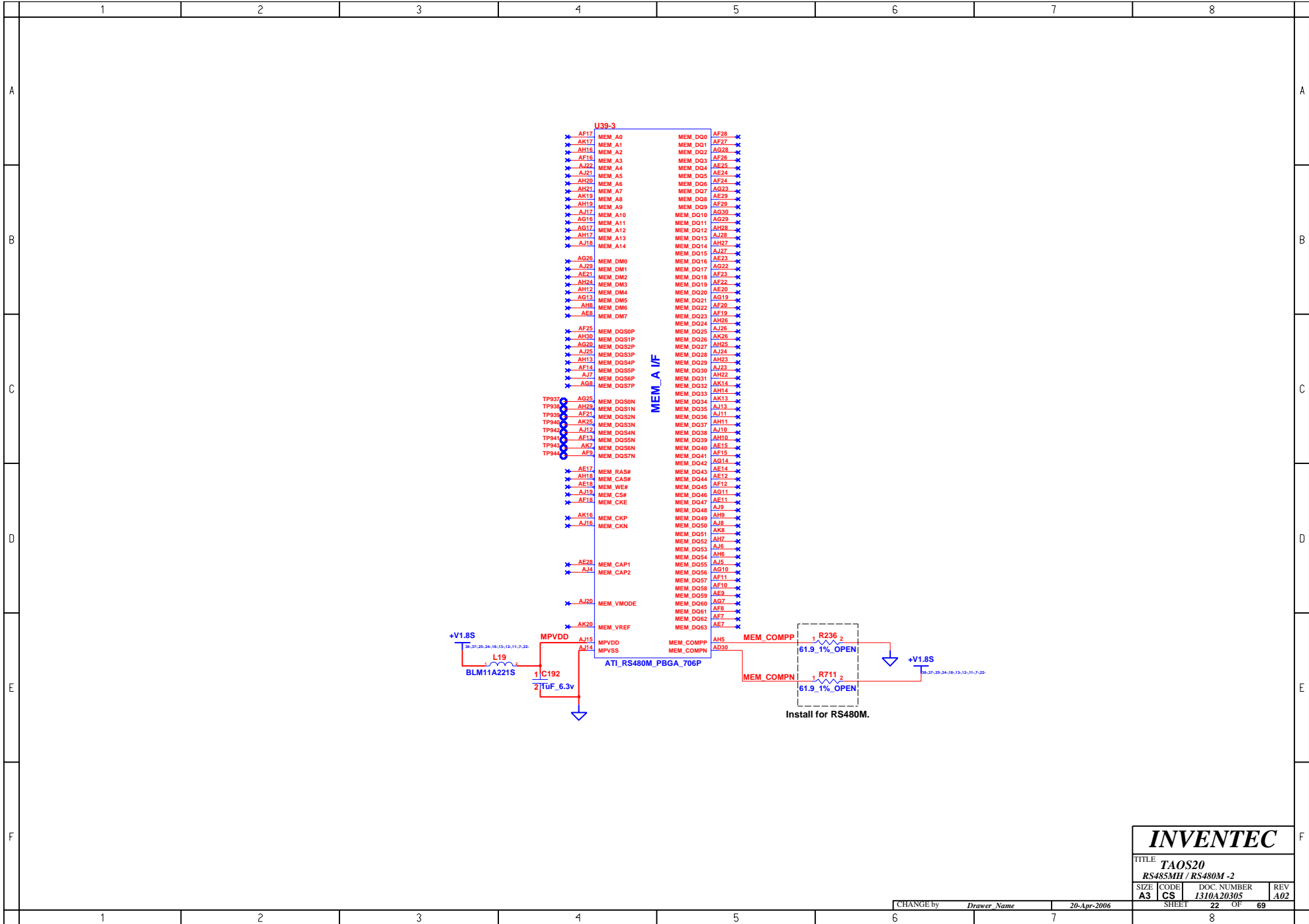

<b>INVENTEC</b>			
TITLE TAOS20			
RS485MH / RS480M -2			
SIZE	CODE	DOC. NUMBER	REV
A3	CS	1310A20305	A02

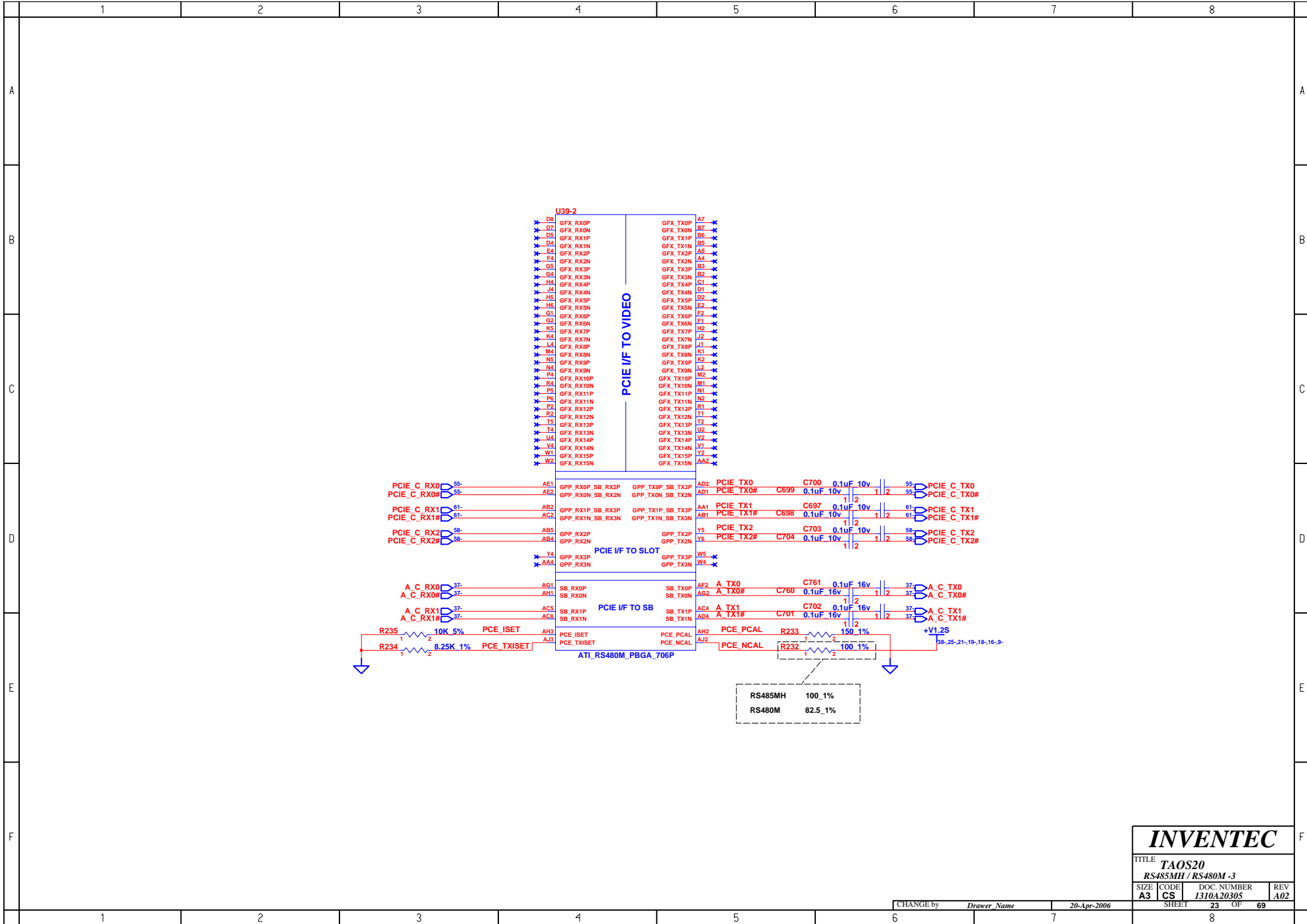

<b>INVENTEC</b>			
TITLE TAOS20			
RS485MH / RS480M -3			
SIZE	CODE	DOC. NUMBER	REV
A3	CS	1310A20305	A02
CHANGE by		Drawer Name	20-Apr-2006
SHEET		23	OF 69

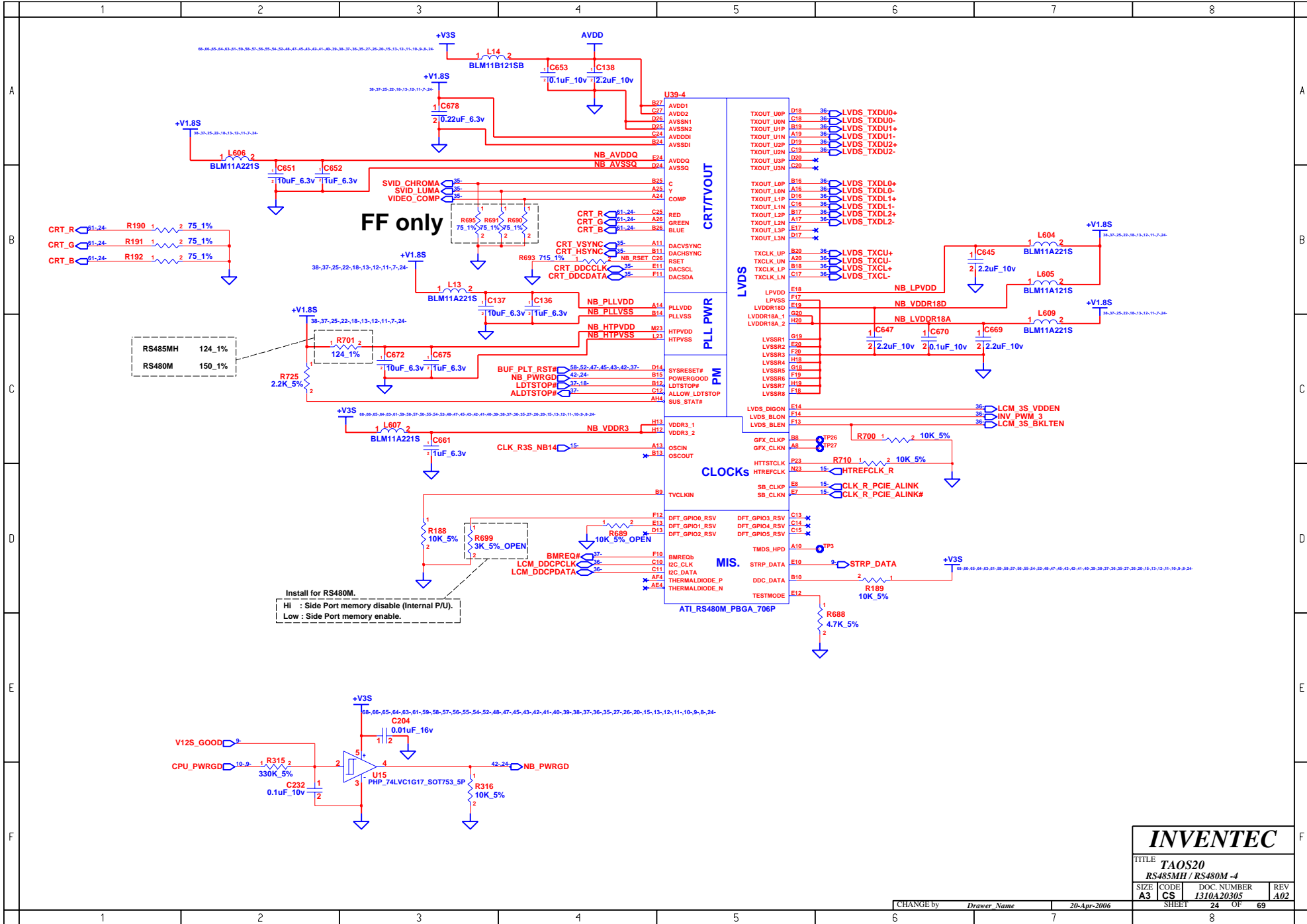

<b>INVENTEC</b>			
TITLE TAOS20			
RS485MH / RS480M -4			
SIZE	CODE	DOC. NUMBER	REV
A3	CS	1310A20305	A02
CHANGE by		Drawer Name	20-Apr-2006
SHEET		24	OF 69



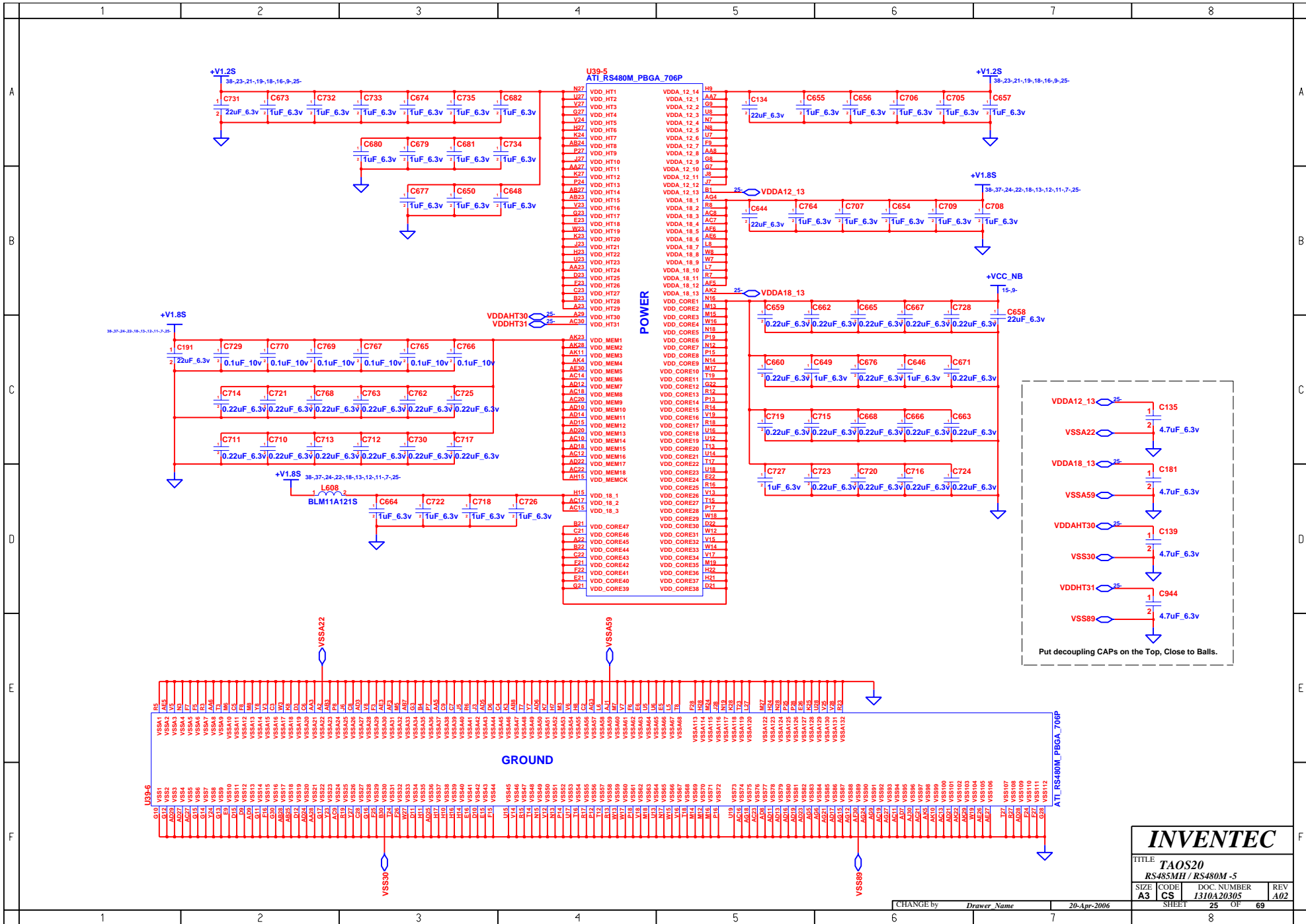

# INVENTEC

TITLE  
**TAOS20**  
 RS485MH / RS480M -5

SIZE	CODE	DOC. NUMBER	REV
A3	CS	1310A20305	A02

CHANGE by *Drawer Name* 20-Apr-2006

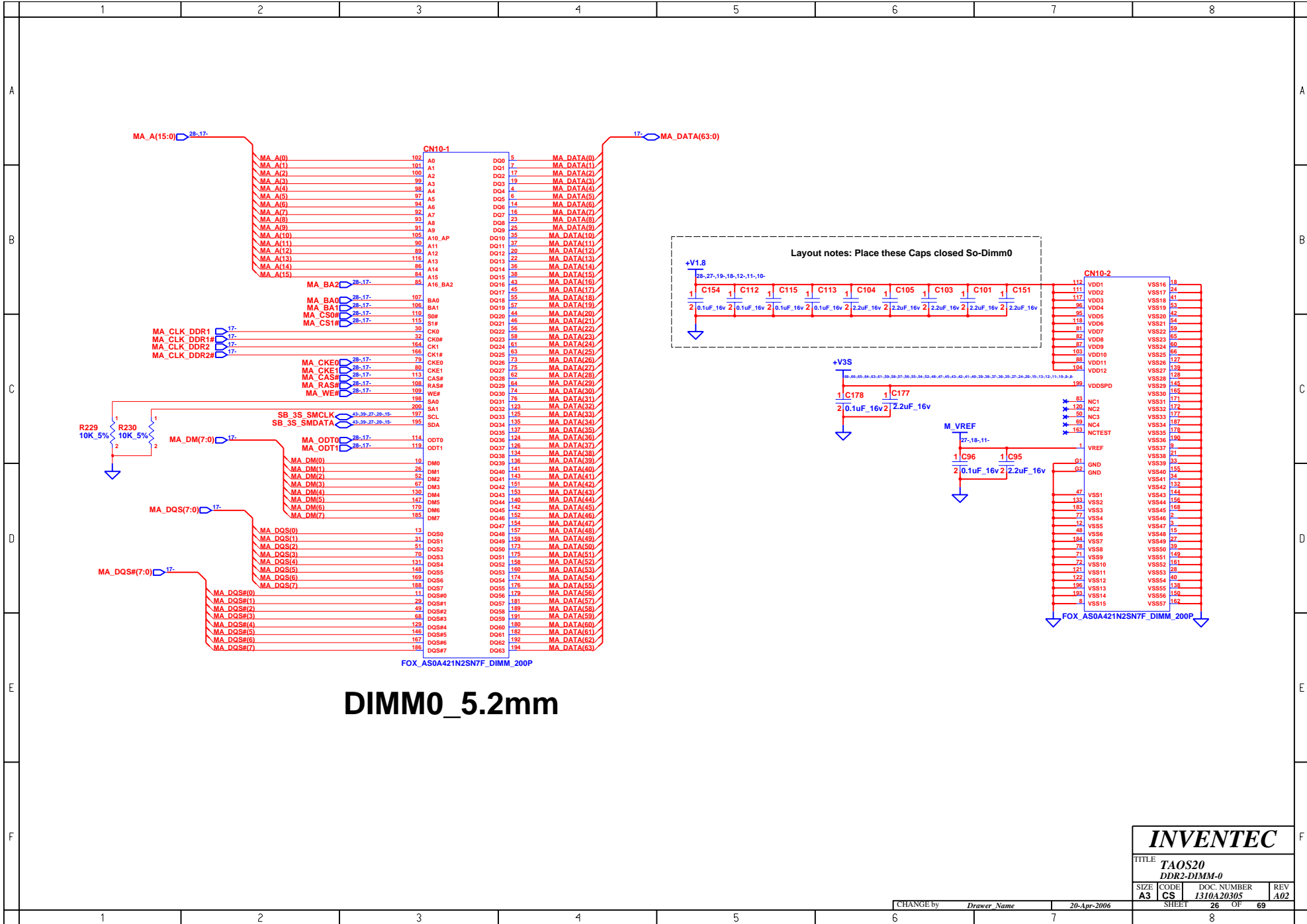

**INVENTEC**

TITLE TAOS20  
DDR2-DIMM-0

SIZE A3	CODE CS	DOC. NUMBER 1310A20305	REV A02
---------	---------	------------------------	---------

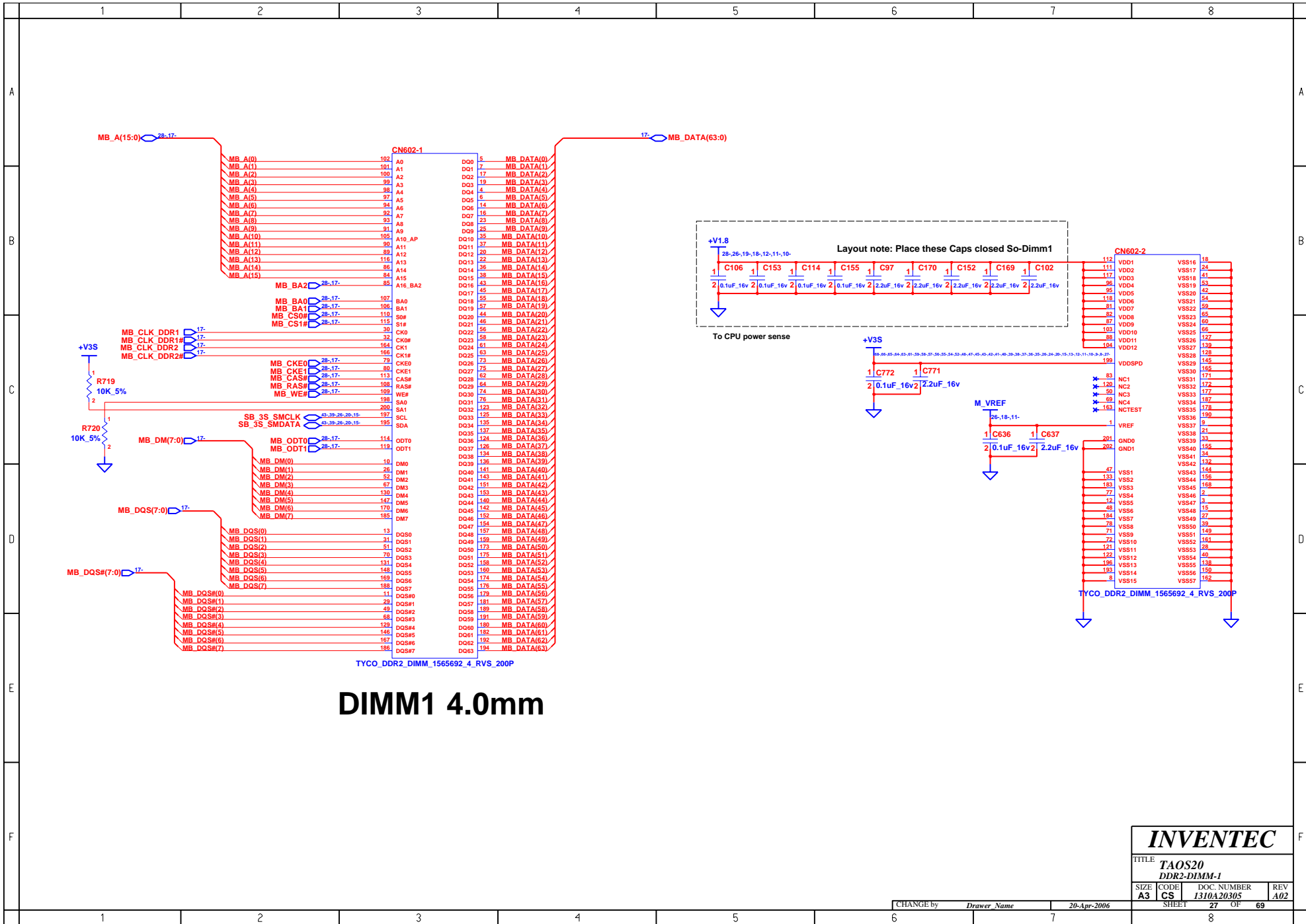

<b>INVENTEC</b>			
TITLE TAOS20 DDR2-DIMM-1			
SIZE A3	CODE CS	DOC. NUMBER 1310A20305	REV A02
CHANGE by Drawer Name		20-Apr-2006	
SHEET 27		OF 69	

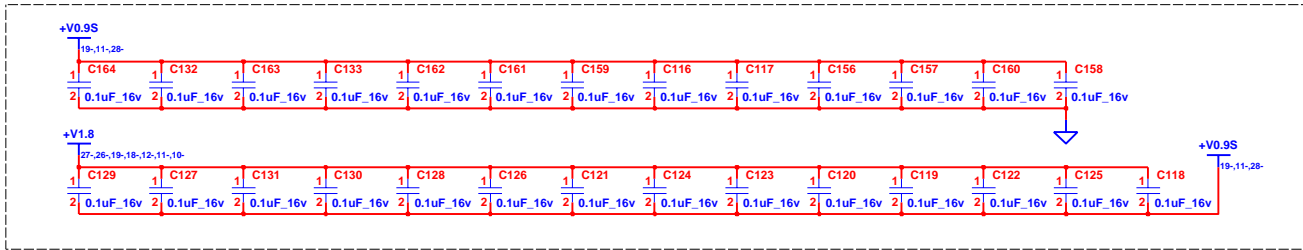

To CPU power sense

### Place CAPs close to DIMM

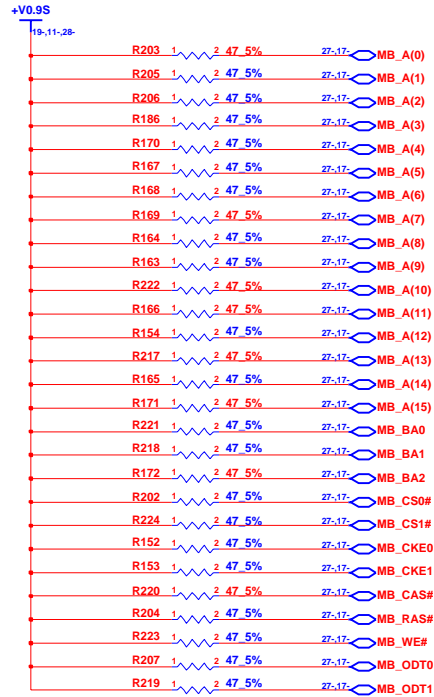
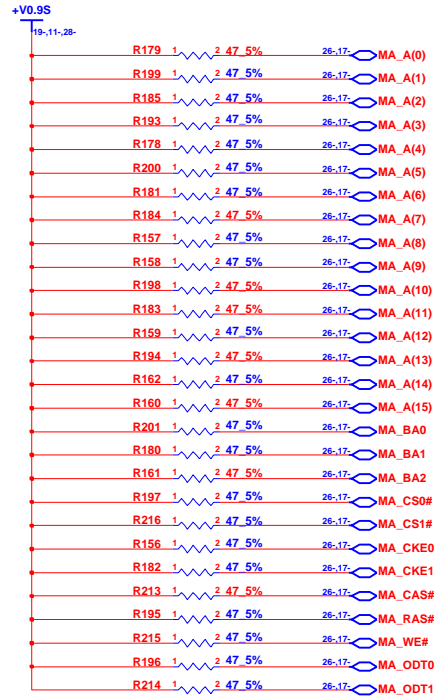

## INVENTEC

TITLE			
TAOS20			
DDR2-DAMPING			
SIZE	CODE	DOC. NUMBER	REV
A3	CS	I310A20305	A02
CHANGE by		SHEET	
Drawer Name		28 OF 69	

20-Apr-2006

# BLANK

<b>INVENTEC</b>			
TITLE <b>TAOS20</b>			
BLANK			
SIZE <b>A3</b>	CODE <b>CS</b>	DOC. NUMBER <b>I310A20305</b>	REV <b>A02</b>
CHANGE by <i>Drawer Name</i>		20-Apr-2006	
SHEET <b>29</b>		OF <b>69</b>	

**BLANK**

**INVENTEC**

TITLE			
TAOS20			
BLANK			
SIZE	CODE	DOC. NUMBER	REV
A3	CS	1310A20305	A02

CHANGE by *Drawer Name* 20-Apr-2006

SHEET 30 OF 69

**BLANK**

**INVENTEC**

TITLE			
TAOS20			
BLANK			
SIZE	CODE	DOC. NUMBER	REV
A3	CS	1310A20305	A02

CHANGE by *Drawer Name* 20-Apr-2006

SHEET 31 OF 69

	1	2	3	4	5	6	7	8	
A									A
B									B
C									C
D									D
E									E
F									F
	1	2	3	4	5	6	7	8	

**BLANK**

**INVENTEC**

TITLE			
<b>TAOS20</b>			
<b>BLANK</b>			
SIZE	CODE	DOC. NUMBER	REV
<b>A3</b>	<b>CS</b>	<b>1310A20305</b>	<b>A02</b>
SHEET		32	OF 69

CHANGE by *Drawer Name* 27-Sep-2003

	1	2	3	4	5	6	7	8	
A									A
B									B
C									C
D									D
E									E
F									F
	1	2	3	4	5	6	7	8	



**BLANK**

**INVENTEC**

TITLE			
TAOS20			
BLANK			
SIZE	CODE	DOC. NUMBER	REV
A3	CS	1310A20305	A02
SHEET		33	OF 69

CHANGE by *Drawer Name* 20-Apr-2006

SHEET 33 OF 69

	1	2	3	4	5	6	7	8	
A									A
B									B
C									C
D									D
E									E
F									F
	1	2	3	4	5	6	7	8	

**BLANK**

**INVENTEC**

TITLE			
TAOS20			
BLANK			
SIZE	CODE	DOC. NUMBER	REV
A3	CS	1310A20305	A02

CHANGE by *Drawer Name* 20-Apr-2006

SHEET 34 OF 69

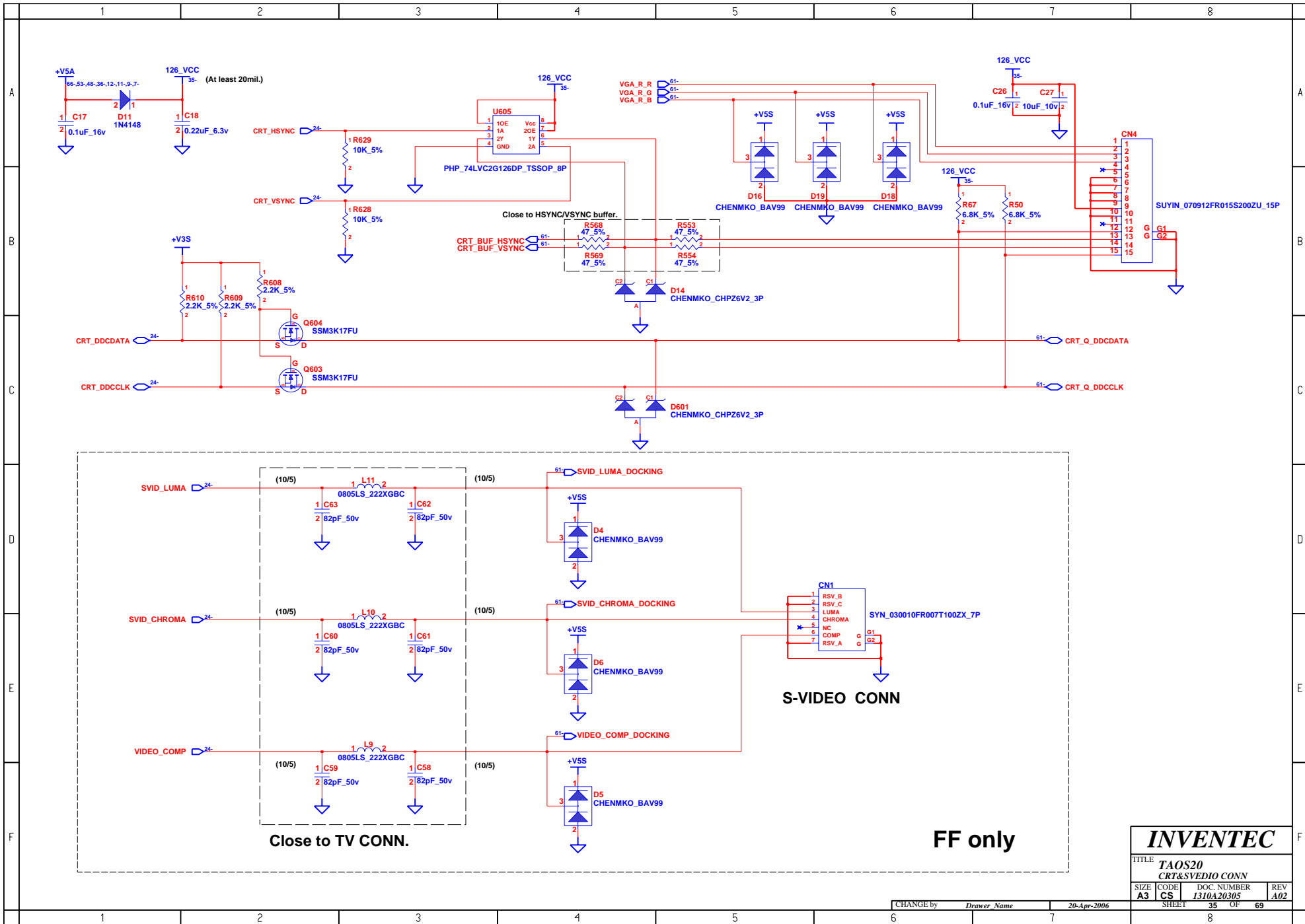

**INVENTEC**

TITLE			
TAOS20			
CRT&SVIDEO CONN			
SIZE	CODE	DOC. NUMBER	REV
A3	CS	1310A20305	A02

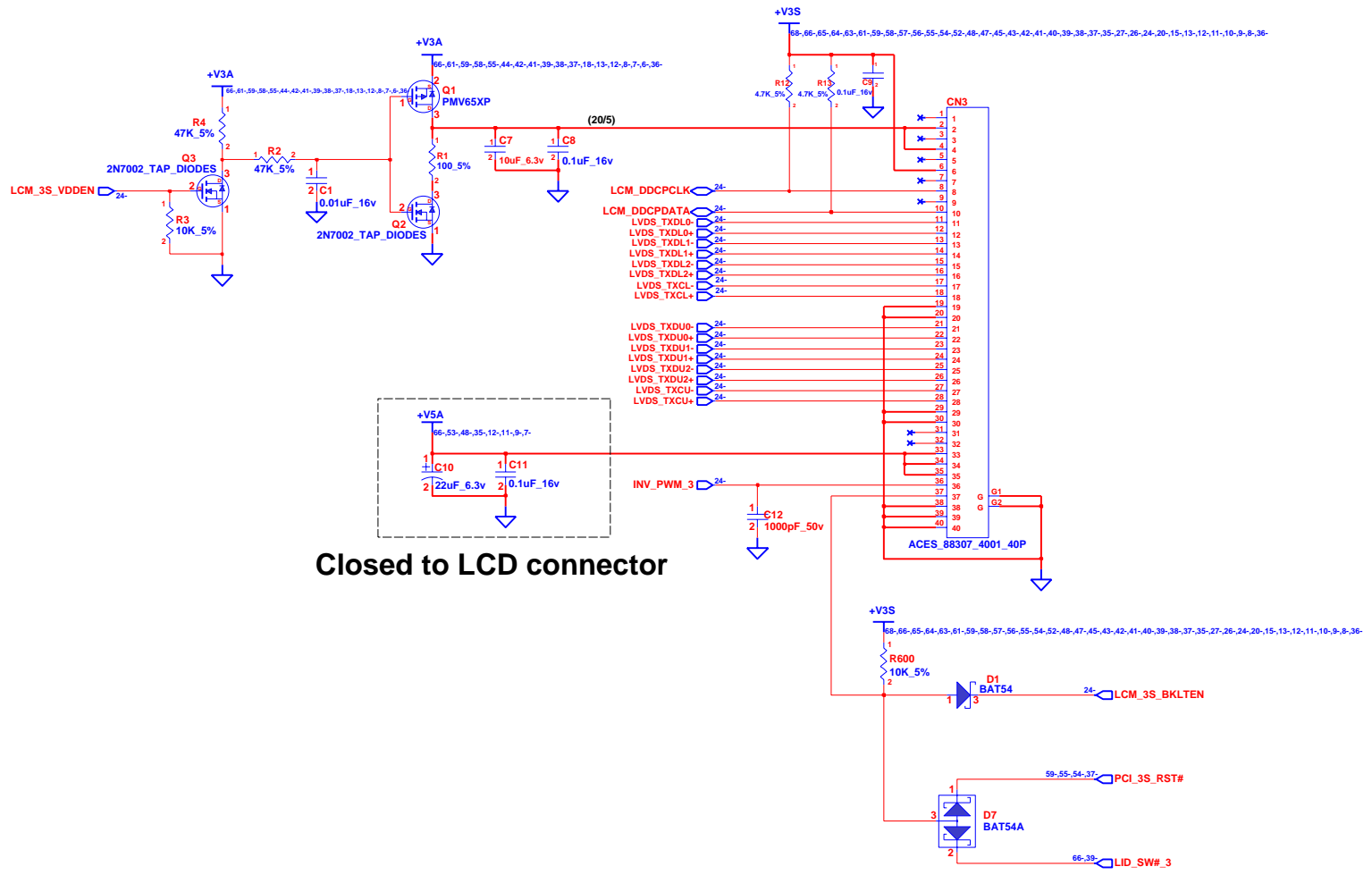

Closed to LCD connector

# INVENTEC

TITLE  
**TAOS20**  
**LCD CONN**

SIZE <b>A3</b>	CODE <b>CS</b>	DOC. NUMBER <b>I310A20305</b>	REV <b>A02</b>
-------------------	-------------------	----------------------------------	-------------------

CHANGE by *Drawer Name* 20-Apr-2006 SHEET 36 OF 69

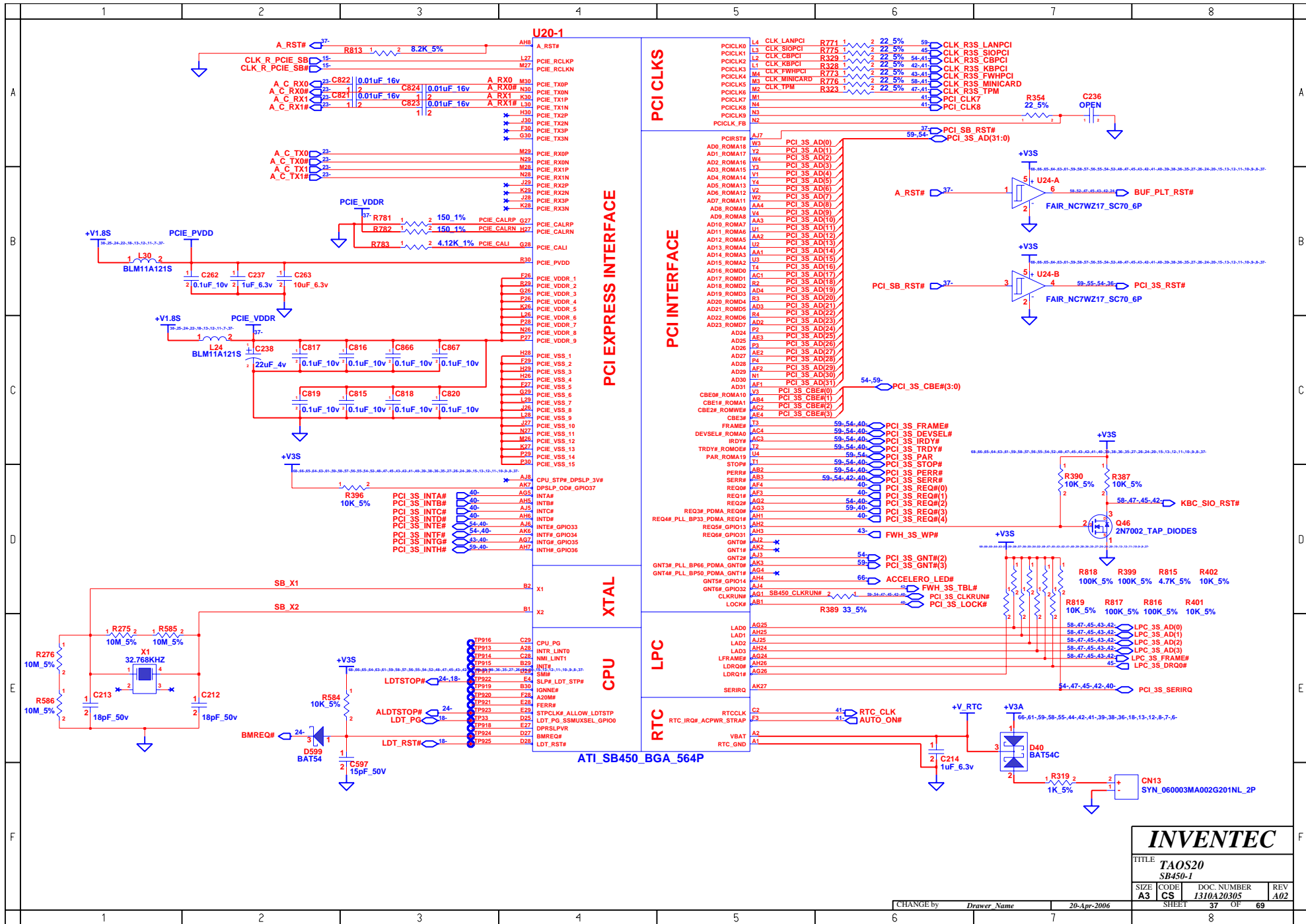

# INVENTEC

TITLE TAOS20 SB450-1			
SIZE A3	CODE CS	DOC. NUMBER 1310A20305	REV A02

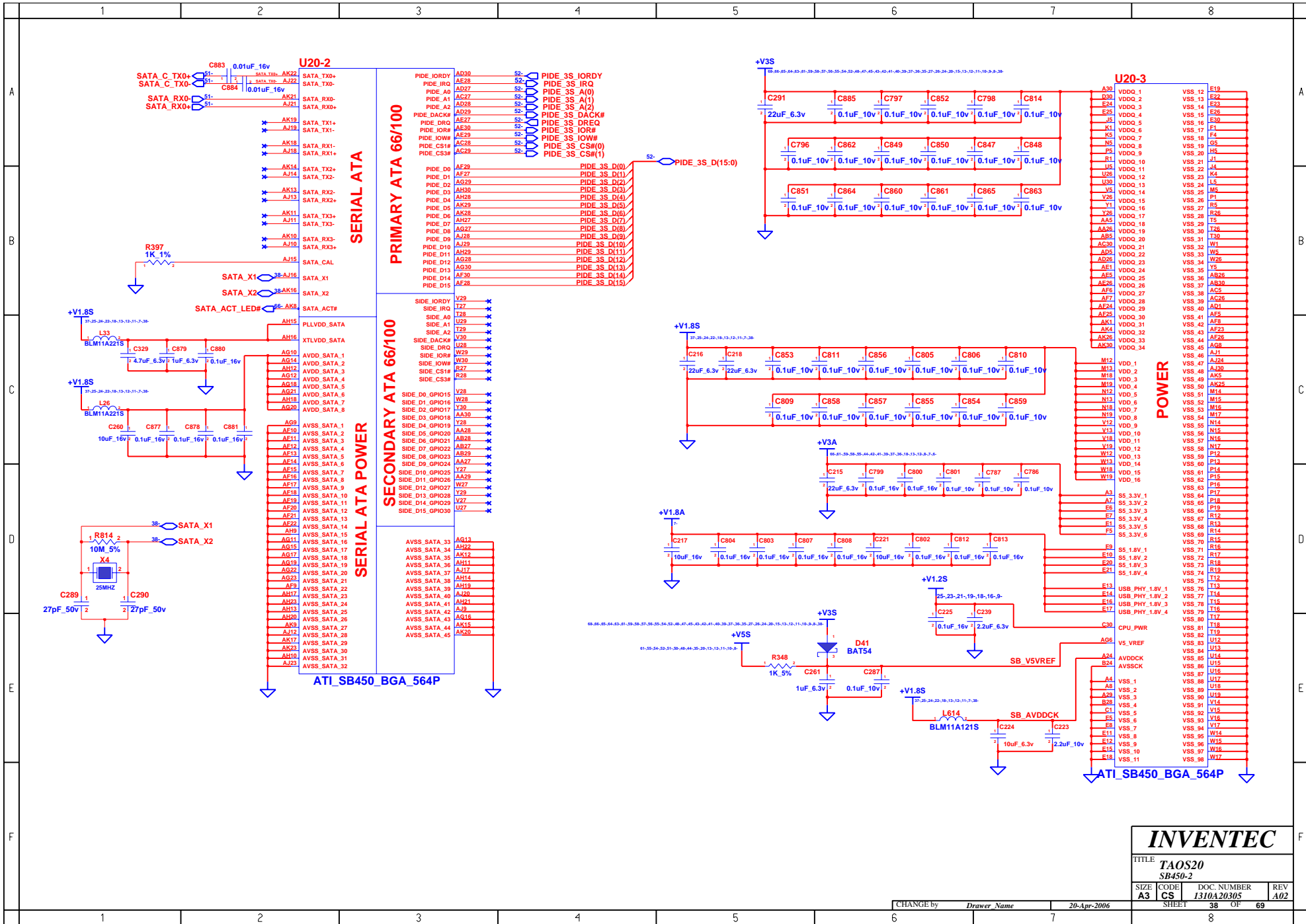

<b>INVENTEC</b>			
TITLE <b>TAOS20 SB450-2</b>			
SIZE <b>A3</b>	CODE <b>CS</b>	DOC. NUMBER <b>I310A20305</b>	REV <b>A02</b>
CHANGE by <i>Drawer Name</i>		20-Apr-2006	
SHEET <b>38</b>		OF <b>69</b>	

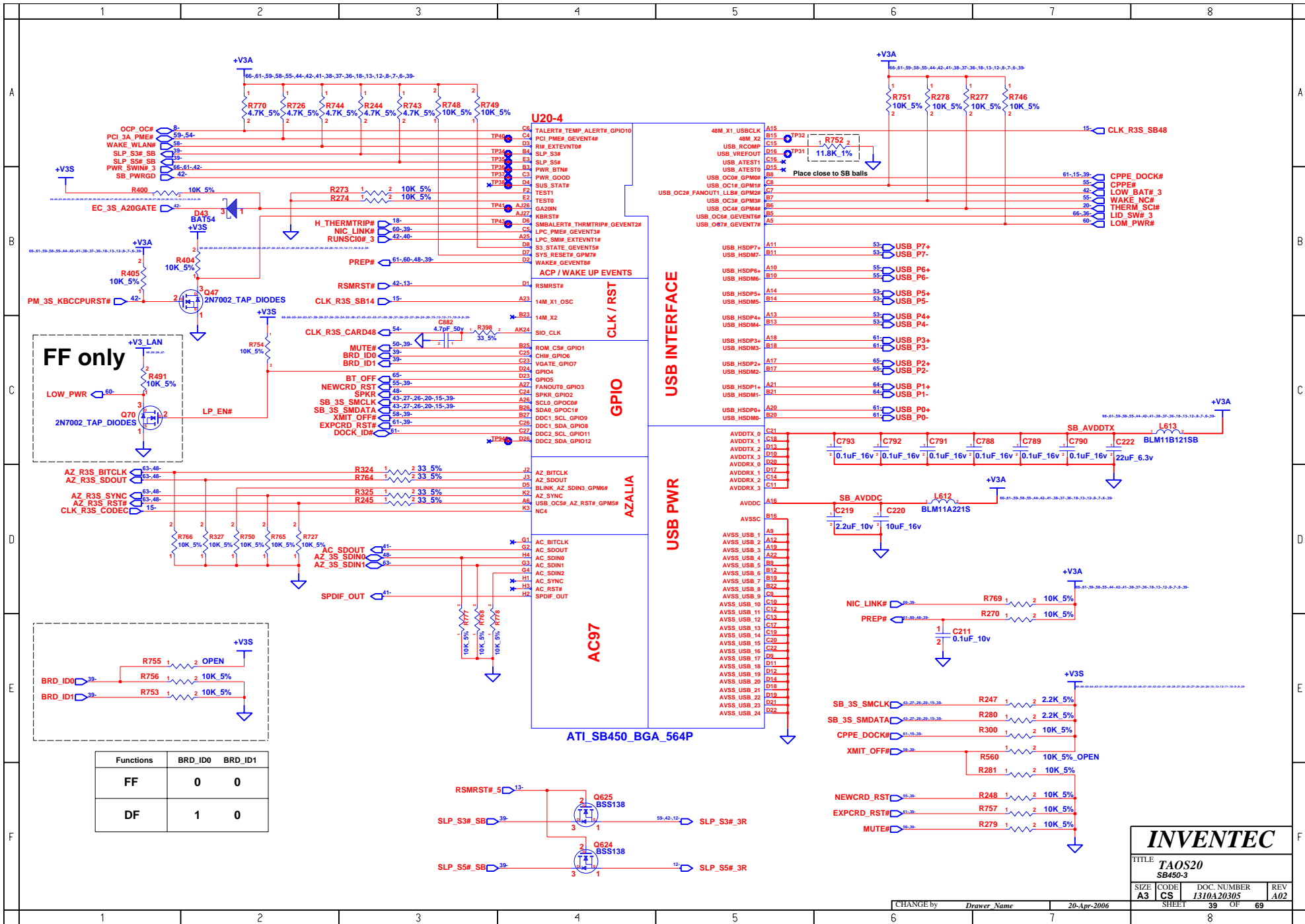

**INVENTEC**

TITLE TAOS20  
SB450-3

SIZE A3	CODE CS	DOC. NUMBER 1310A20305	REV A02
---------	---------	------------------------	---------

CHANGE by *Drawer Name* 20-Apr-2006 SHEET 39 OF 69

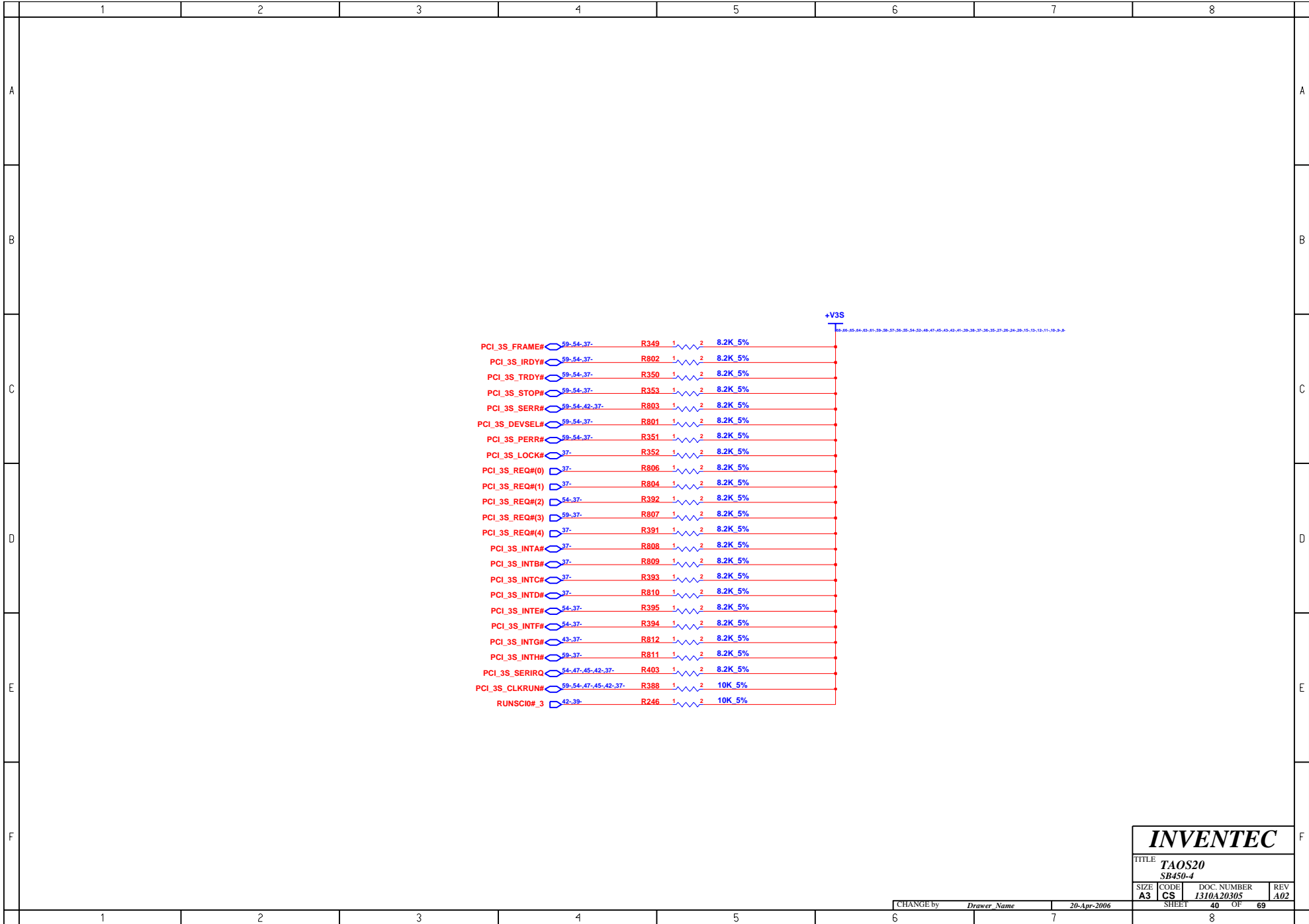

**INVENTEC**

TITLE TAOS20  
SB450-4

SIZE A3	CODE CS	DOC. NUMBER 1310A20305	REV A02
------------	------------	---------------------------	------------

CHANGE by *Drawer Name* 20-Apr-2006

SHEET 40 OF 69



**Required Straps:**

	ACPWRON	AC_SDOUT	RTC_CLK	SPDIF_OUT	CLK_R3S_CBPCI	CLK_R3S_KBPCI	CLK_R3S_FWHPCI	CLK_R3S_MINICARD	PCI_CLK6	PCI_CLK7 PCI_CLK8
<b>PULL HIGH</b>	MANUAL POWER ON ■	USE DEBUG STRAPS	INTERNAL RTC ■	SIO 24MHz	48MHz XTAL	PHY PWRDOWN DISABLE ■	USE INT. PLL48	PCIE CM_SET LOW ■	CPU K8 ■	HH: PCI ROM HL: LPC 1 ROM
<b>PULL LOW</b>	AUTO POWER ON	IGNORE DEBUG STRAPS ■	EXTERNAL RTC	SIO 48MHz ■	48MHz OSC ■	PHY PWRDOWN ENABLE	USE EXT. 48M CLK ■	PCIE CM_SET HIGH	CPU P4	LH: LPC 2 ROM ■ LL: FWH ROM

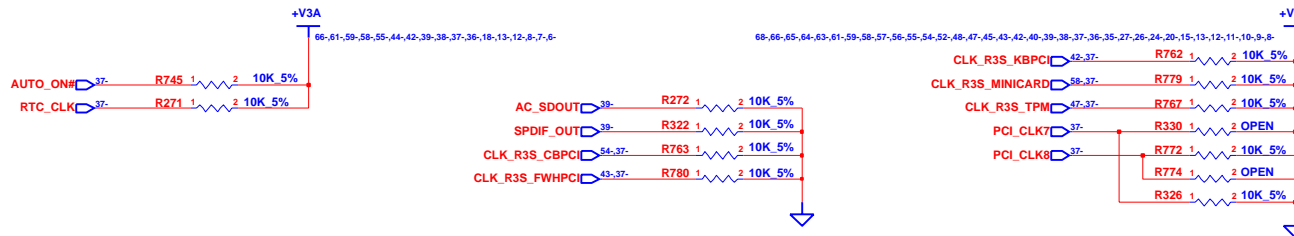

**INVENTEC**

TITLE TAOS20  
SB450-5

SIZE A3	CODE CS	DOC. NUMBER 1310A20305	REV A02
------------	------------	---------------------------	------------

CHANGE by *Drawer Name* 20-Apr-2006

SHEET 41 OF 69

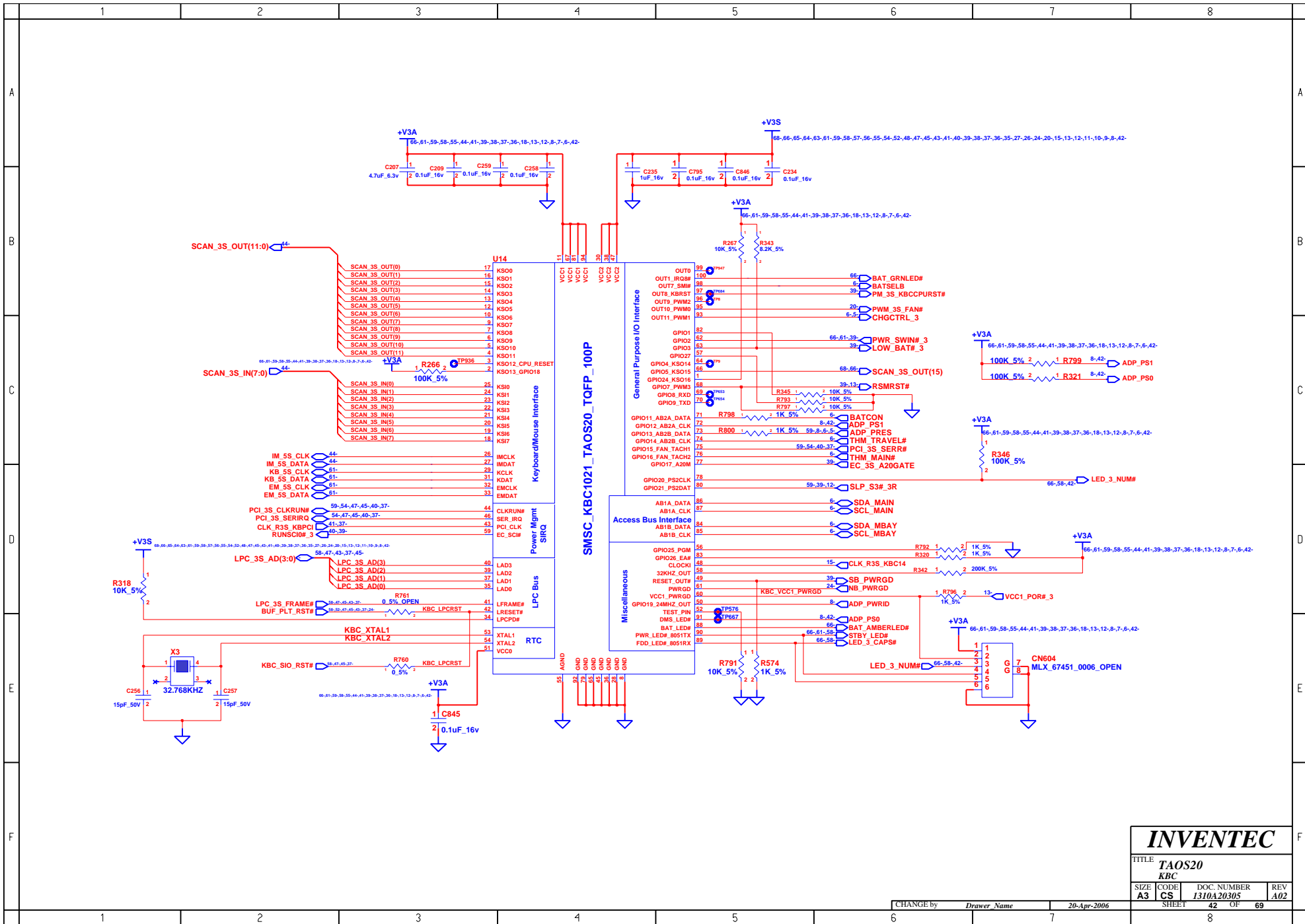

# INVENTEC

TITLE <b>TAOS20 KBC</b>			
SIZE <b>A3</b>	CODE <b>CS</b>	DOC. NUMBER <b>I310A20305</b>	REV <b>A02</b>

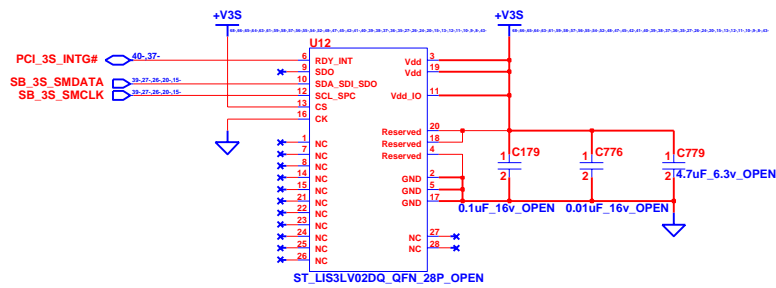
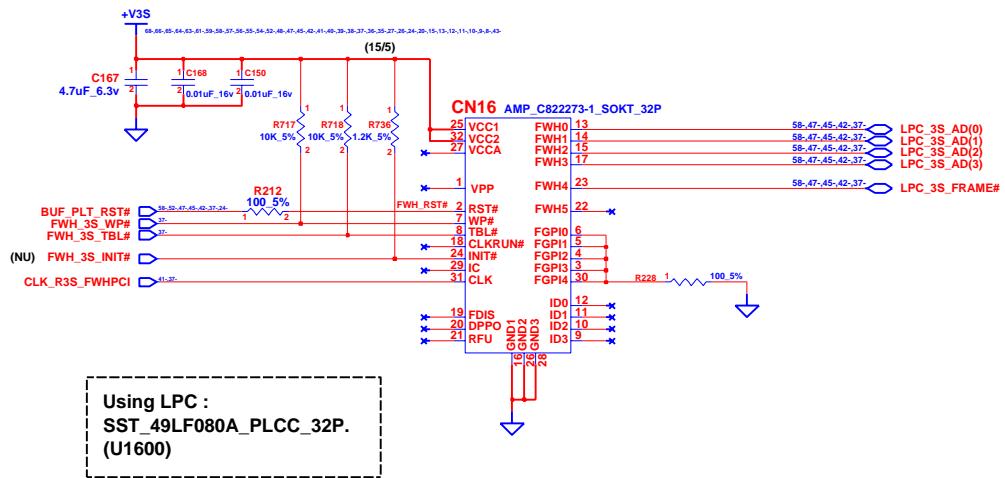

### Accelerometer (NI)

**INVENTEC**

TITLE			
TAOS20			
LPC & Accelerometer(NI)			
SIZE	CODE	DOC. NUMBER	REV
A3	CS	I310A20305	A02

CHANGE by *Drawer Name* 20-Apr-2006

SHEET 43 OF 69

# Keyboard CONN

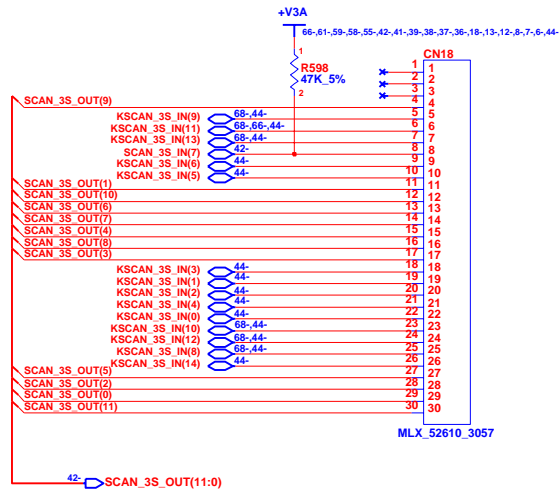

# Touch Pad CONN

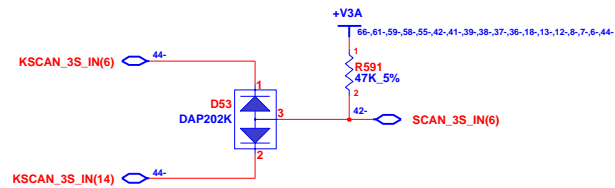
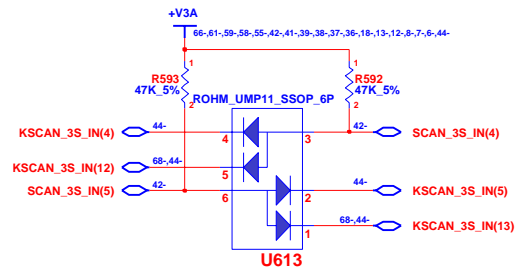
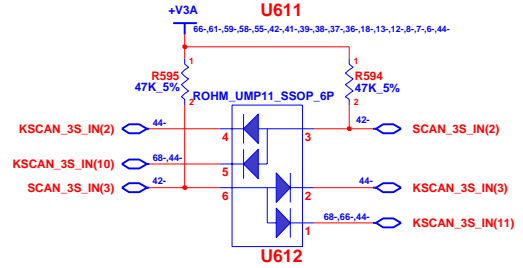
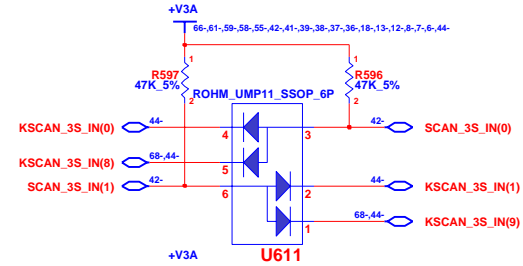
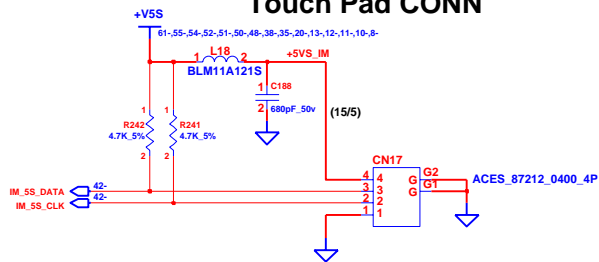

**INVENTEC**

TITLE TAOS20  
INT.KBC/POINT DEVICES

SIZE A3	CODE CS	DOC. NUMBER 1310A20305	REV A02
---------	---------	------------------------	---------

CHANGE by *Drawer Name* 20-Apr-2006

SHEET 44 OF 69

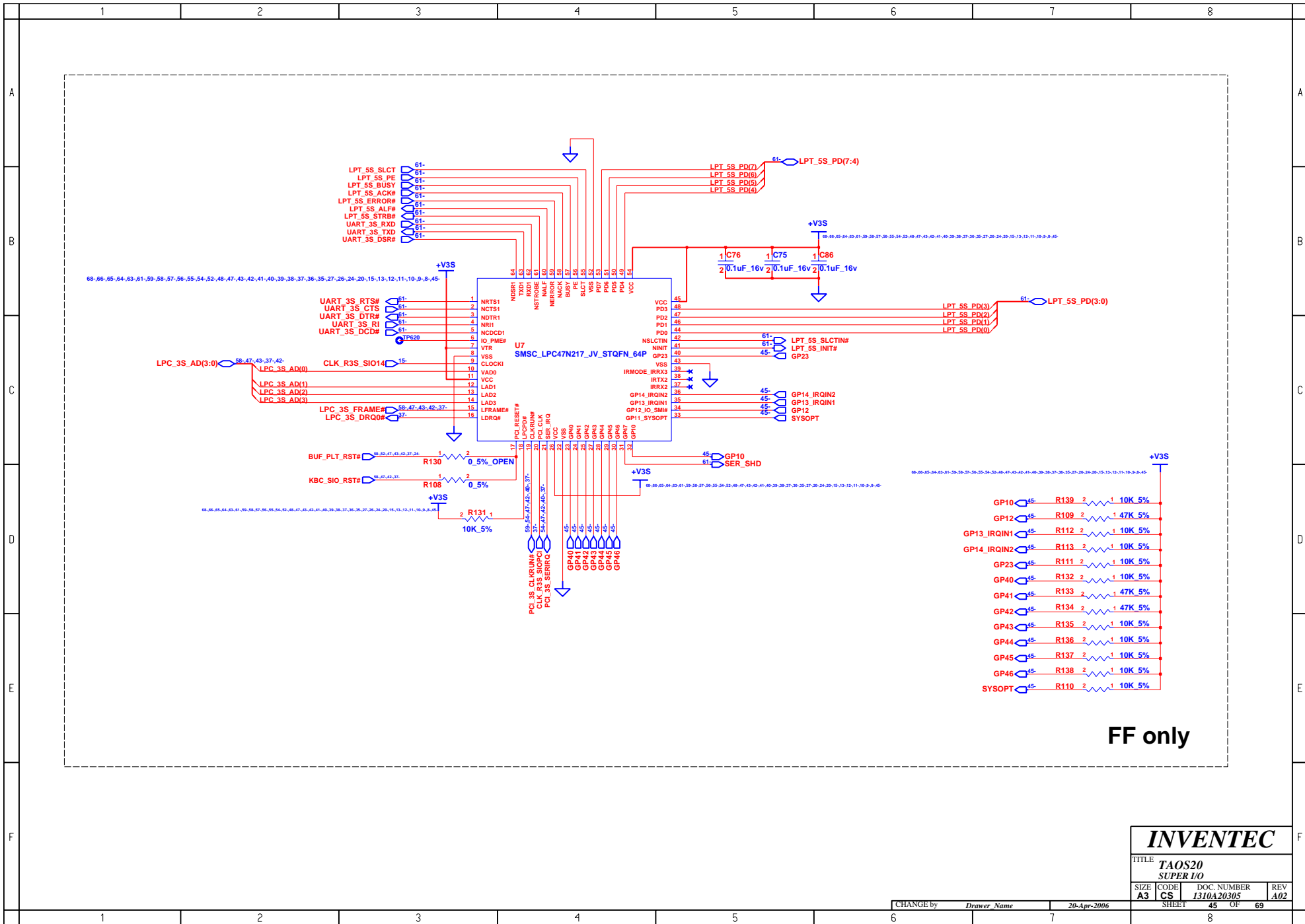

FF only

<b>INVENTEC</b>			
TITLE <b>TAOS20 SUPER I/O</b>			
SIZE <b>A3</b>	CODE <b>CS</b>	DOC. NUMBER <b>1310A20305</b>	REV <b>A02</b>
CHANGE by <i>Drawer Name</i>		20-Apr-2006	
SHEET		45 OF 69	

**BLANK**

**INVENTEC**

TITLE <i>TAOS20</i>			
Blank			
SIZE	CODE	DOC. NUMBER	REV
A3	CS	1310A20305	A02

CHANGE by *Drawer Name* 20-Apr-2006

SHEET 46 OF 69

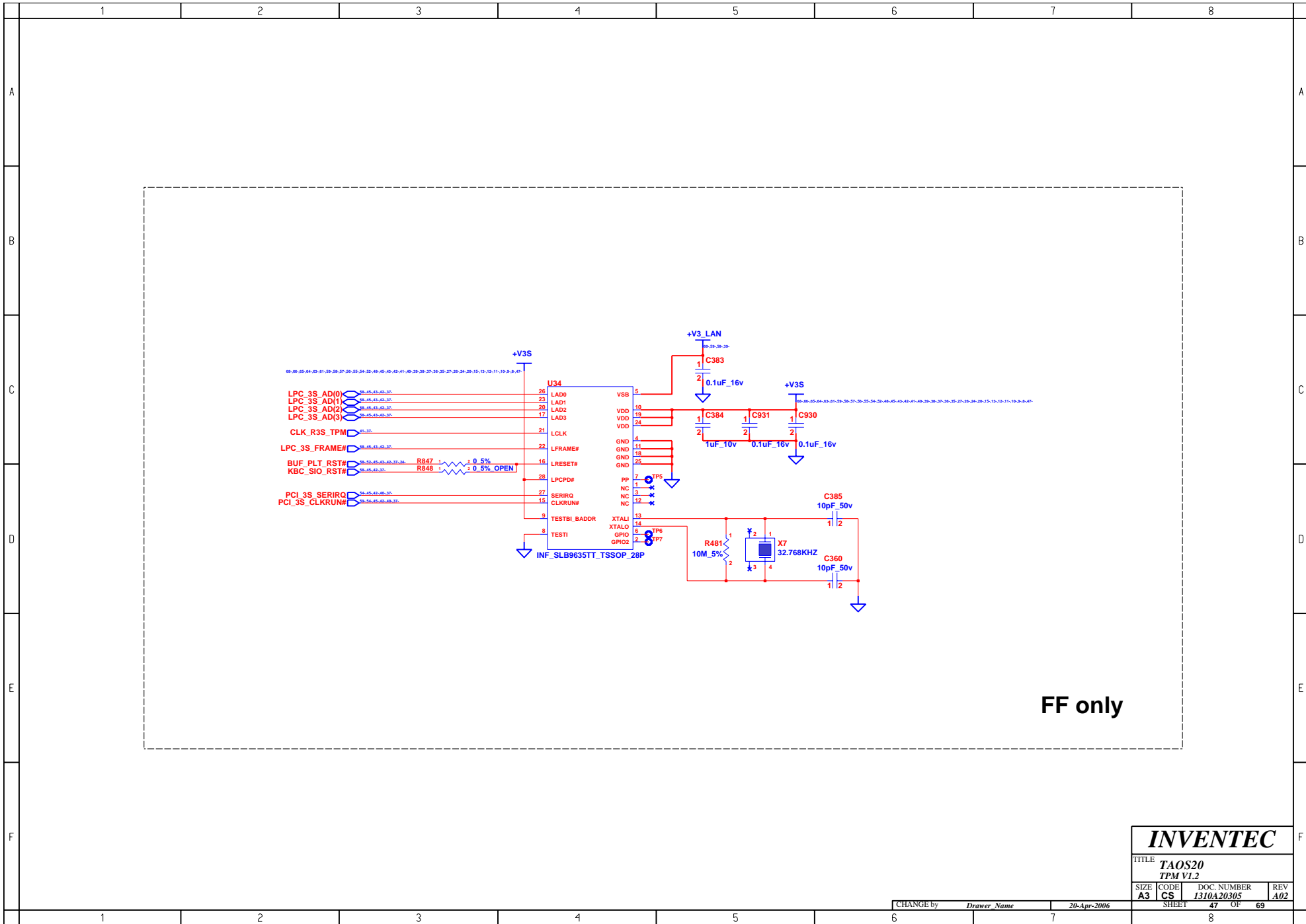

FF only

**INVENTEC**

TITLE			
TAOS20			
TPM V1.2			
SIZE	CODE	DOC. NUMBER	REV
A3	CS	I310A20305	A02

CHANGE by	Drawer Name	20-Apr-2006	SHEET	47	OF	69
-----------	-------------	-------------	-------	----	----	----

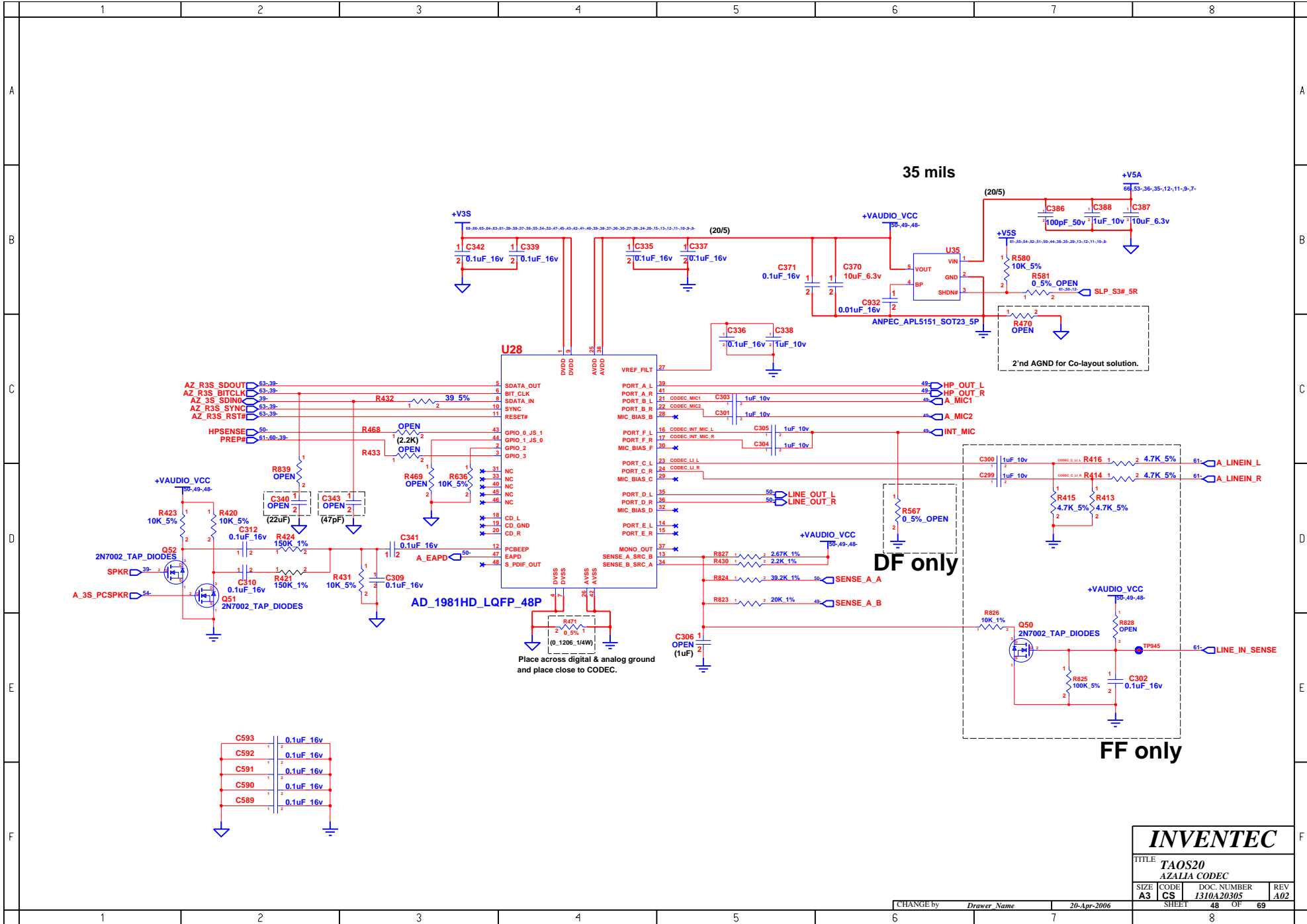

# INVENTEC

TITLE  
**TAOS20**  
 AZALIA CODEC

SIZE	CODE	DOC. NUMBER	REV
A3	CS	1310A20305	A02

CHANGE by *Drawer Name* 20-Apr-2006 SHEET 48 OF 69



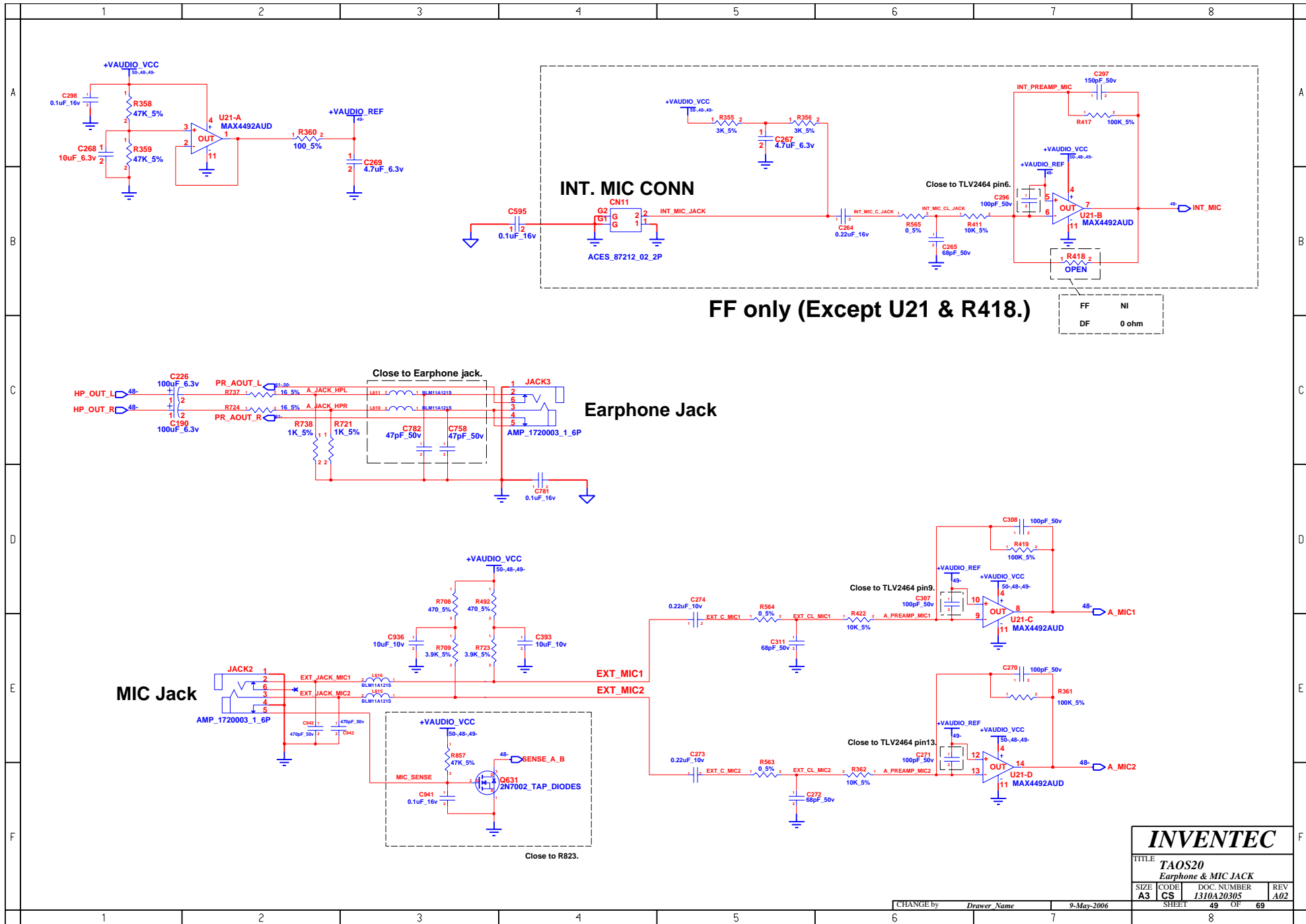

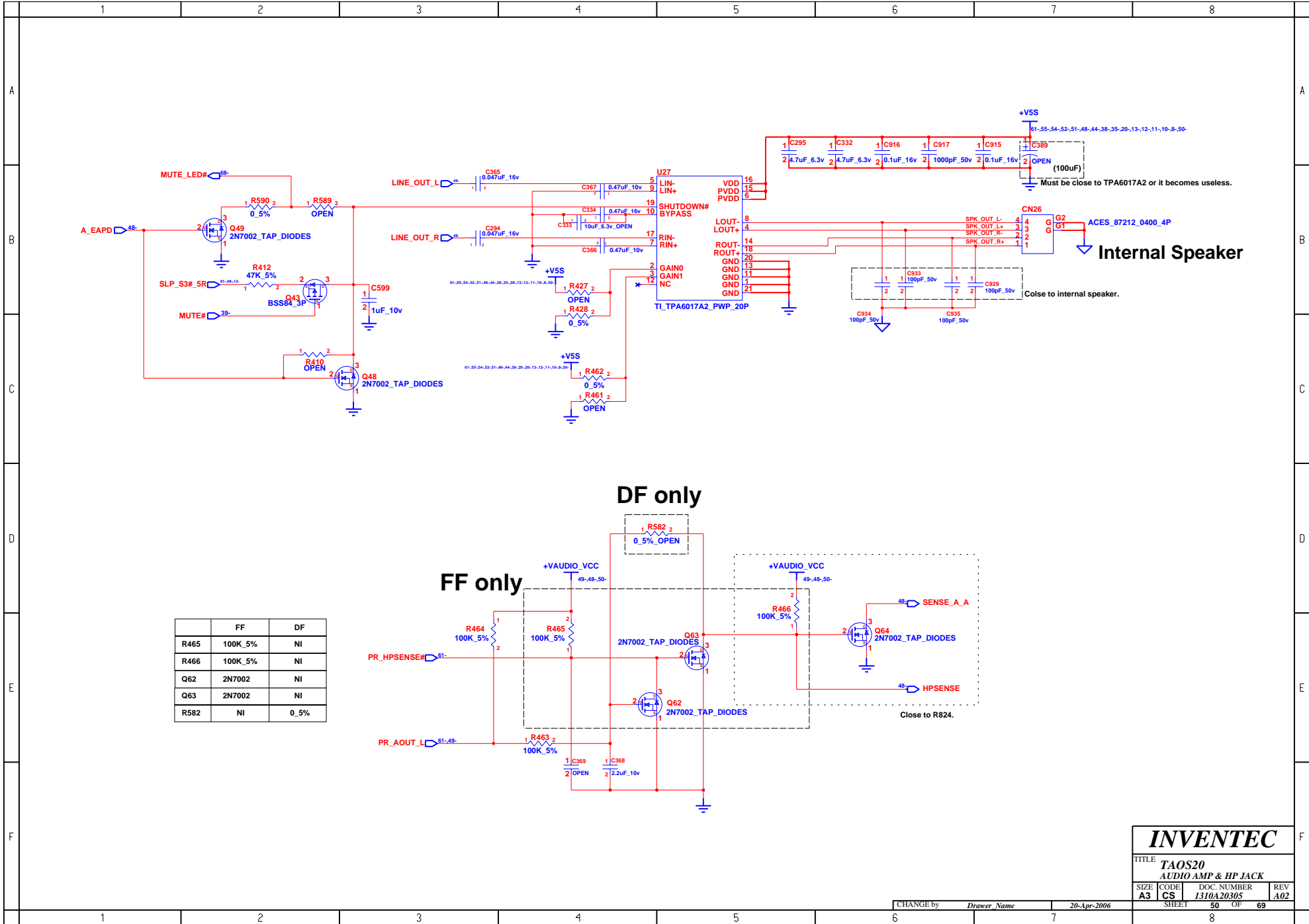

**INVENTEC**

TITLE			
TAOS20			
AUDIO AMP & HP JACK			
SIZE	CODE	DOC. NUMBER	REV
A3	CS	I310A20305	A02

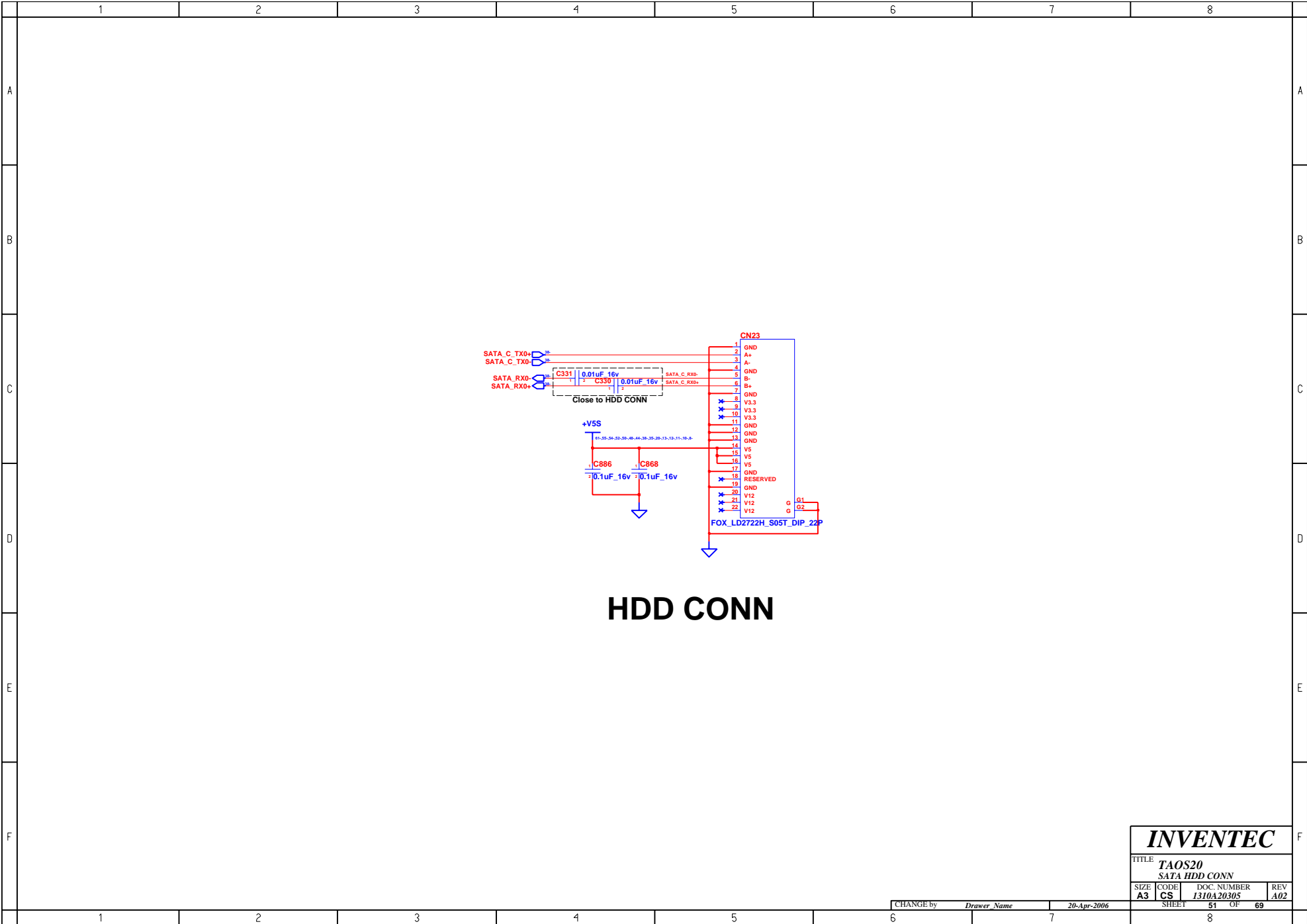

# HDD CONN

**INVENTEC**

TITLE			
TAOS20			
SATA HDD CONN			
SIZE	CODE	DOC. NUMBER	REV
A3	CS	1310A20305	A02

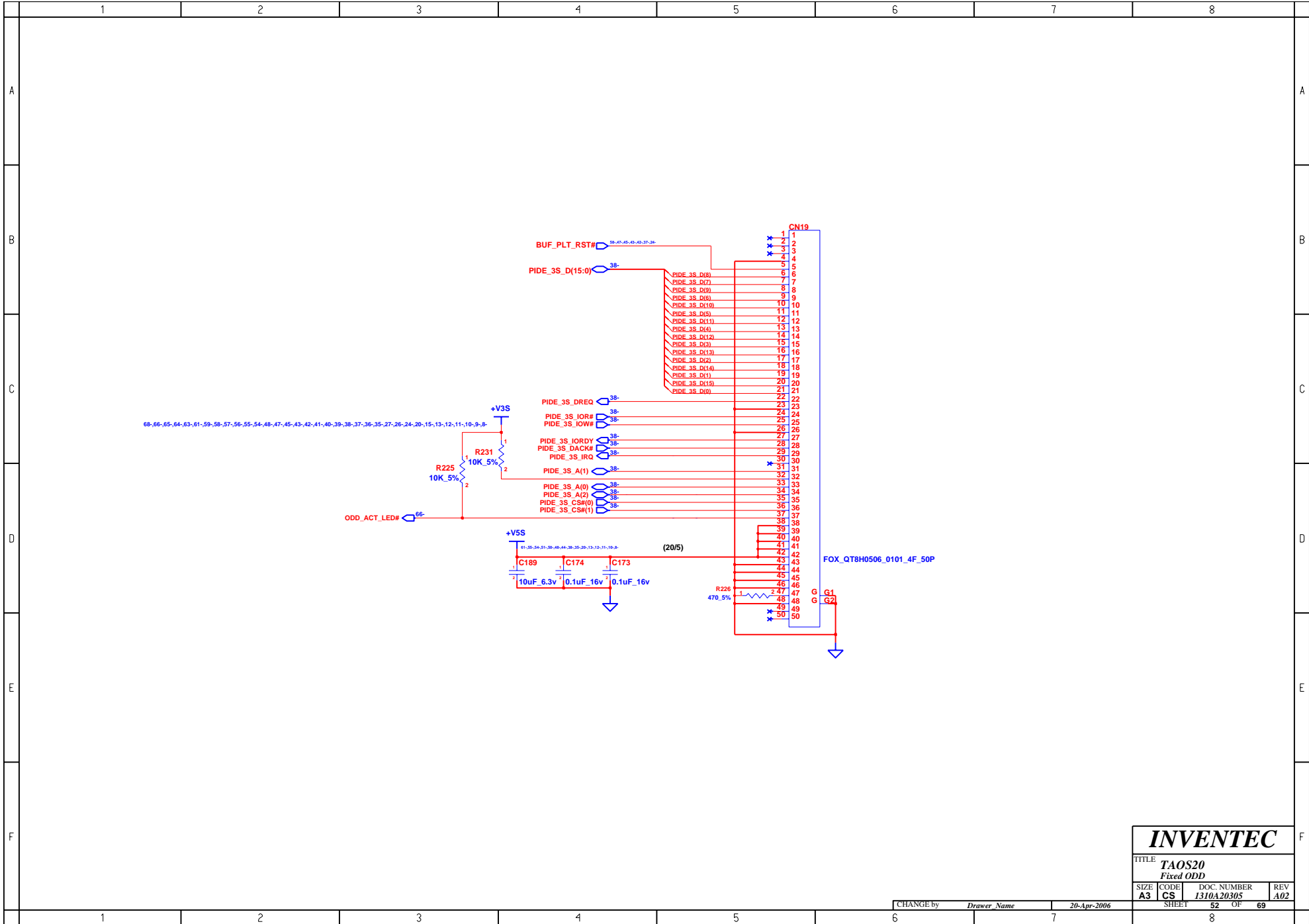

**INVENTEC**

TITLE TAOS20 Fixed ODD			
SIZE A3	CODE CS	DOC. NUMBER 1310A20305	REV A02
CHANGE by Drawer Name		20-Apr-2006	SHEET 52 OF 69

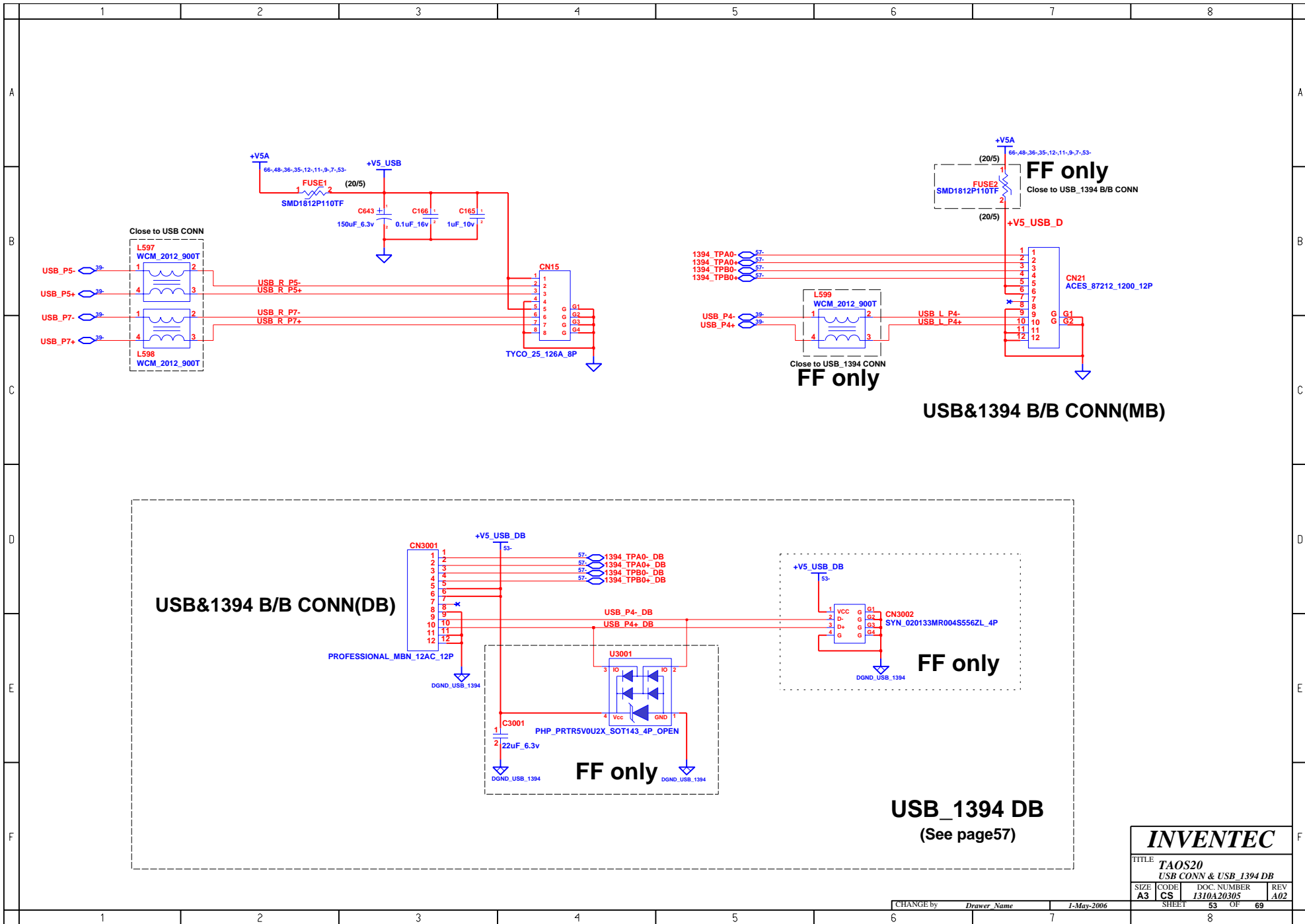

**INVENTEC**

TITLE			
TAOS20			
USB CONN & USB_1394 DB			
SIZE	CODE	DOC. NUMBER	REV
A3	CS	1310A20305	A02

CHANGE by *Drawer Name* 1-May-2006

SHEET 53 OF 69

FF: TI\_PCI7612  
DF: TI\_PCI4512

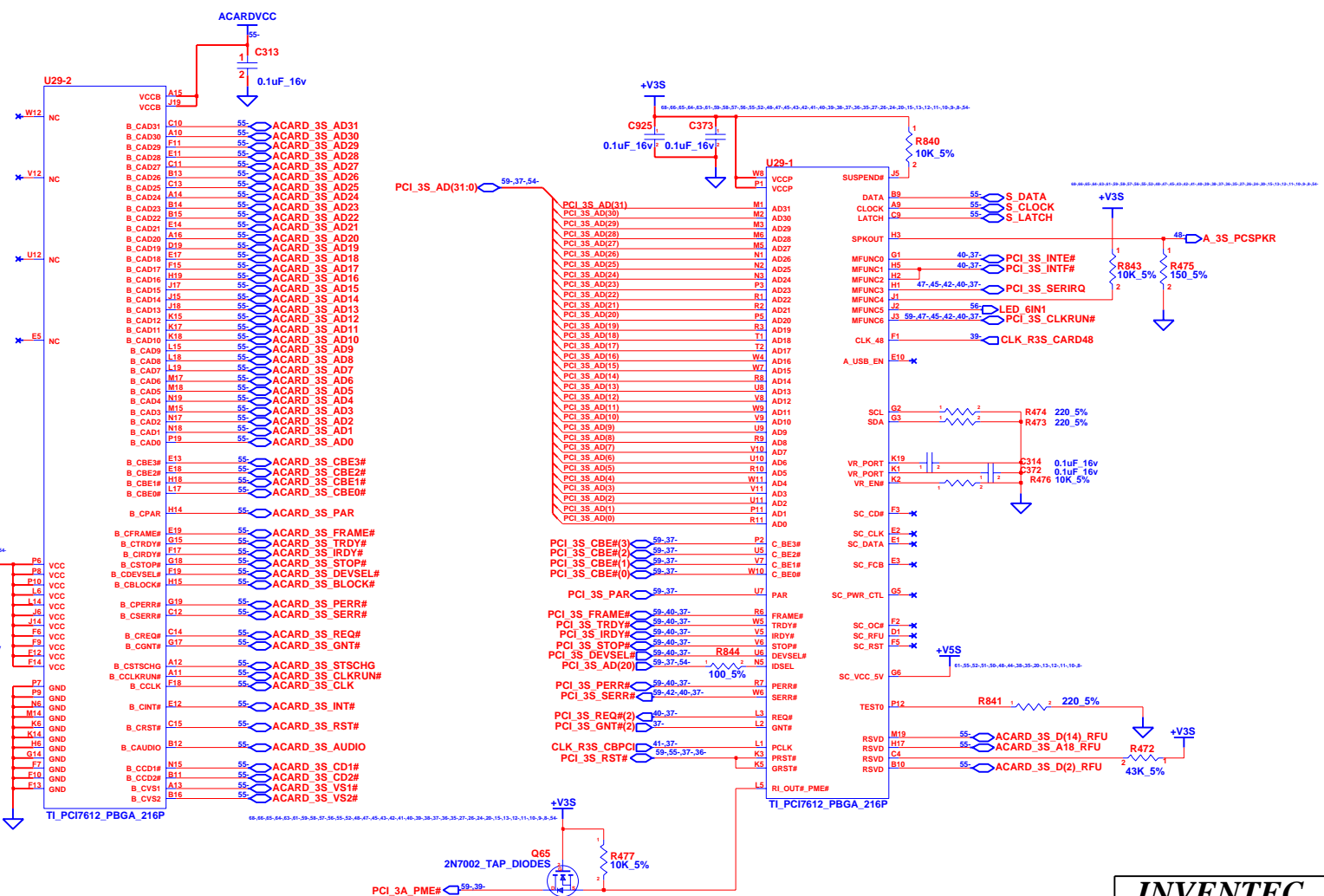

<b>INVENTEC</b>			
TITLE <b>TAOS20 CARDBUS CONTROLLER</b>			
SIZE <b>A3</b>	CODE <b>CS</b>	DOC. NUMBER <b>1310A20305</b>	REV <b>A02</b>
CHANGE by <i>Drawer Name</i>		20-Apr-2006	
SHEET		54 OF 69	

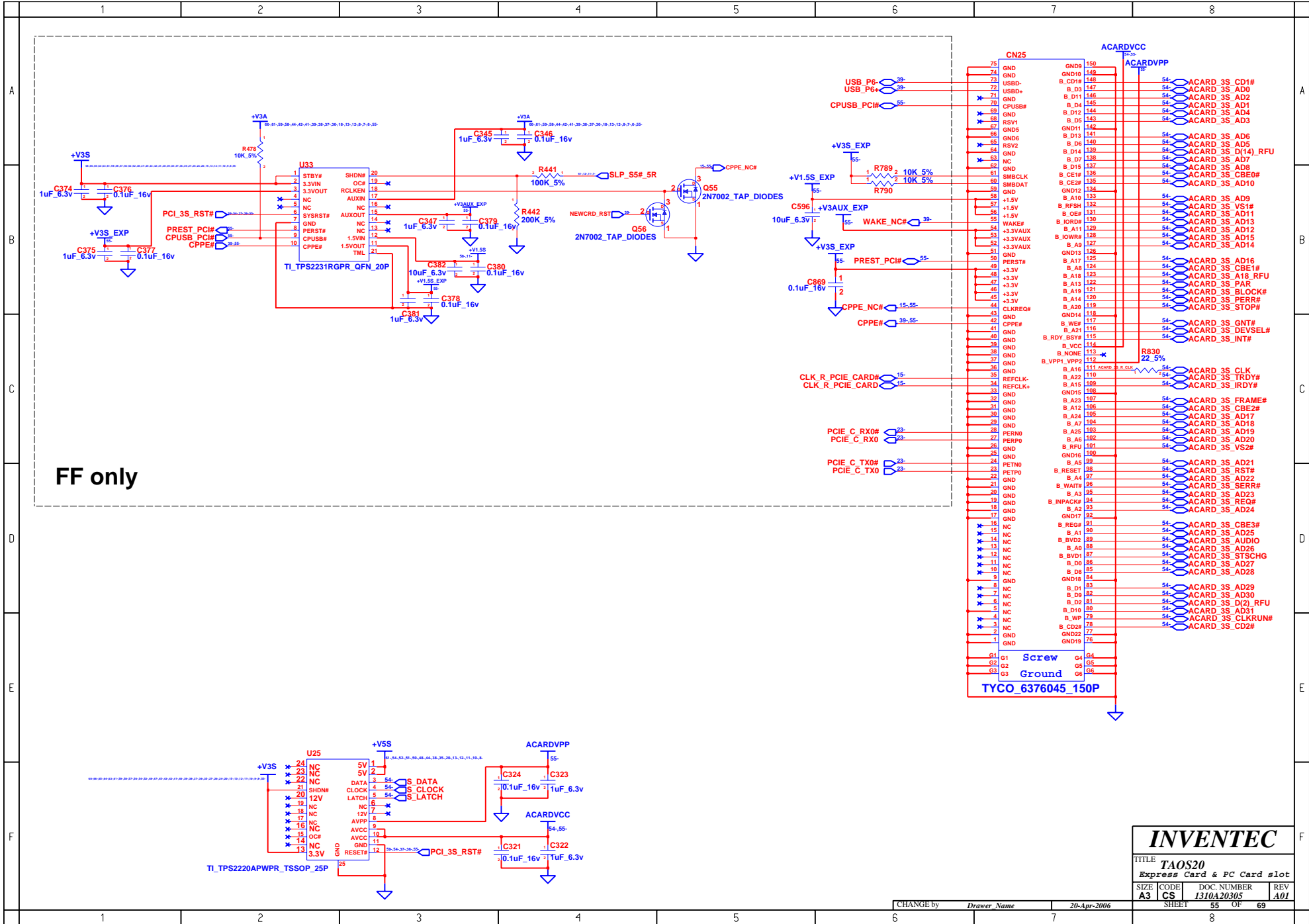

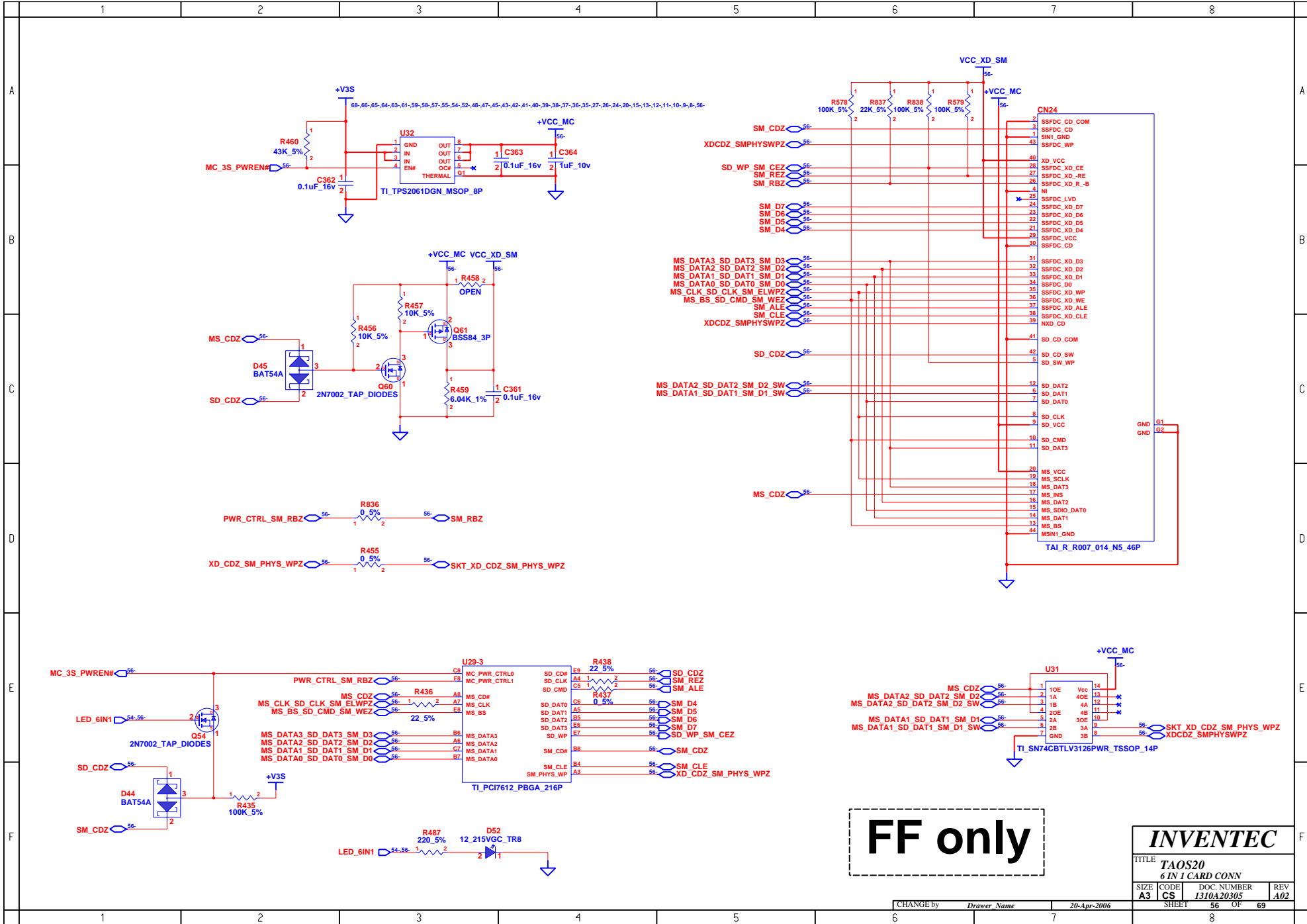



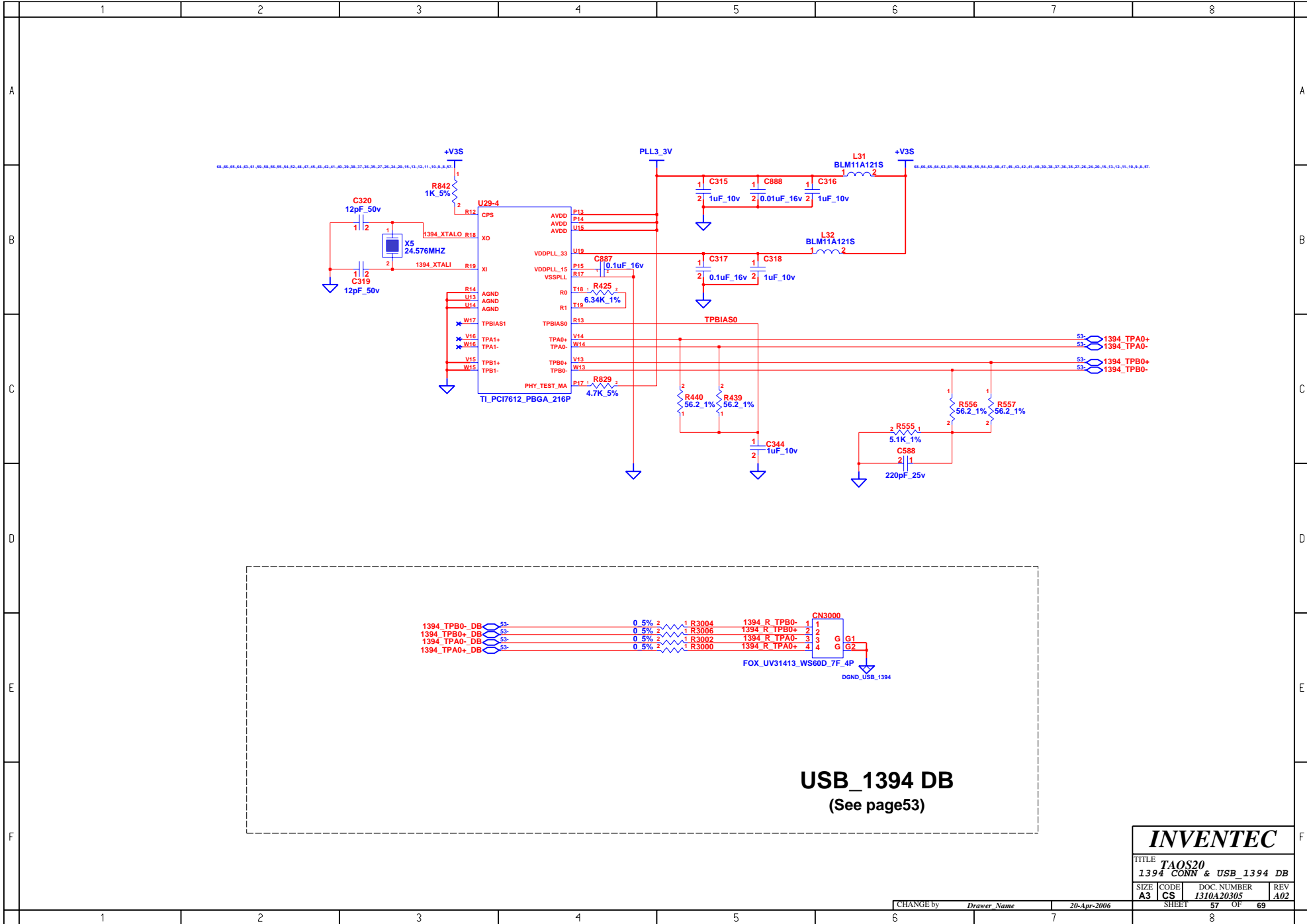

<b>INVENTEC</b>			
TITLE TAOS20			
1394 CONN & USB_1394 DB			
SIZE A3	CODE CS	DOC. NUMBER 1310A20305	REV A02
CHANGE by		Drawer Name	20-Apr-2006
SHEET 57		OF 69	

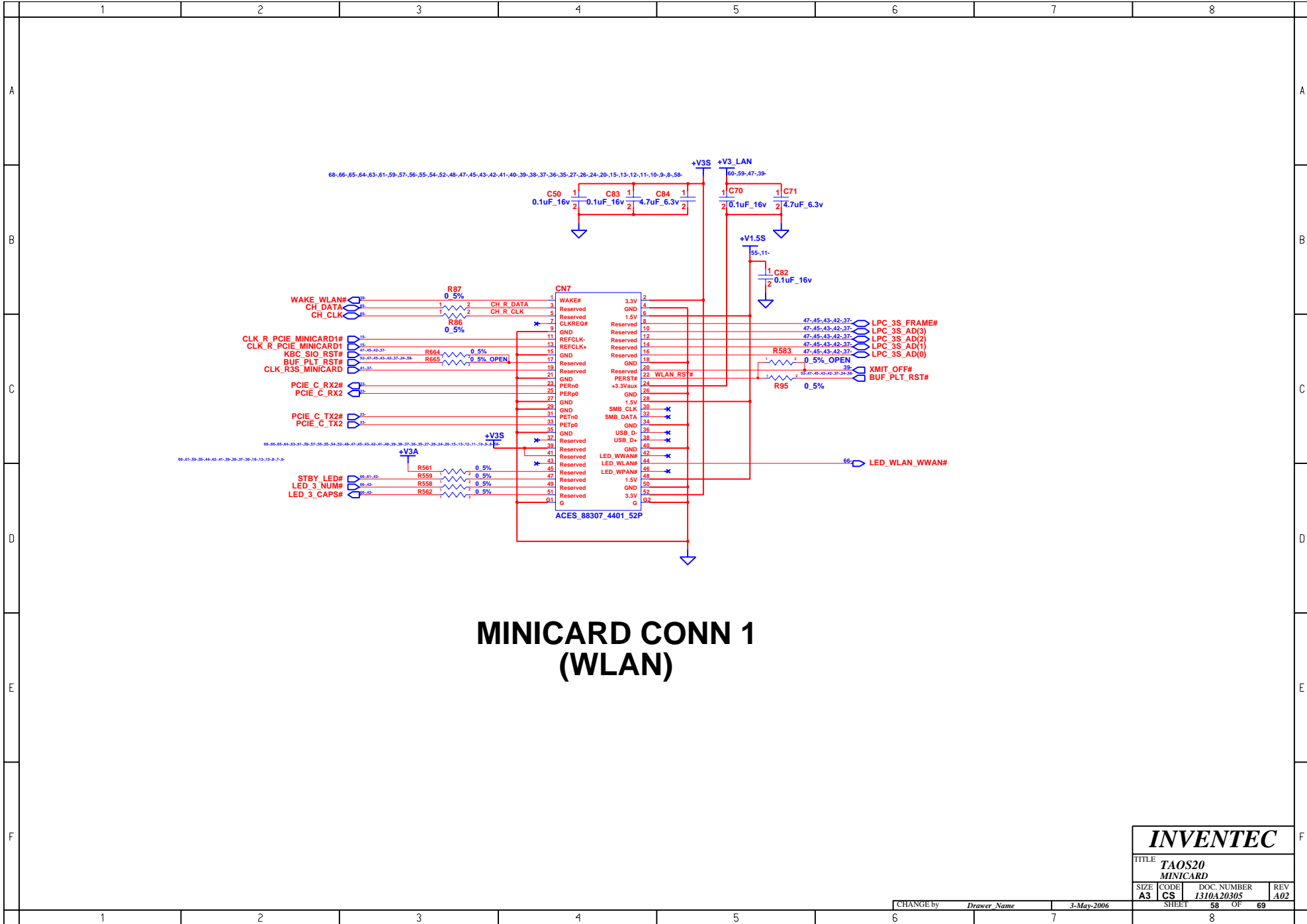

# MINICARD CONN 1 (WLAN)

**INVENTEC**

TITLE TAOS20 MINICARD

SIZE A3	CODE CS	DOC. NUMBER 1310A20305	REV A02
---------	---------	------------------------	---------

CHANGE by *Drawer Name* 3-May-2006

SHEET 58 OF 69

REF (U23)	(FF) BCM5788	(DF) BCM4401
R344	NI	0.5%
R382	0.5%	NI
Q57	BCP69	NI
Q58	BCP69	NI
R443	1K_5%	NI
R444	1K_5%	NI
R445	1K_5%	NI
U26	AT24C64A	NI
U30	NI	AT93C46A
R832	NI	0.5%
C897	0.01uF_16V	NI
C894	0.01uF_16V	NI
C903	0.01uF_16V	NI

Lead Free Parts  
 FF:BCM5788MKFBG  
 DF:BCM4401KFBG

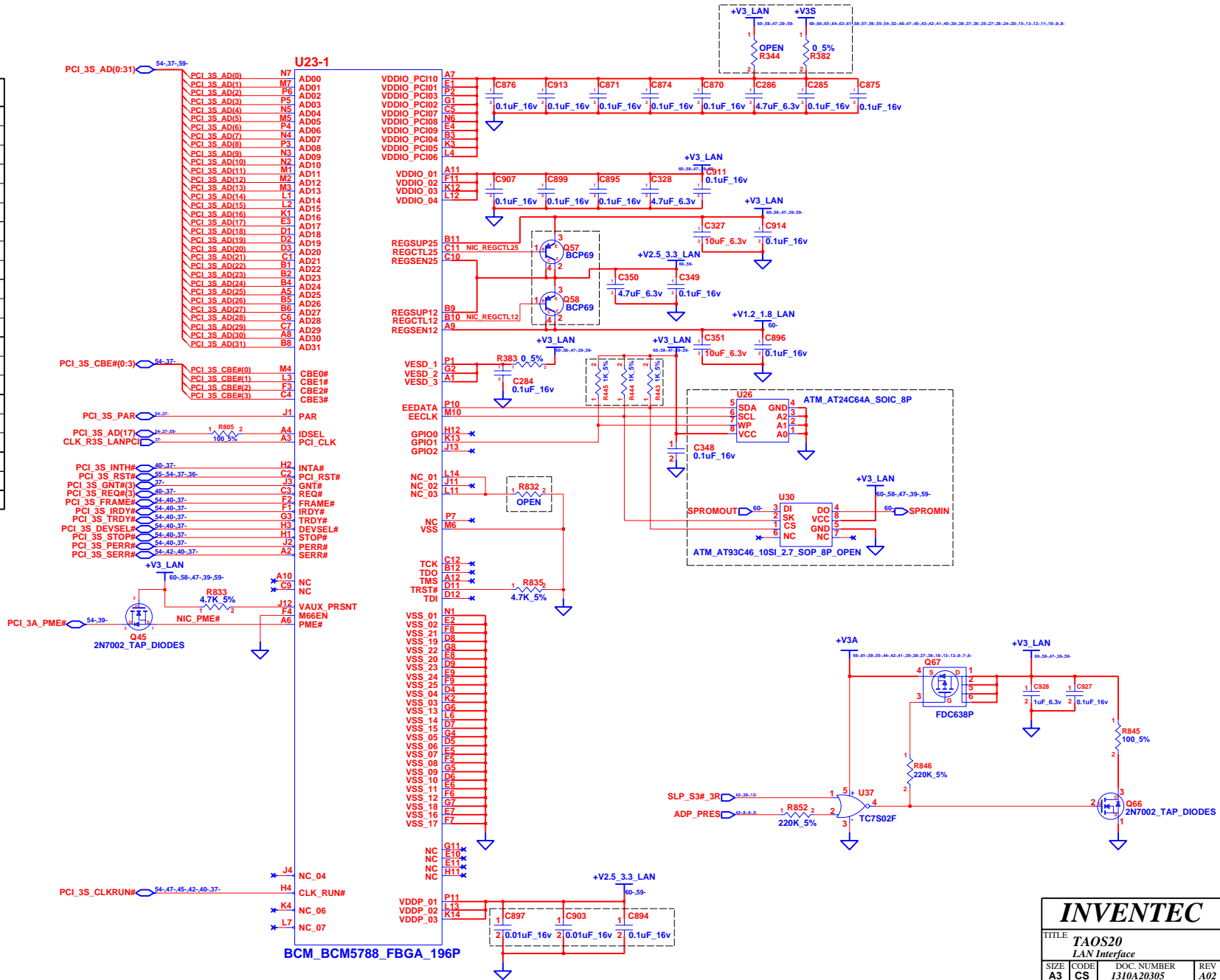

<b>INVENTEC</b>			
TITLE TAOS20 LAN Interface			
SIZE A3	CODE CS	DOC. NUMBER I310A20305	REV A02
CHANGE by Drawer Name		20-Apr-2006	
SHEET 59		OF 69	

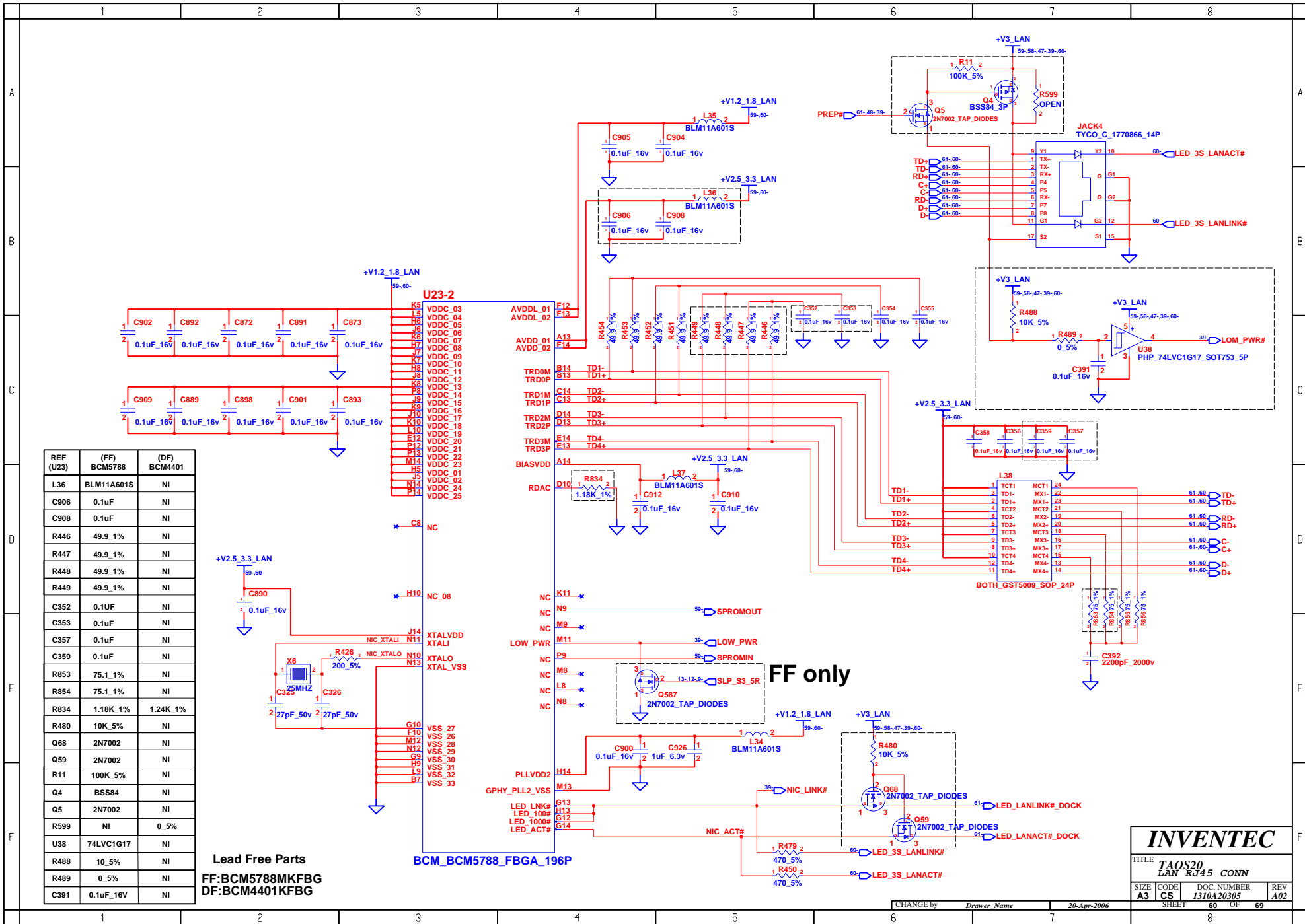

REF (U23)	(FF) BCM5788	(DF) BCM4401
L36	BLM11A601S	NI
C906	0.1uF	NI
C908	0.1uF	NI
R446	49.9_1%	NI
R447	49.9_1%	NI
R448	49.9_1%	NI
R449	49.9_1%	NI
C352	0.1uF	NI
C353	0.1uF	NI
C357	0.1uF	NI
C359	0.1uF	NI
R853	75.1_1%	NI
R854	75.1_1%	NI
R834	1.18K_1%	1.24K_1%
R480	10K_5%	NI
Q68	2N7002	NI
Q59	2N7002	NI
R11	100K_5%	NI
Q4	BSS84	NI
Q5	2N7002	NI
R599	NI	0.5%
U38	74LVC1G17	NI
R488	10_5%	NI
R489	0.5%	NI
C391	0.1uF_16V	NI

Lead Free Parts  
 FF:BCM5788MKFBG  
 DF:BCM4401KFBG

BCM\_BCM5788\_FBGA\_196P

FF only

<b>INVENTEC</b>			
TITLE TAOS20 LAN RJ45 CONN			
SIZE A3	CODE CS	DOC NUMBER 1310A20305	REV A02
CHANGE by Drawer Name		20-Apr-2006	SHEET 60 OF 69

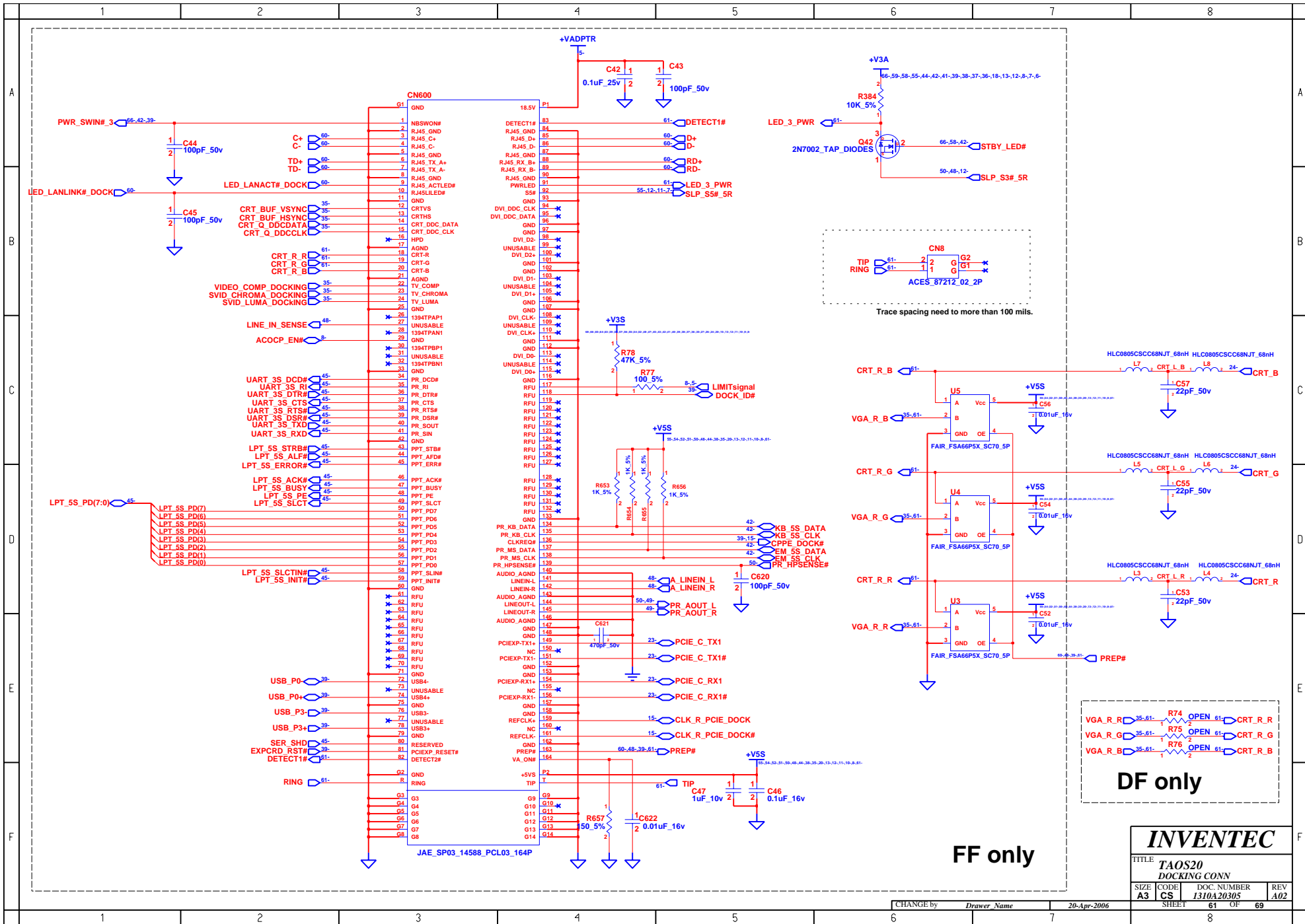

FF only

<b>INVENTEC</b>			
TITLE <b>TAOS20 DOCKING CONN</b>			
SIZE <b>A3</b>	CODE <b>CS</b>	DOC. NUMBER <b>1310A20305</b>	REV <b>A02</b>
SHEET <b>61</b>		OF <b>69</b>	

CHANGE by *Drawer Name* 20-Apr-2006

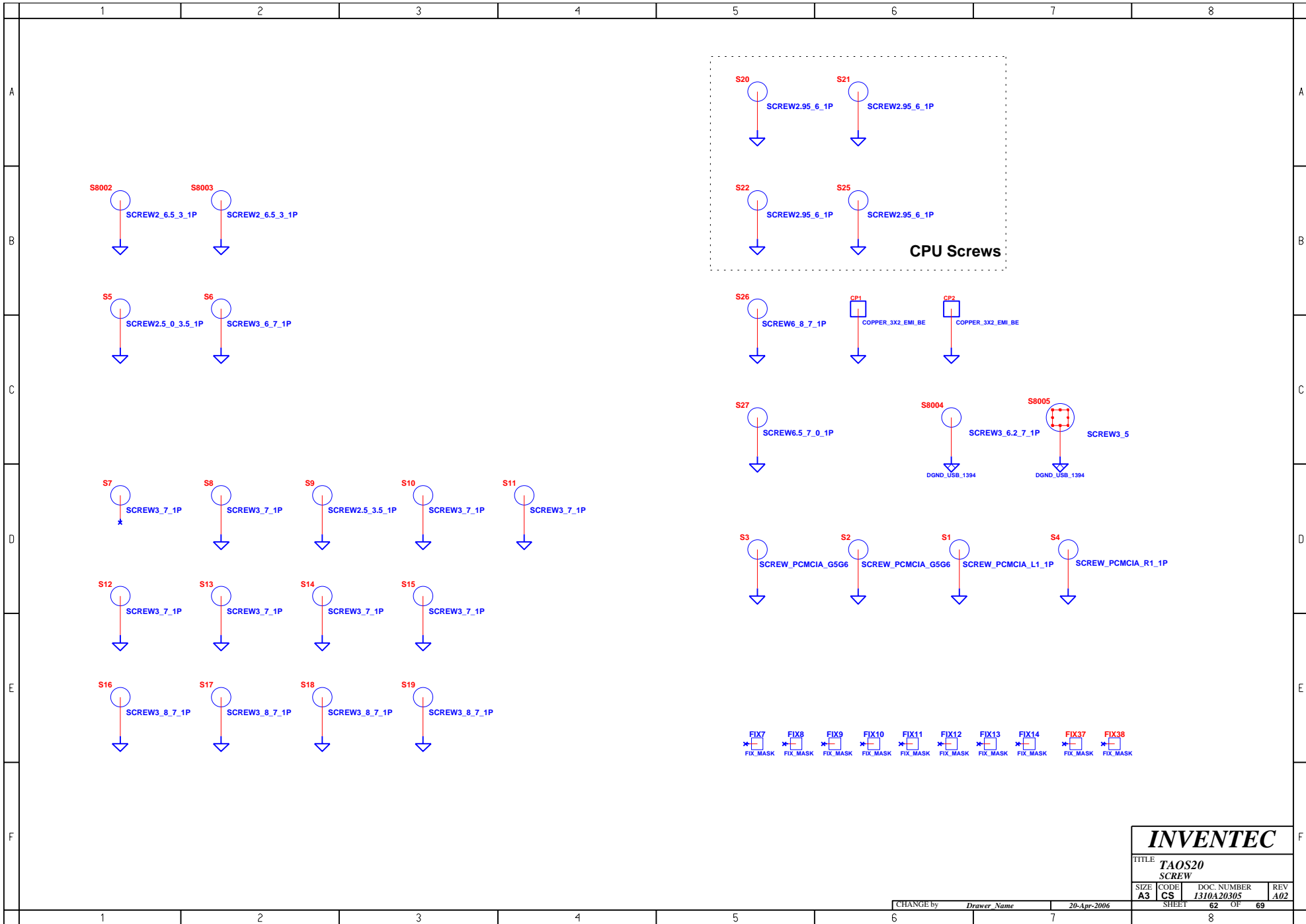

**INVENTEC**

TITLE  
**TAOS20  
 SCREW**

SIZE <b>A3</b>	CODE <b>CS</b>	DOC. NUMBER <b>1310A20305</b>	REV <b>A02</b>
-------------------	-------------------	----------------------------------	-------------------

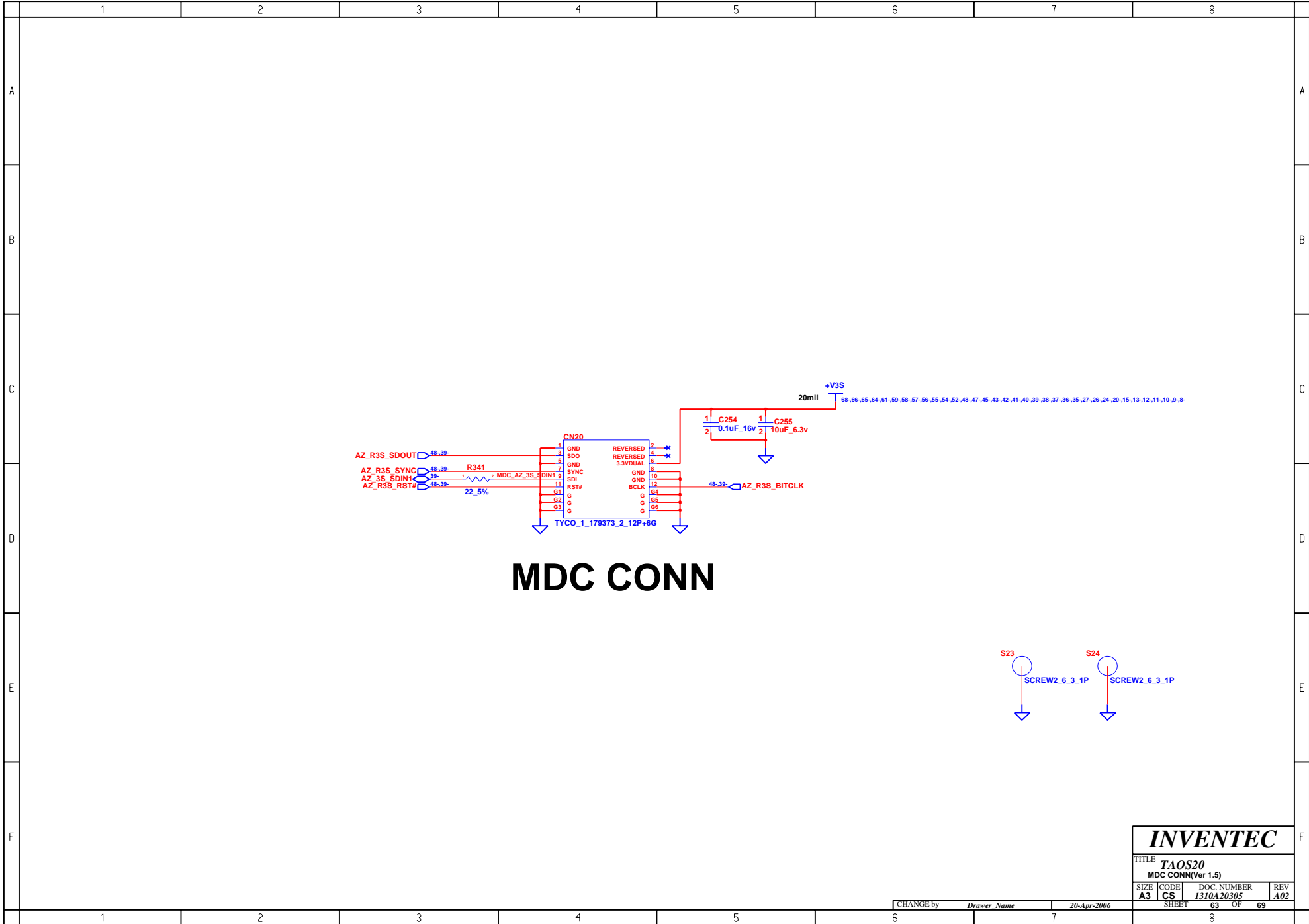

# MDC CONN

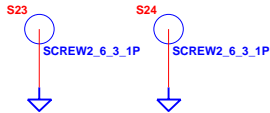

**INVENTEC**

TITLE TAOS20			
MDC CONN(Ver 1.5)			
SIZE A3	CODE CS	DOC. NUMBER 1310A20305	REV A02

CHANGE by *Drawer Name* 20-Apr-2006

SHEET 63 OF 69

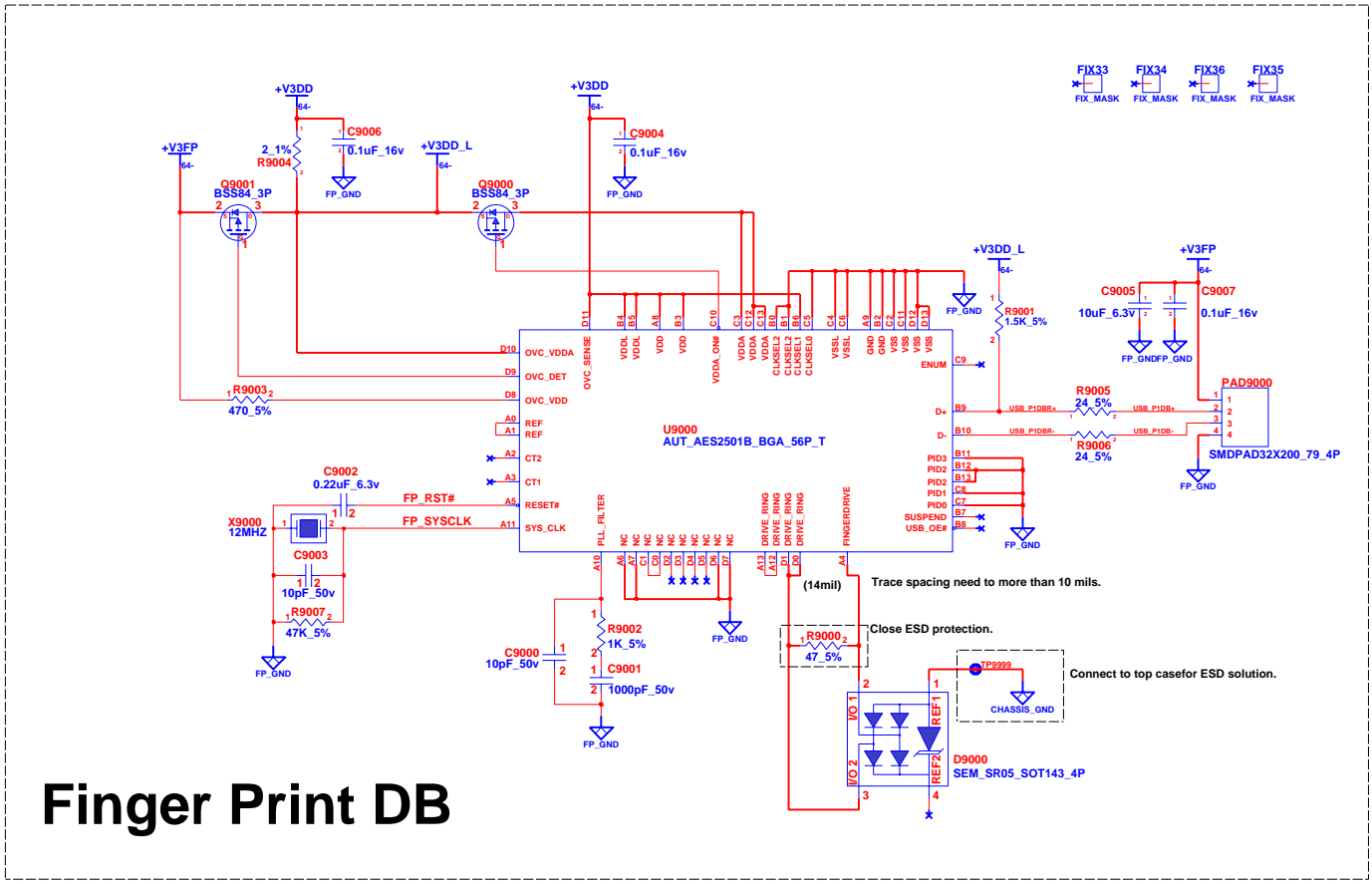

# Finger Print DB

**FF only**

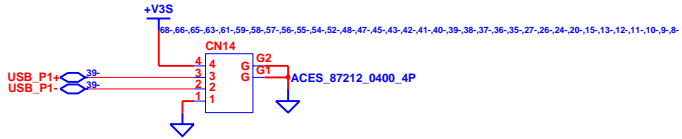

<b>INVENTEC</b>			
TITLE <b>TAOS20</b> Fingerprint			
SIZE <b>A3</b>	CODE <b>CS</b>	DOC. NUMBER <b>1310A20522</b>	REV <b>A01</b>
CHANGE by <i>Drawer Name</i>		20-Apr-2006	
SHEET		64 OF 69	



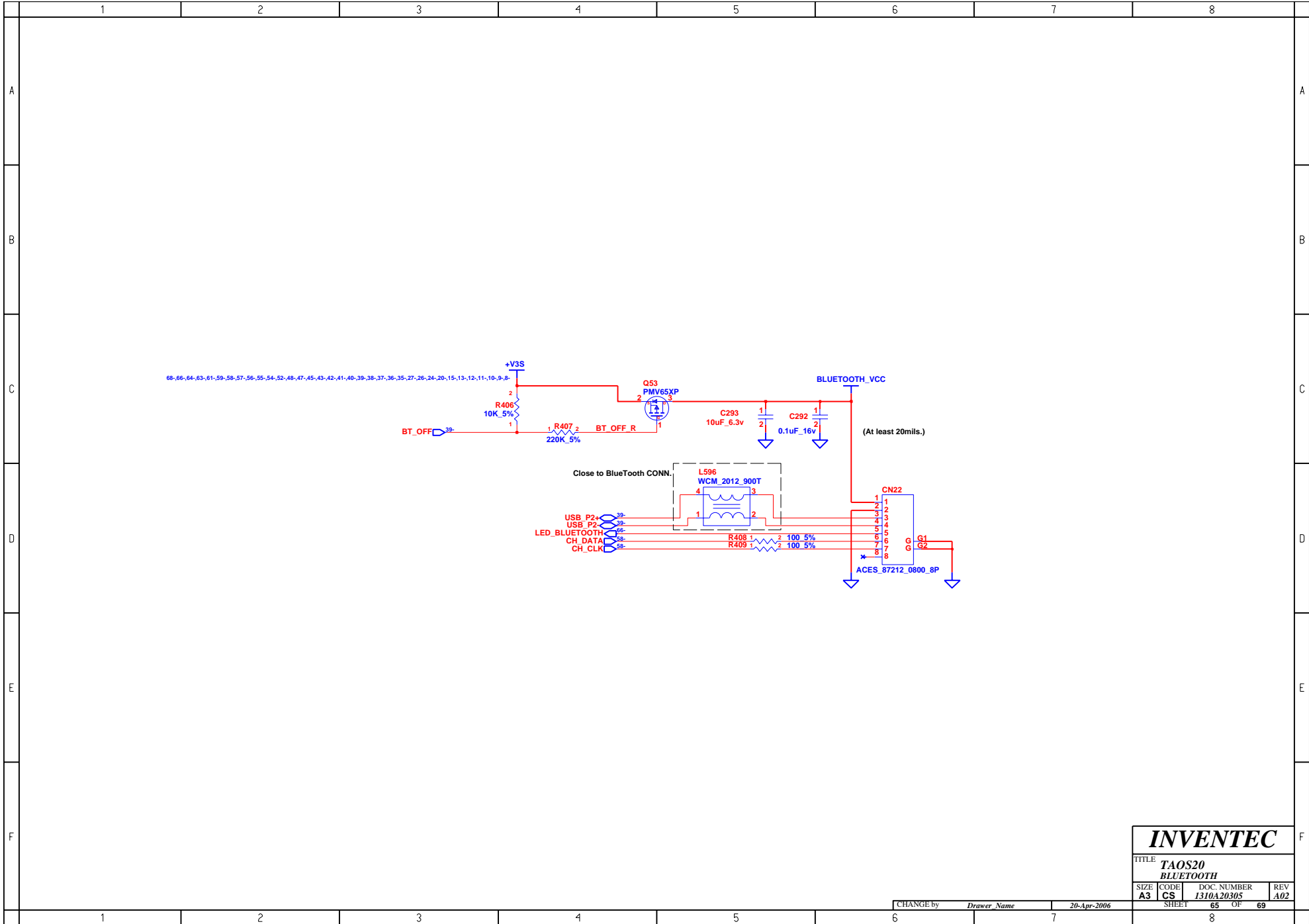

**INVENTEC**

TITLE  
**TAOS20  
 BLUETOOTH**

SIZE <b>A3</b>	CODE <b>CS</b>	DOC. NUMBER <b>1310A20305</b>	REV <b>A02</b>
-------------------	-------------------	----------------------------------	-------------------

CHANGE by *Drawer Name* 20-Apr-2006

SHEET 65 OF 69

### LID SW

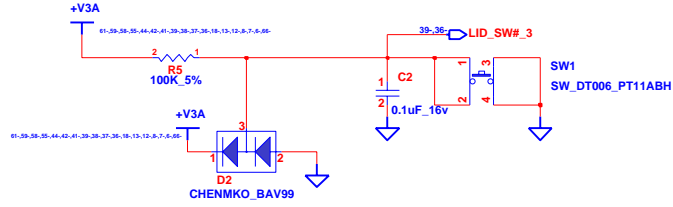

### Power SW

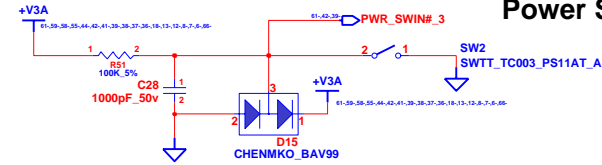

### DF only

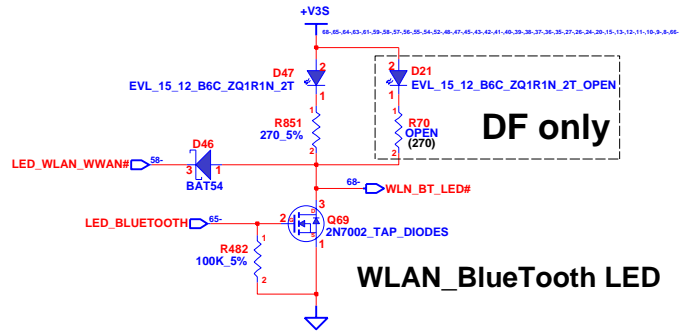

### WLAN\_BlueTooth LED

### Power / Standby LED

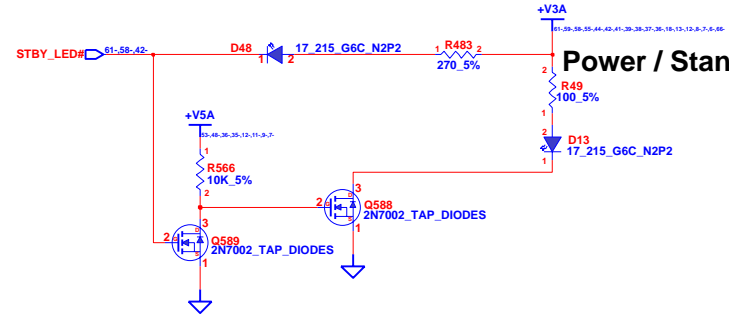

### WLAN\_BlueTooth SW

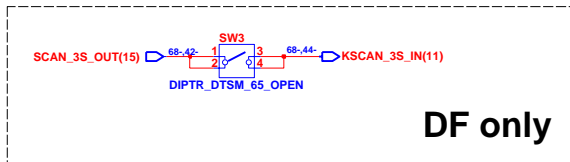

### Battery-Charge LED

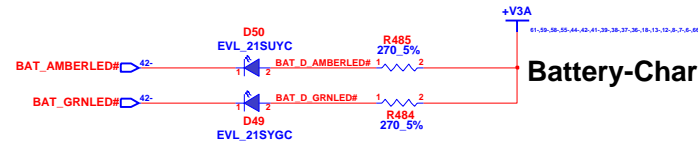

### HDD & ODD LED

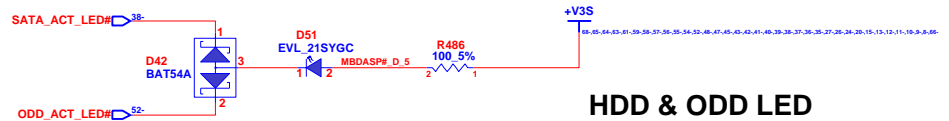

### CAP LOCK LED

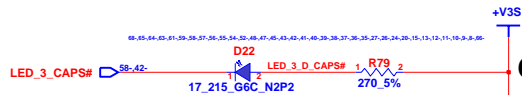

### NUM LOCK LED

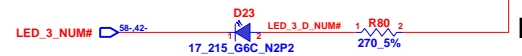

### Accelerometer LED (NI)

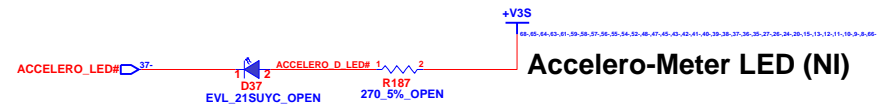

## INVENTEC

TITLE TAOS20 LID/POWER SWITCH & LED			
SIZE A3	CODE CS	DOC. NUMBER I310A20305	REV A02

**BLANK**

**INVENTEC**

TITLE			
TAOS20			
BLANK			
SIZE	CODE	DOC. NUMBER	REV
A3	CS	1310A20305	A02
SHEET		67	OF 69

CHANGE by *Drawer Name* 20-Apr-2006

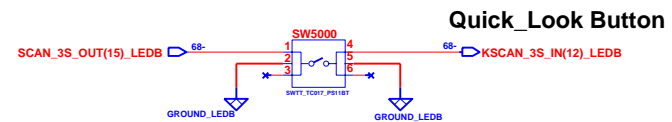
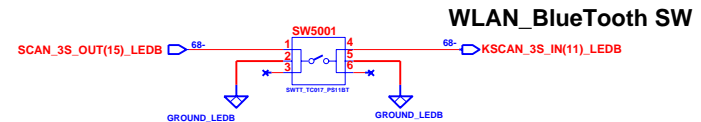
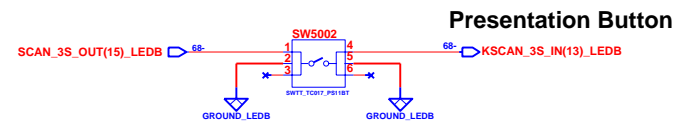
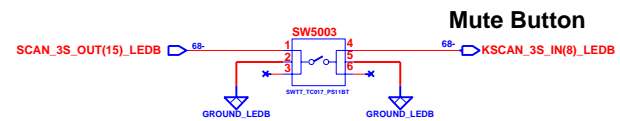
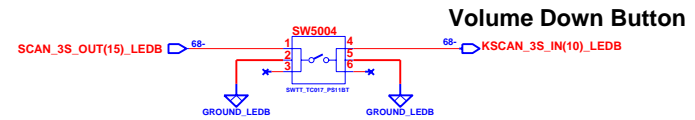
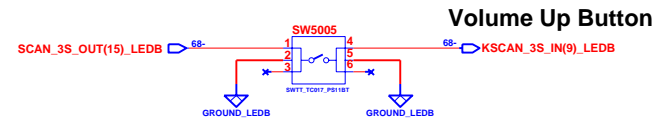
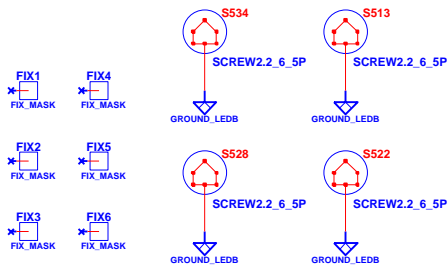
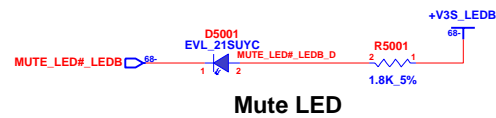
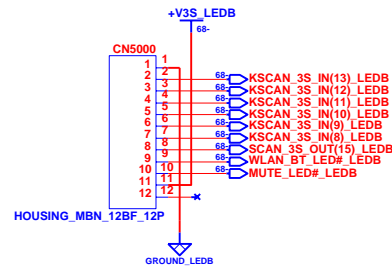
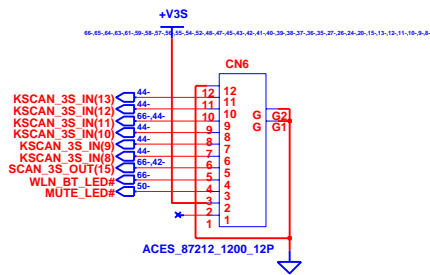

# Switch Button DB

**FF only**

**INVENTEC**

TITLE			
TAOS20			
LED/SWITCH BOARD			
SIZE	CODE	DOC. NUMBER	REV
A3	CS	1310A20305	A02

CHANGE by	Drawer Name	3-May-2006	SHEET	68	OF	69
-----------	-------------	------------	-------	----	----	----

### 1394\_USB cable

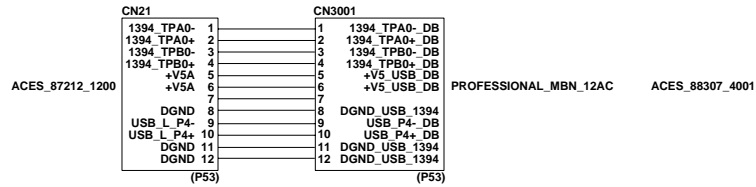

### LCM cable

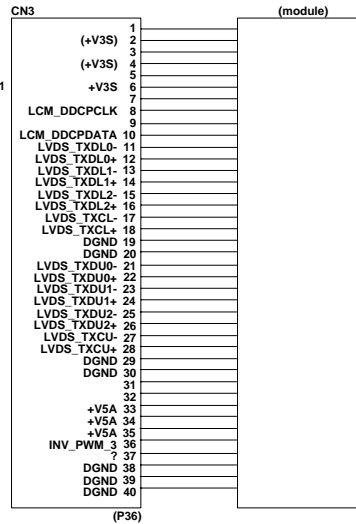

### TouchPad cable

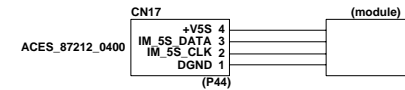

### SW/B cable

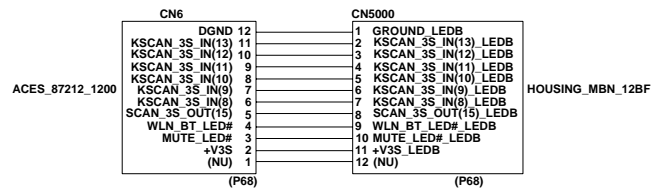

### INT\_Speaker cable

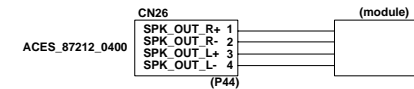

### INT\_MIC cable

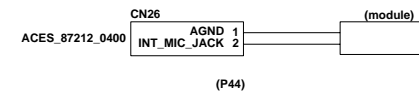

### Keyboard cable

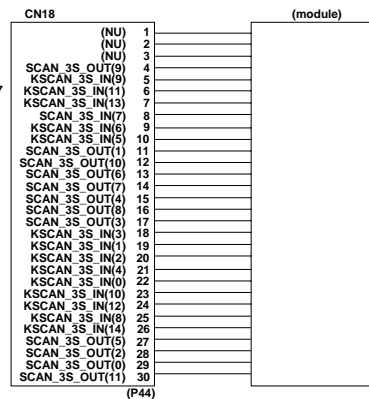

### Bluetooth cable

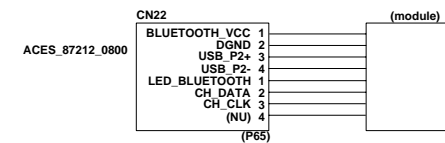

### Fingerprint cable

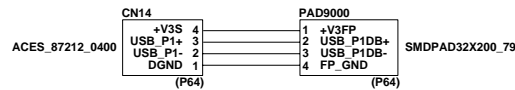

### MODEM cable

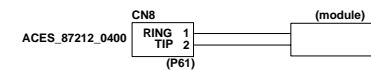

**INVENTEC**

TITLE TAOS20			
Cable Relation			
SIZE A3	CODE CS	DOC. NUMBER 1310A20305	REV A02

CHANGE by TAOS20 24-Apr-2006

SHEET 69 OF 69